

APPENDIX



**BICYCLE &
PEDESTRIAN
DESIGN GUIDE**

Bicycle and Pedestrian Design Guide



2011

Oregon Department of Transportation

OREGON BICYCLE AND PEDESTRIAN DESIGN GUIDE

OREGON HIGHWAY DESIGN MANUAL APPENDIX L

Copyright © 2011 (*3rd Edition*) by the Oregon Department of Transportation.
Permission is given to quote and reproduce parts of
this document if credit is given to the source.



OREGON DEPARTMENT OF TRANSPORTATION
BICYCLE AND PEDESTRIAN PROGRAM

ACKNOWLEDGEMENTS

OREGON TRANSPORTATION COMMISSION

Pat Egan, *Chair*
David Lohman
Mary Olson
Mark Frohnmayer
Tammy Baney

OREGON BICYCLE AND PEDESTRIAN ADVISORY COMMITTEE:

AJ Zelada, *OD Chair*
Lee Shoemaker, *Vice-Chair*
Erin Kelley
Jenna Stanke
Jerry Norquist
Wayne Baum
Maureen Sevigny
Daniel Ronan

OREGON DEPARTMENT OF TRANSPORTATION STAFF:

Sheila Lyons, *Bicycle and Pedestrian Program Manager*
Cathy Sattergren, *Graphic Artist*
Rodger Gutierrez, *Bicycle and Pedestrian Facilities Specialist*

Special thanks to the hundreds of people (the citizens of Oregon, local and ODOT staff) who contributed their ideas and recommendations regarding bicycle and pedestrian transportation.

TABLE OF CONTENTS

INTRODUCTION.....	I-1
The Importance of Good Design and Context	I-1
Context Sensitive Design	I-2
Bicyclists and Pedestrians: Similarities & Differences.....	I-4
Bicyclists	I-5
Pedestrians.....	I-5
Design Standards	I-6
Standards and Minimums.....	I-7
Innovative Designs.....	I-7
Planning Issues that Impact walkway and bikeway design	I-8
Land Use and Site Design	I-8
Interconnected Streets	I-8
Access Management (AM).....	I-10
Public Transit.....	I-12
CHAPTER 1: ON-ROAD BIKEWAYS.....	1-1
Types of Bikeways	1-1
Urban/Suburban Bike Facility Separation Matrix	1-2
Design Standards	1-5
Shared Roadways	1-5
Bicycle Boulevards	1-6
Shoulder Bikeways.....	1-8
Width.....	1-8
Pavement Design and Construction	1-8
Joint between the shoulders and the existing roadway	1-9
Gravel Driveways and Approaches	1-10
Bike Lanes	1-10
Width.....	1-11
Bike Lanes On One-Way Streets	1-11
Contra-Flow Bike Lanes	1-12
Bike Lanes and Diagonal Parking.....	1-13

Bike Lanes and Bus Lanes	1-14
Colored Bike Lanes.....	1-14
Colored Bike Lane “Narrows” Street	1-15
Surface Treatments.....	1-16
Surface Types.....	1-16
Chip Seals.....	1-16
Drainage Grates.....	1-16
Railroad Crossings	1-17
Crossing Surface	1-17
Crossing Angle.....	1-17
Flange Opening	1-18
Rumble Strips.....	1-18
Signing and Marking of Bikeways.....	1-19
Introduction	1-19
Shared Roadways	1-20
Signing	1-20
Bike Boulevards	1-22
Sharrows.....	1-22
Shoulder Bikeways.....	1-23
Signing	1-23
Marking.....	1-23
Bike Lanes	1-23
Bike Lane Designation.....	1-23
Stencil Placement.....	1-23
Intersections	1-24
Right Turn Lanes at Intersections	1-24
Reflectors.....	1-25
Special Use Signs	1-25
Railroad Crossing.....	1-25
Sidewalk Users.....	1-25
Bicycle Use of Push-Buttons	1-25
Bike Stencils at Intersections	1-25
Tunnels and Bridges.....	1-26

Touring Routes.....	1-26
Bicycle Races and Events	1-27
Temporary Work Zones	1-27
Innovative Designs.....	1-27
Advisory Bike Lanes.....	1-27
Bike Box.....	1-28
Bike Left Turn Lane.....	1-28
Bike Stair Channel	1-28
Bike Passing Lane	1-28
Bicycle Signal	1-28
Bike Friendly Transit Stop.....	1-29
Buffered Bike Lane.....	1-29
Choker/Separator.....	1-29
Cycle Track	1-29
Floating Bike Lane.....	1-30
Green Wave.....	1-30
Raised Bike Lanes.....	1-30
Skinny Street	1-31
Woonerf.....	1-31
Practices to be Avoided.....	1-31
Sidewalk Bikeways	1-31
Extruded Curbs.....	1-32
Reflectors and Raised Pavement Markers.....	1-32
Two-way Bike Lane	1-32
Continuous Right-Turn Lanes.....	1-32

CHAPTER 2: RESTRIPIING ROADS WITH BIKE LANES (ROAD DIETS) 2-1

Introduction	2-1
Reduce Lane Widths.....	2-2
Narrow Travel Lanes.....	2-2
Modify Parking.....	2-2
Reduce On-Street Parking	2-2
Remove Parking on One Side	2-3

Change From Diagonal to Parallel Parking	2-3
Narrow Parking Lanes.....	2-4
Replacing Lost Parking	2-4
Road Diets: Reduced Number of Travel Lanes	2-4
One-Way Couplets	2-5
Unbalanced Flow.....	2-6
Pavement Conditions.....	2-6
Width Constraints	2-7
Additional Benefits.....	2-7
Bike Lane Widths	2-8

CHAPTER 3: BICYCLE PARKING 3-1

Introduction	3-1
Recommended Standards	3-2
Dimensions.....	3-2
Covered Parking.....	3-2
Location.....	3-3
Bicycle Parking on Curb Extensions	3-4
On-Street Bicycle Parking	3-4
Number of Spaces	3-5
Signing.....	3-5
Other Recommendations	3-5

CHAPTER 4: WALKWAYS..... 4-1

Types of Walkways	4-1
Standards	4-2
Sidewalks.....	4-2
The Sidewalk Zone System.....	4-2
The Curb Zone	4-2
The Furniture Zone	4-2
The Pedestrian Zone	4-3
The Frontage Zone	4-6
Sidewalks Without Curb and Gutter	4-6

Sidewalks Behind the Ditch.....	4-6
Bridges	4-7
Surfacing	4-7
Thickness	4-8
Utility Vaults.....	4-8
Tree Well Grates	4-8
Pedestrian Rail	4-8
Pervious Sidewalk Surfaces	4-8
Railroad Crossings	4-9
Paths	4-9
Unpaved Paths.....	4-9
Paved Paths	4-9
Transit Stop Connections	4-10
Sidewalks	4-10
Bus Shelters.....	4-10
Bus Pullouts	4-11
Bus Curb Extensions.....	4-11
Transit Stop Crossings	4-12
Accommodating People with Disabilities.....	4-13
Width.....	4-13
Grades.....	4-13
Cross-Slope	4-14
Ramps	4-17
Ramp Types	4-17
Ramp Placement.....	4-19
Separated Sidewalks.....	4-19
Curb Tight Sidewalks.....	4-19
Ramp Elements	4-20
Pedestrians with Visual Impairments.....	4-20
Other Pedestrian Facilities	4-21
Benches	4-21
Awnings	4-21
Shelters	4-21

Landscaping	4-21
Drinking Water Fountains and Public Restrooms	4-22
Other Considerations.....	4-22
Driveways.....	4-22
Alleys	4-23
Signs.....	4-24
Directional/Wayfinding Signs.....	4-24
Street Signs	4-24
Practices to be Avoided.....	4-25
Meandering Sidewalks	4-25

CHAPTER 5: STREET CROSSINGS 5-1

Introduction	5-1
Crosswalks Defined.....	5-2
Legal Crossings	5-2
Planning and Design Issues that Affect Crossings.....	5-3
Level of Service (LOS), Speed and Appropriate Design Standards	5-3
Land Use.....	5-4
Transit Stops.....	5-4
Signal Spacing.....	5-4
Access Management.....	5-5
Out-of-Distance Travel	5-6
Midblock vs. Intersection Crossings	5-6
Maintenance	5-7
Crossing Solutions.....	5-7
Crosswalks.....	5-8
Crosswalk Striping	5-9
Advance Stop Lines	5-9
Signs	5-10
Textured and Colored Crosswalks	5-10
Illumination	5-12
Raised Medians and Refuge Islands	5-12
Curb Extensions	5-14

Pedestrian Signals	5-16
Rectangular Rapid Flashing Beacon (RRFB)	5-17
Two-Step Pedestrian Signal	5-17
Overcrossings and Undercrossings	5-18
Other Innovative Designs	5-19
Raised Crosswalks.....	5-19
Pedestrian Beacon	5-19

CHAPTER 6: INTERSECTIONS 6-1

Introduction	6-1
Bicyclists	6-1
Right-Turn Lanes.....	6-2
Other Right-Turn Lane Designs	6-2
Exceptions	6-3
Heavy Right Turns	6-3
Tee Intersections.....	6-4
Signals	6-4
Pedestrians	6-5
Minimizing Crosswalk Length.....	6-6
Truck Turning.....	6-7
Crosswalk Placement.....	6-7
Crosswalk Markings/Materials.....	6-8
Pedestrian Signal Head Placement.....	6-8
Push Button Placement.....	6-9
Islands and Refuges.....	6-9
Signals	6-11
Issues for Pedestrians and Bicyclists.....	6-13
Skewed Intersections.....	6-13
Multi-Leg Intersections	6-14
Dual Right-Turn Lanes.....	6-15
Modern Roundabouts	6-17
Interchanges.....	6-20
Introduction	6-20

Basic Principles	6-21
Guidelines	6-22
At-Grade Crossings	6-22
Grade-Separated Crossings	6-22
Single-Point Urban Interchange (SPUI).....	6-23
Merging and Exit Lanes	6-24
Right-Lane Merge	6-24
Exit Ramps	6-25
Other Innovative Designs	6-25
Bike Boxes	6-25
Raised Intersections.....	6-26

CHAPTER 7: SHARED USE PATHS.....7-1

Introduction	7-1
Shared Use Paths vs. Cycle Tracks	7-2
Important Considerations	7-2
Crossings	7-2
Access.....	7-2
Security.....	7-4
Maintenance	7-4
On-Street Facilities.....	7-4
Standards	7-4
Paths Next to Roadways	7-4
Concerns	7-4
Design Standards	7-5
Width and Clearances.....	7-6
Paths with Heavy Use	7-6
Lateral Clearance.....	7-7
Overhead Clearance	7-7
Separation from Roadway	7-7
Grades and Cross-Slope	7-7
Typical Pavement Sections	7-8
Drainage	7-8

Vegetation	7-8
Railings, Fences & Barriers	7-8
Illumination	7-10
Structures.....	7-11
Street Crossings.....	7-11
Minor Street Crossings.....	7-11
Major Street Crossings.....	7-12
Rails-to-Trails Crossings.....	7-13
Undercrossings vs. Overcrossings	7-13
Undercrossings.....	7-13
Overcrossings.....	7-14
Preventing Motor-Vehicle Access	7-15
Geometric Design.....	7-15
Bollards	7-15
Offset Fencing.....	7-16
Curb Ramps.....	7-17
Stairways	7-17
Signs	7-18
Regulatory Signs	7-18
Warning Signs	7-19
Path Crossing Roadway	7-20
Directional, Destination and Street Signs	7-20
End of Path.....	7-22
Placement of Signs	7-23
Striping	7-23

PHOTOS

Introduction

<i>A complete street accommodates all travel modes, supports residences and businesses and is a community asset</i>	I-1
<i>Context Sensitive Designs</i>	I-5
<i>Fast food with direct pedestrian access</i>	I-8
<i>Unlimited accesses increase conflict points</i>	I-10
<i>Well planned and situated bus stop</i>	I-13

Chapter 1

<i>A high volume urban street with bike lanes</i>	I-1
<i>Low volume residential shared roadway</i>	I-5
<i>Street too busy for shared roadway</i>	I-6
<i>Traffic diverter limits motor vehicle traffic while allowing bicycles to proceed thru</i>	I-7
<i>Bicyclist waits at island to cross busy street</i>	I-7
<i>Mini circle slows traffic, creating conditions needed for shared roadway</i>	I-7
<i>Higher volume rural road with shoulders</i>	I-9
<i>Paved driveway apron keeps gravel off shoulder</i>	I-10
<i>Typical bike lane on urban higher speed/volume roadway</i>	I-10
<i>Bike Lane on one way street</i>	I-12
<i>Contra-flow bike lane: One way for cars, two way for bicycles</i>	I-12
<i>Bike lane to left of bus lane</i>	I-14
<i>Colored bike lane “narrows” street</i>	I-15
<i>Concrete bike lane provides contrast with asphalt roadway</i>	I-15
<i>Chip seal ends at motor vehicle travel lane</i>	I-16
<i>Concrete RR crossing with rubber flanges</i>	I-17
<i>Rail crossing S curve</i>	I-18
<i>Bicycle unfriendly RR crossing</i>	I-18
<i>Profiled edge stripe</i>	I-19
<i>Well placed rumble strip leaves room for bicyclists</i>	I-19
<i>1st Generation bicycle boulevard pavement marking</i>	I-22
<i>2nd Generation bicycle boulevard pavement marking (indicates turn)</i>	I-22
<i>Sharrows indicate where bicyclists should position themselves in the roadway</i>	I-23
<i>Shoulder bikeway on higher volume rural road</i>	I-23
<i>Bike lane in temporary work zone</i>	I-27
<i>Advisory bike lane</i>	I-27
<i>Bike box</i>	I-28
<i>Bike left turn lane</i>	I-28
<i>Stair channel</i>	I-28
<i>Bike passing lane</i>	I-28

<i>Bike signal</i>	1-29
<i>Bicycle lane to rear of transit stop</i>	1-29
<i>Buffered bike lane</i>	1-29
<i>Choker/separator</i>	1-29
<i>Cycle track</i>	1-30
<i>Raised bike lane</i>	1-31
<i>Skinny street</i>	1-31
<i>Woonerf</i>	1-31

Chapter 2

<i>Bike lane restriped by narrowing travel lanes on commercial arterial</i>	2-1
<i>5 Lane roadway with wide lanes, no bike lanes</i>	2-2
<i>5 Lane roadway with bike lanes, narrowed motor vehicle lane</i>	2-2
<i>Parking removed from one side to add bike lane</i>	2-3
<i>Bike lanes added by narrowing parking lane</i>	2-4
<i>Parking bay</i>	2-4
<i>4 Lane undivided roadway</i>	2-5
<i>Restriped with bike lanes, center turn lane and pedestrian crossing</i>	2-5
<i>Road diet created room for median pedestrian refuge island</i>	2-5
<i>Removing a travel lane created room for a bike lane, curb extension and on street parking</i>	2-6
<i>Bike lanes striped on new pavement show up well</i>	2-7
<i>Bike lane provides minimal buffer for pedestrians</i>	2-8

Chapter 3

<i>Well placed bicycle parking</i>	3-1
<i>Upside down U or staple rack accommodates two bicycles</i>	3-1
<i>Bike racks can be street art</i>	3-2
<i>Covered bike parking</i>	3-3
<i>Bike racks placed out of pedestrian zone</i>	3-3
<i>Covered bike parking on curb extension</i>	3-4
<i>On-street bike parking</i>	3-4
<i>Secure bicycle parking in basement room</i>	3-5

Chapter 4

<i>A successful central business district depends on good sidewalk</i>	4-1
<i>Sidewalks serve pedestrians in urban and suburb contexts</i>	4-1
<i>Paths serve pedestrians in many contexts</i>	4-1
<i>Shoulders serve pedestrians in rural areas</i>	4-2
<i>A well organized furniture zone leaves the pedestrian zone clear of obstacles</i>	4-3
<i>5-Foot sidewalk is uncomfortably narrow</i>	4-4
<i>Sidewalk widened to 6-feet</i>	4-4
<i>Furniture zone eliminated at pinch point</i>	4-4

<i>Wheel stops prevent sidewalk encroachment.....</i>	<i>4-5</i>
<i>Sidewalk with no buffer</i>	<i>4-5</i>
<i>Central business districts require wider sidewalks</i>	<i>4-5</i>
<i>A generous frontage zone with seating and bus shelter.....</i>	<i>4-6</i>
<i>Frontage zone used for decorative planters</i>	<i>4-6</i>
<i>Sidewalk behind swale.....</i>	<i>4-7</i>
<i>Barrier curb.....</i>	<i>4-7</i>
<i>Pavers require regular maintenance to meet ADA requirements.....</i>	<i>4-8</i>
<i>Wheelchair traversable tree grates may extend into pedestrian zone</i>	<i>4-8</i>
<i>Concrete mix design is critical in pervious sidewalk to avoid a rough surface</i>	<i>4-9</i>
<i>Railroad crossing.....</i>	<i>4-9</i>
<i>Pedestrian crossing paired with transit stop.....</i>	<i>4-10</i>
<i>Bus stop with shelter in furniture zone</i>	<i>4-10</i>
<i>Bus shelter improves transit experience</i>	<i>4-11</i>
<i>Bus pull out.....</i>	<i>4-11</i>
<i>Curb extension bus stop reduces bus dwell time</i>	<i>4-12</i>
<i>Pedestrian crossing to rear of transit stop</i>	<i>4-13</i>
<i>Level landing provides resting area</i>	<i>4-14</i>
<i>Steep cross slope (4%) is difficult to traverse in a wheelchair.....</i>	<i>4-15</i>
<i>Separated sidewalk stays level at driveways and is free of obstacles</i>	<i>4-15</i>
<i>Sidewalk is kept level at driveway</i>	<i>4-15</i>
<i>Lowering the entire sidewalk should be a last resort.....</i>	<i>4-16</i>
<i>Wide sidewalk accommodates driveway and keeps pedestrian access route level.....</i>	<i>4-16</i>
<i>Furniture zone accommodates needed grade changes, keeping pedestrian zone level.....</i>	<i>4-17</i>
<i>“Standard” curb ramp</i>	<i>4-17</i>
<i>Parallel curb ramp</i>	<i>4-17</i>
<i>Perpendicular curb ramp</i>	<i>4-18</i>
<i>Curb ramp with one flare.....</i>	<i>4-18</i>
<i>Combination curb ramp.....</i>	<i>4-18</i>
<i>Ramp placement on separated sidewalk, note – outside flares are not required</i>	<i>4-19</i>
<i>Bus shelter in furniture zone.....</i>	<i>4-21</i>
<i>Bench in furniture zone.....</i>	<i>4-21</i>
<i>Awning shades sidewalk café.....</i>	<i>4-21</i>
<i>Landscaping provides storm water treatment</i>	<i>4-22</i>
<i>Dustpan style driveway approach improves pedestrian safety.....</i>	<i>4-22</i>
<i>Commercial right-in, right-out driveway.....</i>	<i>4-23</i>
<i>Commercial driveway with wrapped, level sidewalk and pork chop island.....</i>	<i>4-23</i>
<i>Sidewalk thru alley entrance is kept level.....</i>	<i>4-24</i>
<i>Meandering a sidewalk for no purpose should be avoided</i>	<i>4-25</i>

Chapter 5

<i>A successful pedestrian network requires safe and convenient crossing opportunities.....</i>	<i>5-1</i>
<i>Many crossings occur midblock out of convenience</i>	<i>5-1</i>

<i>Pedestrian crossings help shoppers access both sides of the street</i>	5-2
<i>Crossing the street is not a crime</i>	5-3
<i>A wide, multi-lane street built for motor vehicle capacity is difficult to cross</i>	5-4
<i>It is difficult to determine where pedestrians will cross on auto oriented streets</i> <i>with diffuse destinations</i>	5-4
<i>Traffic signal in distance creates adequate gaps for pedestrians to cross street</i>	5-4
<i>Painted crosswalk on two lane roadway is appropriate</i>	5-8
<i>Good pedestrian crossings on multilane roadways require more than just paint</i>	5-8
<i>Staggering markings place stripes out of wheel paths</i>	5-9
<i>Pedestrian crossing signs</i>	5-10
<i>Textured crosswalk, pedestrian view point</i>	5-11
<i>Drivers view of same crosswalk</i>	5-11
<i>Textured crosswalk with supplemental white markings</i>	5-11
<i>White markings inset into colored pavement</i>	5-12
<i>Median island provides mid-street refuge for pedestrians</i>	5-13
<i>Pedestrians waiting where curb extension could be</i>	5-14
<i>Motorist yields to pedestrians at curb extension</i>	5-15
<i>Curb extension provides room for bike parking</i>	5-15
<i>Slotted drain at retrofit curb extension</i>	5-16
<i>Rapid rectangular flashing beacon</i>	5-17
<i>Pedestrian undercrossing is open and inviting</i>	5-19
<i>Raised crosswalk</i>	5-19
<i>Pedestrian hybrid beacon or HAWK</i>	5-20

Chapter 6

<i>Large multi-lane intersections pose particular challenges for pedestrians and bicyclists,</i> <i>but solutions exist</i>	6-1
<i>Combined right turn lane and thru bike lane</i>	6-3
<i>Stencil indicates where to position bicycle over loop detector to trip signal</i>	6-4
<i>Truck negotiating turn</i>	6-7
<i>Pedestrian signal head in line with crosswalk</i>	6-8
<i>Pushbutton placed and aligned for the visually impaired</i>	6-9
<i>Tactile pedestrian push button</i>	6-9
<i>Cut thru pedestrian island</i>	6-11
<i>Countdown pedestrian signal head</i>	6-12
<i>LPI: Pedestrian phase precedes motor vehicle green phase by a few second</i>	6-12
<i>Skewed intersection results in long crosswalk and increased pedestrian exposure</i>	6-13
<i>Formerly skewed intersection realigned to right-angle</i>	6-14
<i>Blue bike lane thru skewed intersection</i>	6-14
<i>Modern roundabout in suburban context</i>	6-19
<i>Pedestrian crossing to splitter island at roundabout</i>	6-19
<i>Bicyclist in circulating roadway at roundabout</i>	6-19
<i>Bicyclist using exit ramp to access sidewalk</i>	6-20

<i>Bike box (bicyclists may continue straight)</i>	6-26
<i>Raised intersection keeps crossing level with sidewalk</i>	6-26

Chapter 7

<i>Paths accommodate many users</i>	7-1
<i>Paths are used by many non-motorized modes</i>	7-2
<i>Path connection to local street</i>	7-4
<i>Popular paths quickly become crowded</i>	7-6
<i>Gravel shoulders prevent raveling of path edges</i>	7-6
<i>Path striped to separate users</i>	7-7
<i>Double fencing makes users feel trapped</i>	7-9
<i>Gentle grassy slope eliminates the need for railing</i>	7-10
<i>Pedestrians stop to admire the view in widened area without impeding thru traffic</i>	7-11
<i>Path crossing a minor street should have been given priority right of way</i>	7-12
<i>Path is fully separated with an undercrossing</i>	7-13
<i>Undercrossing with good sight lines</i>	7-14
<i>Bollards are overused and can cause injury</i>	7-16
<i>Split path entry eliminates need for bollards</i>	7-16
<i>Offset fencing</i>	7-16
<i>Metal channel (in yellow) provided for bicycle access</i>	7-17

TABLES

<i>Table 1-1: Separation Context Matrix</i>	1-4
<i>Table 1-2: Rural road shoulder widths</i>	1-8

FIGURES

Introduction

<i>Figure I-1: Sample illustration from Main Street Handbook</i>	I-2
<i>Figure I-2: The Transect (Congress of New Urbanism)</i>	I-3
<i>Figure I-3: Streets can be made pleasant for all users</i>	I-6
<i>Figure I-4: Segregated land uses increase travel distances</i>	I-7
<i>Figure I-5: Mixed land use fosters walking and bicycling</i>	I-8
<i>Figure I-6: Disconnected streets increase travel distances</i>	I-9
<i>Figure I-7: Connected streets reduce travel distances, reduce traffic and increase mode choices</i>	I-9
<i>Figure I-8: Discontinuous streets linked with paths</i>	I-9
<i>Figure I-9: Consolidating accesses reduces conflict points, benefitting pedestrians, bicyclists and drivers</i>	I-10
<i>Figure I-10: Allowable movements at an intersection</i>	I-11
<i>Figure I-11: Severed connection eliminates conflicts</i>	I-11

Chapter 1

<i>Urban/Suburban Recommended Separation Matrix</i>	1-3
<i>Figure 1-1: Shared roadway</i>	1-5
<i>Figure 1-2: Wide curb lane</i>	1-6
<i>Figure 1-3: Elements of a bicycle boulevard</i>	1-7
<i>Figure 1-4: Shoulder bikeway</i>	1-8
<i>Figure 1-5: Saw cut before adding shoulder</i>	1-9
<i>Figure 1-6: Feathering a shoulder</i>	1-9
<i>Figure 1-7: Grinding and inlaying a shoulder</i>	1-10
<i>Figure 1-8: Gravel driveway paved to limit gravel on shoulders</i>	1-10
<i>Figure 1-9: Typical bike lane dimensions</i>	1-11
<i>Figure 1-10: Contra-flow bike lane reduces out of direction travel</i>	1-12
<i>Figure 1-11: Bike lane next to diagonal parking</i>	1-13
<i>Figure 1-12: Back in diagonal parking and bike lane</i>	1-13
<i>Figure 1-13: Bike lane to the left of bus lane</i>	1-14
<i>Figure 1-14: Colored bike lanes “narrow” roadway</i>	1-14
<i>Figure 1-15: Bicycle safe drainage grates</i>	1-17
<i>Figure 1-16: Curb inlet drainage grate</i>	1-17
<i>Figure 1-17: Bulged RR crossing</i>	1-18
<i>Figure 1-18: Bicycle friendlier rumble strips</i>	1-19
<i>Figure 1-19: W11-1 with riders</i>	1-20
<i>Figure 1-20: W16-1P</i>	1-20
<i>Figure 1-21: CW11-1</i>	1-20
<i>Figure 1-22: R4-11</i>	1-21
<i>Figure 1-23: D11-1</i>	1-21
<i>Figure 1-24: Bicycle route guide sign OBD1-3c</i>	1-21
<i>Figure 1-25: MUTCD Figure 9B-6 with Oregon Supplement OBD1 signs</i>	1-22
<i>Figure 1-26: Oregon standard bike lane marking</i>	1-23
<i>Figure 1-27: OBW1-9</i>	1-24
<i>Figure 1-28: Standard bike stencil</i>	1-24
<i>Figure 1-29: Bike stencil placed out of wheel path</i>	1-24
<i>Figure 1-30: R4-4</i>	1-25
<i>Figure 1-31: OBW8-19L</i>	1-25
<i>Figure 1-32: OBR10-13</i>	1-25
<i>Figure 1-33: R10-26</i>	1-25
<i>Figure 1-34: Bike symbol for loop detection placement</i>	1-26
<i>Figure 1-35: OBR 10-10 and OBW 1-8</i>	1-26
<i>Figure 1-36: OBD 11-3</i>	1-26
<i>Figure 1-37: OBM 1-8</i>	1-26
<i>Figure 1-38: Raised bike lane</i>	1-30

Figure 1-39: Conflicts with sidewalk riding..... 1-32

Figure 1-40: Ramp allows bicycle to access sidewalk on bridge..... 1-32

Figure 1-41: Problems with two-way bike lanes..... 1-33

Figure 1-42: Widening one side and moving center line results in proper bike lane Placement..... 1-33

Figure 1-43: Continuous right turn lane reconfigured..... 1-34

Chapter 2

Figure 2-1: Bike lanes added by narrowing travel lanes..... 2-2

Figure 2-2: Parking removed from one side 2-3

Figure 2-3: Restripe from diagonal to parallel parking..... 2-3

Figure 2-4: Bike lane added by narrowing parking..... 2-4

Figure 2-5: Parking bays..... 2-4

Figure 2-6: Road Diet – 4 motor vehicle lanes becomes 2 bike lanes and 3 motor vehicle lanes 2-5

Figure 2-7: Motor vehicle travel lane removed from 4-lane, one way street..... 2-6

Figure 2-8: 4-lane, two way street restriped with 2 lanes in one direction, 1 in the other and bike lanes..... 2-6

Figure 2-9: Motor vehicle travel lane offset by bike lane results in larger effective turn radius..... 2-7

Figure 2-10: Restriping offsets travel lanes reducing wear and tear..... 2-7

Chapter 3

Figure 3-1: Recommended bicycle parking dimensions..... 3-2

Figure 2-2: Bike parking in furniture zone in central business district 3-3

Figure 3-3: Bike parking on curb extension..... 3-4

Figure 3-4: Protected on street bike corral..... 3-4

Chapter 4

Figure 4-1: The sidewalk zone system, urban context..... 4-2

Figure 4-2: The curb zones transitions from the street to the sidewalk 4-2

Figure 4-3: Separated sidewalks facilitate ramp and crosswalk alignment 4-3

Figure 4-4: Separated sidewalk is free of obstructions..... 4-3

Figure 4-5: Sidewalk clearances..... 4-4

Figure 4-6: The furniture zone may be eliminated or reduced at pinch points..... 4-4

Figure 4-7: Wheel stops reduce sidewalk encroachment..... 4-4

Figure 4-8: Recommended curb side sidewalk dimensions..... 4-5

Figure 4-9: Recommended Central Business District sidewalk dimensions 4-5

Figure 4-10: Sidewalk behind ditch or swale..... 4-7

Figure 4-11: Minimum bridge sidewalk width..... 4-7

Figure 4-12: Pedestrian rail should be used when a sidewalk abuts a serious hazard 4-8

Figure 4-13: Pervious sidewalk..... 4-8

<i>Figure 4-14: Bus stop pad dimensions</i>	<i>4-10</i>
<i>Figure 4-15: Bus pullout at corner adversely impacts traffic</i>	<i>4-11</i>
<i>Figure 4-16: Bus pullout with curb extension</i>	<i>4-11</i>
<i>Figure 4-17: Curb extension bus stop</i>	<i>4-12</i>
<i>Figure 4-18: One crossing serves bus stop in both directions</i>	<i>4-12</i>
<i>Figure 4-19: Grade guideline for building access ramps and separated pathways.....</i>	<i>4-14</i>
<i>Figure 4-20: Crosswalks maintained at 2% cross slope in steep terrain.....</i>	<i>4-14</i>
<i>Figure 4-21: Furniture zone maintains sidewalk continuity</i>	<i>4-15</i>
<i>Figure 4-22: Curb tight sidewalk wraps to the back of driveway</i>	<i>4-15</i>
<i>Figure 4-23: Entire sidewalk dips at driveway, but beware the roller coaster effect</i>	<i>4-15</i>
<i>Figure 4-24: Partially lowered sidewalk at driveway.....</i>	<i>4-16</i>
<i>Figure 4-25: Minimum pedestrian access route maintained level at driveway.....</i>	<i>4-16</i>
<i>Figure 4-26: Steeper cross slopes in furniture and frontage zones keep pedestrian zone level.....</i>	<i>4-16</i>
<i>Figure 4-27: “Standard” ramp</i>	<i>4-17</i>
<i>Figure 4-28: Parallel curb ramp.....</i>	<i>4-17</i>
<i>Figure 4-29: Perpendicular ramp</i>	<i>4-18</i>
<i>Figure 4-30: Perpendicular ramp with one flare</i>	<i>4-18</i>
<i>Figure 4-31: Combination curb ramp</i>	<i>4-18</i>
<i>Figure 4-32: Ramp placement, sidewalk with furniture zone.....</i>	<i>4-19</i>
<i>Figure 4-33: Ramp placement on wide curbside sidewalk.....</i>	<i>4-19</i>
<i>Figure 4-34: Ramp placement on narrow curb tight sidewalk.....</i>	<i>4-20</i>
<i>Figure 4-35: Single ramp placement on constrained sidewalk</i>	<i>4-20</i>
<i>Figure 4-36: Blind pedestrian with clearances</i>	<i>4-20</i>
<i>Figure 4-37: Conventional driveway design</i>	<i>4-22</i>
<i>Figure 4-38: Intersection style driveway.....</i>	<i>4-23</i>
<i>Figure 4-39: Right-in, right out driveway</i>	<i>4-23</i>
<i>Figure 4-40: Alley clearly crosses a sidewalk.....</i>	<i>4-24</i>
<i>Figure 4-41: D1-3b.....</i>	<i>4-24</i>

Chapter 5

<i>Figure 5-1: All legs of all street intersections are crosswalks, regardless of the presence of sidewalks, shoulder or other “pedestrian” facility.....</i>	<i>5-2</i>
<i>Figure 5-2: Crosswalks defined for T-Intersection.....</i>	<i>5-2</i>
<i>Figure 5-3: Access management techniques such as raised medians and consolidated driveways reduce conflict points.....</i>	<i>5-5</i>
<i>Figure 5-4: Driver and pedestrian waiting for same gap are in conflict when the gap opens up.....</i>	<i>5-5</i>
<i>Figure 5-5: Intersection with all turn and crossing movements.....</i>	<i>5-5</i>
<i>Figure 5-6: Severed streets and non-traversable barrier reduce pedestrian travel options.....</i>	<i>5-6</i>
<i>Figure 5-7: Most pedestrians will cross midblock rather than walk to a signalized Intersection.....</i>	<i>5-6</i>

<i>Figure 5-8: Conflicts at intersections are many</i>	5-7
<i>Figure 5-9: Conflicts at midblock crossings may be fewer</i>	5-7
<i>Figure 5-10: Staggered continental crosswalk markings</i>	5-9
<i>Figure 5-11: Multiple threat crash occurs when Car B does not yield to pedestrian</i>	5-9
<i>Figure 5-12: An advance stop bar allows a pedestrian to see that Car B has not stopped</i>	5-10
<i>Figure 5-13: Sign R1-5c are placed adjacent to the stop bar</i>	5-10
<i>Figure 5-14: Signs W11-2 and W16-7p</i>	5-10
<i>Figure 5-15: Textured crosswalk supplemented with white lines</i>	5-11
<i>Figure 5-16: White crosswalk inset into colored pavement</i>	5-11
<i>Figure 5-17: Proper illumination makes pedestrians crossing the street more visible</i>	5-12
<i>Figure 5-18: Median allows pedestrian to cross one half of the roadway at a time</i>	5-12
<i>Figure 5-19: Midblock island with high visibility crosswalks, advanced stop lines, illumination and angles cut through</i>	5-13
<i>Figure 5-20: Crossing distance without curb extensions</i>	5-14
<i>Figure 5-21: Crossing distance with curb extensions</i>	5-14
<i>Figure 5-22: Curb extensions improve visibility of and by the pedestrian</i>	5-15
<i>Figure 5-23: Curb extension retrofit issues</i>	5-15
<i>Figure 5-24: Roadway designed with curb extensions and integrated parking lanes</i>	5-16
<i>Figure 5-25: 2-step signal: pedestrian activates signal to stop near side traffic</i>	5-17
<i>Figure 5-26: 2-step signal: pedestrian proceeds to far side crossing facing traffic</i>	5-17
<i>Figure 5-27: 2-step signal: pedestrian activates push button to stop far side traffic</i>	5-18
<i>Figure 5-28: Pedestrian overcrossing adds a lot of travel distance when raised above a roadway</i>	5-18
<i>Figure 5-29: Pedestrian overcrossing reduces travel distance when roadway is lowered</i>	5-18
<i>Figure 5-30: Undercrossing of elevated roadway</i>	5-18
<i>Figure 5-31: Raised crosswalk acts as speed hump</i>	5-19

Chapter 6

<i>Figure 6-1: Dashing bike lane prior to intersection warns motorists and bicyclists of potential conflict</i>	6-2
<i>Figure 6-2: Standard right turn lane with through bike lane</i>	6-2
<i>Figure 6-3: Right-turn lane developed by dropping parking lane</i>	6-2
<i>Figure 6-4: Right turn lane developed by dropping a lane</i>	6-3
<i>Figure 6-5: Combined right turn lane and thru bike lane</i>	6-3
<i>Figure 6-6: Right bike lane follows traffic flow</i>	6-3
<i>Figure 6-7: Bike lane at T-intersection</i>	6-4
<i>Figure 6-8: Intersection sensitive to bicycles</i>	6-5
<i>Figure 6-9: Closed crosswalk forces pedestrians to cross three streets instead of one</i>	6-6
<i>Figure 6-10: Effective vs. actual corner radius</i>	6-6
<i>Figure 6-11: Corner with no turns can have tight radius</i>	6-7

<i>Figure 6-12: Large curb radius design impacts crossing distances, crosswalk alignment and facilitates high speed motor vehicle turns</i>	<i>6-7</i>
<i>Figure 6-13: Large vehicles can be accommodated.....</i>	<i>6-7</i>
<i>Figure 6-14: Crosswalk placed at most direct route.....</i>	<i>6-8</i>
<i>Figure 6-15: Crosswalk placed at shortest crossing point.....</i>	<i>6-8</i>
<i>Figure 6-16: Crosswalk placed midway between direct and shortest routes.....</i>	<i>6-8</i>
<i>Figure 6-17: Proper pedestrian push button placement</i>	<i>6-9</i>
<i>Figure 6-18: Pedestrian refuge island and medians helps separate conflicts and assists pedestrian crossings at large intersections.....</i>	<i>6-10</i>
<i>Figure 6-19: Pedestrian refuge island at right turn slip lane</i>	<i>6-11</i>
<i>Figure 6-20: Skewed intersection increases crossing distances</i>	<i>6-13</i>
<i>Figure 6-21: Squared intersection improves visibility</i>	<i>6-14</i>
<i>Figure 6-22: Muti-legged intersection reconfigured.....</i>	<i>6-14</i>
<i>Figure 6-23: Option 1 – Drop bike lane prior to intersection.....</i>	<i>6-15</i>
<i>Figure 6-24: Option 2 – Encourages bicyclist to take thru-right lane.....</i>	<i>6-16</i>
<i>Figure 6-25: Option 3 – Preserves dedicated bike lane.....</i>	<i>6-16</i>
<i>Figure 6-26: Option 4 – Addition of pedestrian island.....</i>	<i>6-17</i>
<i>Figure 6-27: Modern roundabout</i>	<i>6-18</i>
<i>Figure 6-28: Bicyclist exit ramp detail.....</i>	<i>6-20</i>
<i>Figure 6-29: Pedestrian and bicyclist accessible urban freeway interchange with right angle approaches.....</i>	<i>6-21</i>
<i>Figure 6-30: Freeway interchange with separated pedestrian and bicyclist path to avoid high speed conflicts.....</i>	<i>6-23</i>
<i>Figure 6-31: Single Point Urban Interchange (SPUI) with pedestrian and bicyclist access.....</i>	<i>6-24</i>
<i>Figure 6-32: Bicyclist crossing at high speed entrance ramp.....</i>	<i>6-24</i>
<i>Figure 6-33: Pedestrian and bicyclist crossing at high speed exit ramp.....</i>	<i>6-25</i>
<i>Figure 6-34: Bike box.....</i>	<i>6-25</i>
<i>Figure 6-35: Raised intersection.....</i>	<i>6-26</i>

Chapter 7

<i>Figure 7-1: Shared-Use path siting considerations</i>	<i>7-3</i>
<i>Figure 7-2: Intersection and driveway conflicts at path.....</i>	<i>7-5</i>
<i>Figure 7-3: Suggested shared use path dimensions</i>	<i>7-6</i>
<i>Figure 7-4: Paved path with separate soft surface trail.....</i>	<i>7-6</i>
<i>Figure 7-5: Wide path striped to separate modes</i>	<i>7-7</i>
<i>Figure 7-6: Sample pavement designs.....</i>	<i>7-8</i>
<i>Figure 7-7: Barrier prevents roots from upheaving path.....</i>	<i>7-8</i>
<i>Figure 7-8: Railing added to concrete barrier.....</i>	<i>7-9</i>
<i>Figure 7-9: Rub rail added to railing.....</i>	<i>7-9</i>
<i>Figure 7-10: High fencing at path edges creates cattle chute effect.....</i>	<i>7-9</i>
<i>Figure 7-11: Railing needed on left, not needed on right</i>	<i>7-10</i>
<i>Figure 7-12: Offsetting path reduces need for railing</i>	<i>7-10</i>

<i>Figure 7-13: 14 feet wide bridge serves a 10 feet wide path.....</i>	<i>7-11</i>
<i>Figure 7-14: Bridge widened at view point.....</i>	<i>7-11</i>
<i>Figure 7-15: Midblock crossing with island and advance stop bar.....</i>	<i>7-12</i>
<i>Figure 7-16: Path is curved to align with crosswalk.....</i>	<i>7-12</i>
<i>Figure 7-17: Undercrossing.....</i>	<i>7-13</i>
<i>Figure 7-18: Path undercrossings, various configurations.....</i>	<i>7-14</i>
<i>Figure 7-19: Path overcrossings, various configurations.....</i>	<i>7-15</i>
<i>Figure 7-20: Path splits to prevent it appearing like a driveway.....</i>	<i>7-15</i>
<i>Figure 7-21: Tight curb radii prevent motor vehicle access.....</i>	<i>7-15</i>
<i>Figure 7-22: Offset gates prevent motor vehicle.....</i>	<i>7-16</i>
<i>Figure 7-23: Stairway with channel for bicycle tires.....</i>	<i>7-17</i>
<i>Figure 7-24: Signs R1-1.....</i>	<i>7-18</i>
<i>Figure 7-25: Signs OBR1-1 and OBR1-2.....</i>	<i>7-18</i>
<i>Figure 7-26: Appropriate use of sign OBR1-1 (or OBR1-2).....</i>	<i>7-18</i>
<i>Figure 7-27: Sign R9-6.....</i>	<i>7-18</i>
<i>Figure 7-28: Signs R5-3 and OBR10-14.....</i>	<i>7-18</i>
<i>Figure 7-29: Sign R9-5.....</i>	<i>7-19</i>
<i>Figure 7-30: Signs W1-1 and W1-2 (18"x18").....</i>	<i>7-19</i>
<i>Figure 7-31: Signs W2-1 and W2-2 (18"x18").....</i>	<i>7-19</i>
<i>Figure 7-32: Sign W7-5.....</i>	<i>7-19</i>
<i>Figure 7-33: Signs OBW12-2 and OBW12-3 (18"x18").....</i>	<i>7-19</i>
<i>Figure 7-34: Signs W10-1 and W3-1 (18"x18").....</i>	<i>7-19</i>
<i>Figure 7-35: Railroad crossing ahead markings.....</i>	<i>7-20</i>
<i>Figure 7-36: Sign W11-15 with rider W11-15P.....</i>	<i>7-20</i>
<i>Figure 7-37: Directional and street signs.....</i>	<i>7-20</i>
<i>Figure 7-38: Bicycle route sign examples.....</i>	<i>7-21</i>
<i>Figure 7-39: Beginning and end of path signing.....</i>	<i>7-22</i>
<i>Figure 7-40: Sign mounting clearances.....</i>	<i>7-23</i>
<i>Figure 7-41: Skip stripe followed by solid stripe in a curve.....</i>	<i>7-23</i>

INTRODUCTION



A complete street accommodates all travel modes, supports residences and businesses and is a community asset

The Importance of Good Design and Context

Well-designed bicycle and pedestrian facilities are safe, attractive, convenient and easy to use. It is wasteful to plan, design and build facilities that are little used, or used irresponsibly because of poor design. *Inadequate facilities discourage users and unnecessary facilities waste money and resources.*

Bicycle and pedestrian facilities must be considered at the onset of transportation projects and incorporated into the design process at all stages, so potential conflicts with other modes, topography or right-of-way constraints are resolved early on. Bikeways and walkways risk being under-designed if they are considered add-on features.

Good design does more than help those who already walk or bicycle; ODOT encourages greater use of non-motorized transportation. Examples of facilities that encourage use are:

Bike lanes provide cyclists their own space on the road. They also:

- Establish the correct position of cyclists on the road;
- Provide bicyclists room to travel at their own speed, they can pass cars backed up at intersections;
- Reduce bicycle/pedestrian conflicts as fewer cyclists ride on sidewalks; and
- Send a message to motorists that bicyclists have a right to the roadway.

Separated sidewalks create a pleasant walking environment away from traffic. They also provide:

- Room for street furniture such as signs, utility and signal poles, mailboxes and bike racks;
- An opportunity for landscaping and shade-trees, increasing the appeal of a roadway; and
- A better environment for wheelchair users, as sidewalks are level at driveways.

Context Sensitive Design

Context should always determine which type of walkway and/or bikeway to provide, and to what standard. Applying standards without regard to how a facility will function within the greater context can lead to under- or overbuilt facilities, inappropriate for the context. There are several ways of defining context; they are not mutually exclusive, and should be referred to when determining what parameters to use when providing walkways and bikeways.

1. Land uses defined in broad terms: rural, urban, suburban, and urban (or suburban) fringe. This applies in clearly defined contexts such as an urban street in an established part of a city, or a truly rural road. It is harder to define context using these terms in ambiguous situations such as a rural road in a recently annexed part of a city that is being redeveloped.

➤ Utility in selecting appropriate design criteria: Moderate

2. Land uses immediately adjacent to a street: residential, commercial, institutional, industrial, or mixed use. These can help determine what destinations may be accessible on foot or by bicycle by those using that street.

➤ Utility in selecting appropriate design criteria: Moderate/High

3. The 1999 Oregon Highway Plan has identified four types of urban highway segment designations:

- Special Transportation Areas (STA),
- Urban Business Areas (UBA),
- Commercial Centers, and
- Non-Designated Urban Highways.

The Oregon Highway Design Manual also describes categories that do not meet the requirements or intent of the other highway segment designations:

- Urban Fringe/Suburban,
- Developed, and
- Traditional Downtowns/Central Business Districts.

Definitions, applicability and policies regarding these designations can be found in the Oregon Highway Plan: www.oregon.gov/ODOT/TD/TP/orhwyplan.shtml#1999_Oregon_Highway_Plan and the Oregon Highway Design Manual: www.oregon.gov/ODOT/HWY/ENGSERVICES/hwy_manuals.shtml#2003_English_Manual

➤ Utility in selecting appropriate design criteria: Moderate/High

4. “Main Street: When a Highway Runs Through it”: published by the Oregon Downtown Development Association (in cooperation with ODOT), it is designed for communities that are working together to enhance the vitality of their main street (<http://www.odda.org/content/pubs.html>).

➤ Utility in selecting appropriate design criteria: High

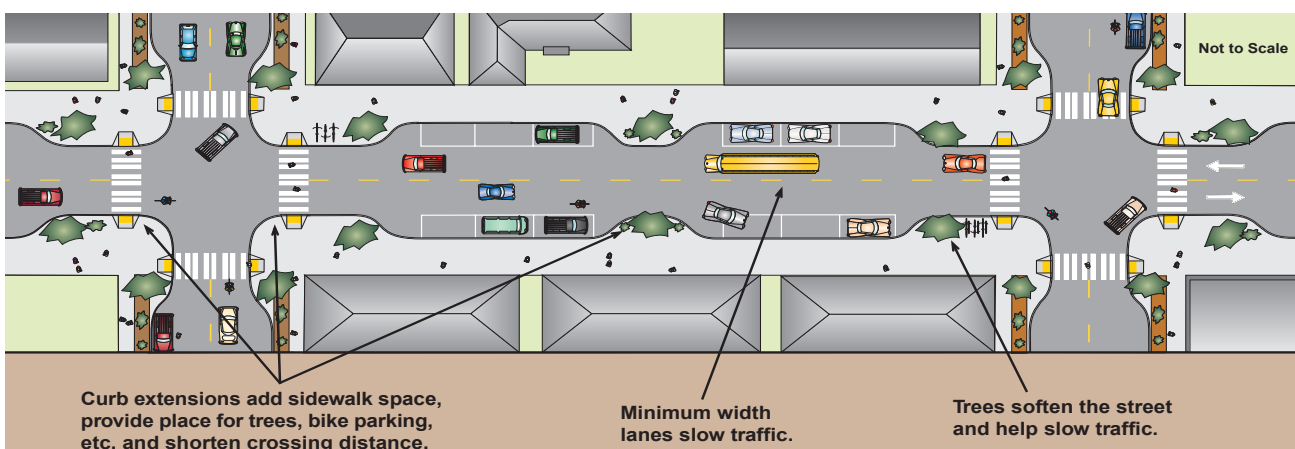

Figure I-1: Sample illustration from Main Street Handbook

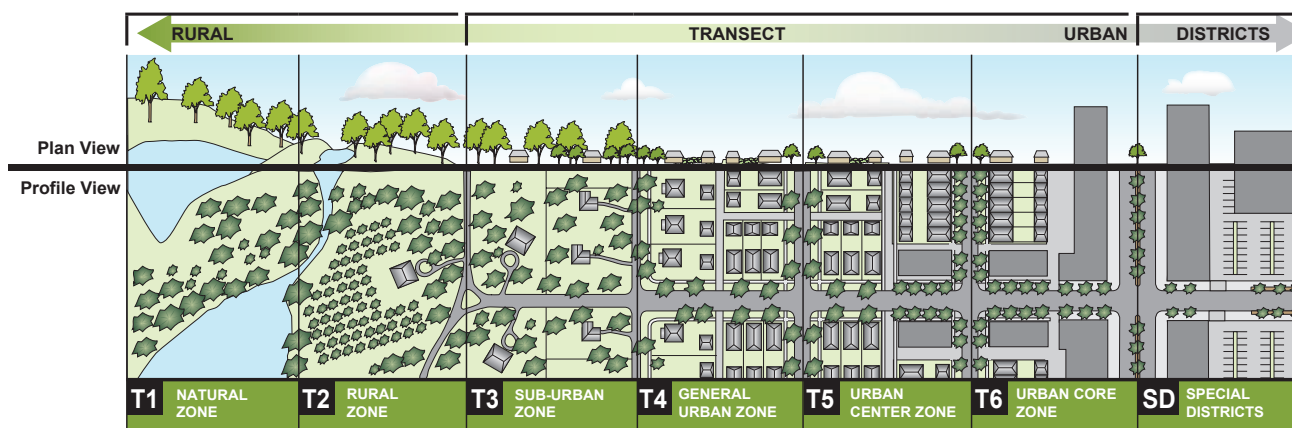

Figure I-2: The Transect (Congress of New Urbanism)

5. The Transect, a context classification created by the Congress for New Urbanism, a framework that identifies a continuous range of habitats from the most natural to the most urban; the 6 Transect Zones are:

- T-1 Natural Zone: lands approximating a wilderness condition, unsuited for settlement due to topography, hydrology or vegetation.
- T-2 Rural Zone: sparsely settled lands in open or cultivated state; woodland, agricultural, etc.
- T-3 Sub-Urban Zone: low-density suburban residential areas with deep setbacks, natural planting, long blocks and irregular roads to accommodate natural conditions.
- T-4 General Urban Zone: mixed-use but mostly residential urban with a range of building types with variable setbacks, and medium-sized blocks.
- T-5 Urban Center Zone: high density mixed-use buildings with retail, offices, rowhouses and apartments, a tight network of streets, wide sidewalks, street trees and buildings set close to the frontages.
- T-6 Urban Core Zone: the highest density, with the greatest variety of uses, and civic buildings of regional importance.
- Special Districts: areas with buildings that by their function, disposition, or configuration cannot conform to one of the Transect Zones.

➤ Utility in selecting appropriate design criteria: Very High

6. Portland Metro's regional street design concepts reflect the fact that streets perform many, often conflicting functions, and the need to reconcile conflicts among travel modes to make the transportation system safer for all modes of travel. Implementation of the design concepts is intended to promote community livability by balancing all modes of travel and address the function and character of surrounding land uses when designing streets of regional significance. The street design concepts fall into three broad classifications:

- Throughways emphasize motor vehicle and freight travel and connect major activity centers and provide inter-city, inter-regional and inter-state connections, with an emphasis on mobility.
- Boulevards in mixed-use areas (e.g. 2040 centers, station communities and main streets) integrate motor vehicles, freight, transit, bicycle and pedestrian modes of travel, with an emphasis on pedestrian, bicycle and transit travel.
- Streets in 2040 mixed-use corridors, industrial areas, employment areas and neighborhoods integrate motor vehicles, freight, transit, bicycle and pedestrian modes of travel, with an emphasis on vehicle mobility and special pedestrian infrastructure on transit streets.

- Utility in selecting appropriate design criteria: High

7. AASHTO Street (functional) Classification System:

For the purposes of highway and street design, the American Association of State Highway and Transportation Officials (AASHTO) developed the functional classification system (or street hierarchy) to determine which design standards are applicable; the classifications are **arterial, collector and local streets**. Local streets serve residences and short neighborhood trips; collectors gather traffic from the neighborhoods and channel vehicles onto arterials, which are designed for longer trips. Most commerce, institutions and other important destinations are located on arterials.

The street hierarchy is a planning tool for motor vehicle traffic, and is the basis for many of the design criteria in AASHTO. It is not always a practical design tool, as arterial, collector and local streets are found in a variety of land use contexts. The practice of standardizing typical sections for each of these classifications results in many streets that do not serve bicyclists, pedestrians or adjacent properties well. To effectively design for bicyclists and pedestrians, the context of the street must be considered; each context requires different design treatments - one size does not fit all.

The design should match the context, not the street classification.

Also, pedestrians and bicyclists have their own needs; they may want to travel to major destinations using local streets, or conditions on arterials may be very intimidating to them (high traffic volumes and speeds, no sidewalks or bike lanes, buildings set far back and difficult to access on foot).

This manual proposes a more comprehensive approach, one more compatible with the needs of pedestrians and bicyclists. Terms such as thoroughfares and residential streets capture the essence of the function and the

look and feel of a street from their perceptive. The Oregon Highway Plan (OHP) should be consulted for highway classification as it applies to vehicular traffic.

- Utility in selecting appropriate design criteria: Low

Regardless of which context or street classification system is used, land uses change over time, in most cases towards a denser, more urban form. Street projects are usually designed for a 20-year life (bridges 50 years or more), so planners and designers must consider how a planned roadway will function in the future. It is better to build facilities that may not be immediately needed, rather than come back later and retrofit them at great expense. But over design (a road widened to accommodate future traffic volumes but is too wide for the current conditions) may encourage speeding. To avoid this outcome, measures should be taken in the interim to slow traffic down, such as delineating the widened pavement with markings, so the roadway appears narrower.

Bicyclists and Pedestrians: Similarities & Differences

Many early bikeway designs assumed that bicyclists resemble pedestrians in their behavior. This led to undesirable situations: bicyclists are under-served by inadequate facilities, pedestrians resent bicyclists in their space, and motorists are confused by bicyclists entering and leaving the traffic stream in unpredictable ways. Only under special circumstances should bicyclists and pedestrians share the same space, e.g. on shared-use paths. The modes are similar in several ways:

Location: Bicycle and pedestrian facilities, though separate from each other, are found between the motor vehicle travel lanes and the right-of-way line, often in conflict with other demands such as utilities. This can create competition for this valuable space.



Context Sensitive Designs: Both streets serve all modes - Bicyclist on the left shares the road with traffic in an urban slow speed environment. Pedestrian on the right uses the shoulder in a rural context

Exposure: Pedestrians and bicyclists are exposed to the elements and are vulnerable in crashes.

Behavior: Pedestrians and bicyclists can be of any age and no license is required. Their actions and reactions change with age and are sometimes unpredictable.

Bicyclists and pedestrians differ in significant ways:

Bicyclists

Bicyclists operate a vehicle and are legitimate road users, but they are slower and less visible than motor vehicles; they are also more vulnerable in a crash than motorists. They need accommodation on busy, high-speed roads and at complex intersections. In congested urban areas, bicyclists can often proceed faster than motorists on well-designed facilities.

Bicyclists use their own power, must constantly maintain their balance and don't like to interrupt their momentum. They like to ride side-by-side so they can interact socially with a riding companion. Typical bicyclist speeds range from 10-15 MPH, enabling them to make trips up to 5 miles or so in urban areas in about 25 minutes; this is equivalent to a typical suburban commuter trip time.

Well-designed bicycle facilities guide cyclists to ride in a manner that conforms to the vehicle code: in the same direction as traffic, usually in a position 3 to 4 feet from the edge of the roadway or parked cars, to avoid debris, drainage grates and other potential hazards. Cyclists should be able to proceed through intersections in a direct, predictable and safe manner.

Pedestrians

Pedestrians prefer separation from traffic and are slower than bicyclists. They need extra time for crossing roadways, special consideration at intersections and traffic signals, and other improvements to enhance the walking environment. Some design details contribute to safety (illumination), some make walking more convenient (paths that provide short-cuts), and others make walking more pleasant (planting strips).

Pedestrians are the most vulnerable of road users and are often not visible to motorists. They don't tolerate delay and out-of-direction travel, and will often take shortcuts where there is no convenient or direct access. Pedestrian facilities must be designed to meet or exceed the ADA requirements (Americans with Disabilities Act).

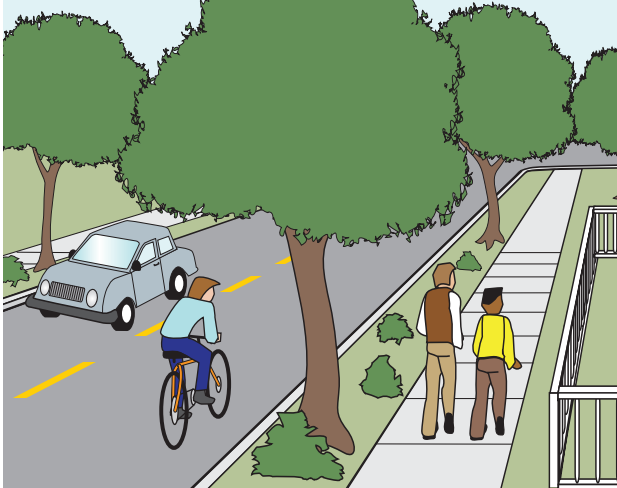

Figure I-3: Streets can be made pleasant for all users

On well-planned and well-designed streets (with buildings that abut the sidewalk), sidewalks provide mobility and also serve as direct access to destinations. Pedestrians simply walk on a sidewalk, enter a building, leave it and continue on their way, with no need for parking, a driveway or specially designed access. This underscores the importance of good urban design in creating walkable environments.

Typical walking speeds range from 2-3.5 MPH, enabling them to make trips up to a mile or so in urban areas in about 20 minutes; this is equivalent to a typical urban trip for errands.

Design Standards

The design standards and recommendations in this document are for use on Oregon highways. The previous discussion on context sensitive design should be consulted when determining which standard is applicable for the context.

ODOT encourages local agencies to use the dimensions and designs recommended in this plan; local standards may exceed ODOT standards. When ODOT is constructing a bikeway or walkway in collaboration with a local jurisdiction, the more appropriate of the two designs should be used, based on the context. On some local streets, dimensions less

than those recommended in this plan may also be appropriate; for example non state highways can have very narrow motor vehicle travel lanes to accommodate bike lanes.

To establish primary design practices, ODOT has adopted the American Association of State Highway and Transportation Officials (AASHTO) guidelines. AASHTO publishes the “Guide for the Development of Bicycle Facilities,” and the “Guide for the Planning, Design and Operation of Pedestrian Facilities.” Most ODOT design standards are contained in the “Highway Design Manual” (HDM).

Relationship between this document, AASHTO

and the HDM: This plan contains some recommendations and best practices that exceed AASHTO and/or the HDM standards. Also included in this plan are designs that ODOT has developed for situations that are not covered by AASHTO or the HDM. On state highways, the standards in the HDM must be met as a minimum; on local agency projects where funds are administered through ODOT, the AASHTO standards must be met as a minimum; on local agency projects using local funds, local agencies can adopt AASHTO or the practices recommended in this manual.

Relationship between this document and ADA:

All ODOT walkway design standards meet or exceed the minimums set by the Americans with Disabilities Act Accessibility Guidelines (ADAAG) and the proposed Public Right-of-Way Accessibility Guidelines (PROWAG).

Relationship between this document and

the MUTCD: Traffic control devices must conform to the “Manual on Uniform Traffic Control Devices” (MUTCD) as supplemented and adopted by the Oregon Transportation Commission. Oregon has developed signing and striping standards for ODOT highways; these are also recommended practices for all Oregon roads. They are contained in the ODOT Traffic Line Manual, the ODOT Sign Policy, and ODOT standard drawings. All

signing and striping plans should be reviewed by a traffic engineer.

Relationship between this document, local plans and Transportation System Plans:

Designers should consult adopted local TSP's to ensure designs are consistent with local adopted and acknowledged plans and standards; otherwise a local plan amendment is needed.

Note: Some dimensions referenced in this document (for example travel lane width in relation to bike lane restriping in chapter 2) are for illustration purposes only, and should not be used as roadway design standards.

Standards & Minimums

The standards recommended in this manual are best practices; they have been developed to create optimal conditions for most users under most conditions. Whenever possible and appropriate, facilities should be built to standard.

There are situations where standards cannot be met due to geometric or environmental constraints, or may not be appropriate, due to the context. In these circumstances, a reduced dimension may be acceptable; for every standard dimension a minimum is provided. Use of a minimum dimension should be mitigated with other design controls. However, dimensions should not be reduced to the extent that safety and usability are compromised. ODOT and many local agencies have developed processes to be followed when standards can't be met (usually a design exception or concurrence process).

There is always a range between the standard and the minimum, so intermediate values may be used. For example, the standard width for a sidewalk is 6 feet, with a minimum of 5 feet; sidewalks may also be 5.5 feet wide, depending on circumstances. In some circumstances dimensions greater than the standard are appropriate, such as on high-use sidewalks or shared-use paths.

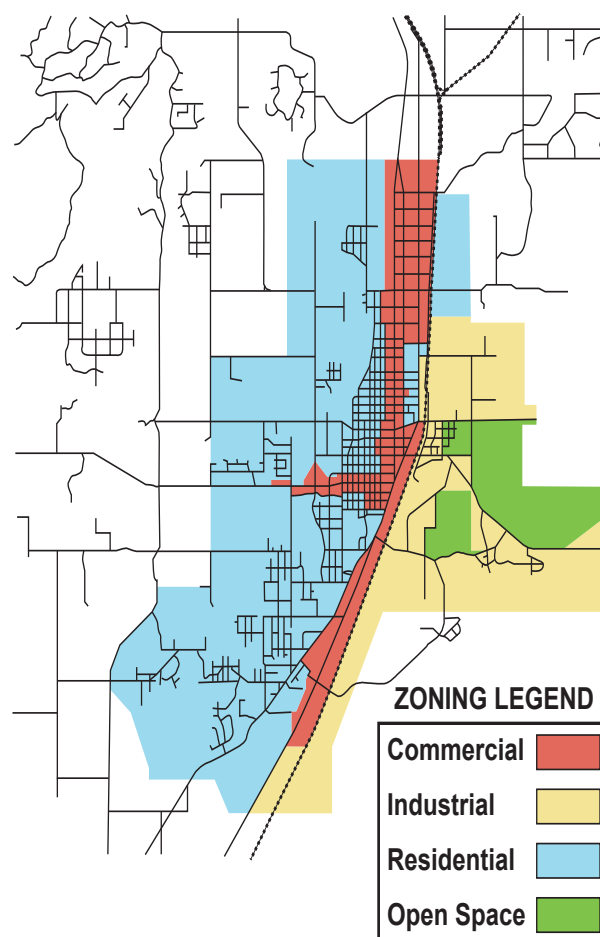

Figure I-4: Segregated land uses increase travel distances

Innovative Designs

There are many innovative designs that facilitate bicycling and walking that are not yet found in existing design manuals. This plan presents ideas that have been implemented successfully in Oregon or elsewhere, to enhance the roadway environment for bicyclists and pedestrians, or to lessen the negative impacts of designs created to improve motor-vehicle flow. These practices are preceded with the following paragraph:

“These concepts are presented as information, to help ODOT, cities and counties to come up with new solutions to common problems.”

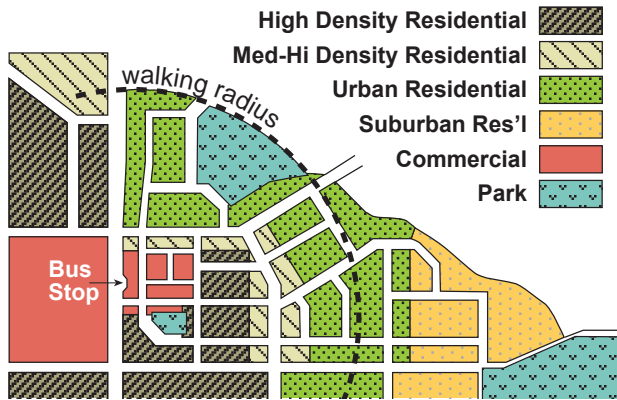

Figure I-5: Mixed land use fosters walking and bicycling

Planning Issues that impact walkway and bikeway design:

Land Use and Site Design

The ease of bicycling and walking is often determined by land use patterns. Most development patterns built since World War 2 create situations where an automobile is required for most trips, because:

- Segregated land uses increase the distance between origin and destination points;
- Destinations are designed to be readily accessible by automobile with buildings set far back, separated from the roadway with parking; and
- The resulting high traffic volumes and speeds on many streets discourage bicycling and walking.



Fast food with direct pedestrian access

Land use and site design patterns conducive to bicycling and walking include:

- **Greater densities**, so more residents live closer to neighborhood destinations such as stores, employment and schools;
- **Mixed-use zoning**, so destinations are closer to residential areas, making it easier to access these facilities on foot or by bicycle;
- **Multiple-use zoning**, where residences and businesses share the same structure, further reducing travel demand;
- **Locating buildings close to the street**, (ideally at the back of sidewalk) for easy access by pedestrians, and to create a sense of enclosure and comfort; and
- **A pleasant environment**, with landscaping, streetscaping and interesting building facades.

Integrating land-use and transportation planning enables new developments to implement these strategies from the onset. Communities planned to support balanced transportation make walking, bicycling and public transit attractive options.

In established communities, many of these goals can be met with in-fill development to increase density, changing zoning laws to allow mixed-use development, changing building codes and site-designs to be more accessible on foot or by bicycle, and building bicycle and pedestrian connections into and through existing, auto-oriented land uses.

Interconnected Streets

Street patterns with cul-de-sac require a long circuitous route to cover what could be a short distance, increasing out-of-direction travel for what would otherwise be a fairly short bicycle or walking trip. Disconnected streets also result in many short driving trips being made on thoroughfares adjacent to neighborhoods, unnecessarily increasing traffic volumes on these streets, and further degrading conditions for walking and biking.

Interconnected streets offer direct routes with minimal out-of-direction travel; they also allow local trips to be made using a variety of routes, lessening the burden on adjacent thoroughfares. This creates an inherently walkable and bikeable street system.

Discontinuous streets should be linked with through streets or paths. Where the right-of-way is insufficient for a street, or where cul-de-sac are incorporated into a development, paths can be provided for bicycle and pedestrian access.

Retrofitting path connections between neighborhoods can be difficult if adjacent property owners object. Often connections become available when a street is abandoned. A 20 feet easement or right-of way can be established before the street right-of-way is vacated.

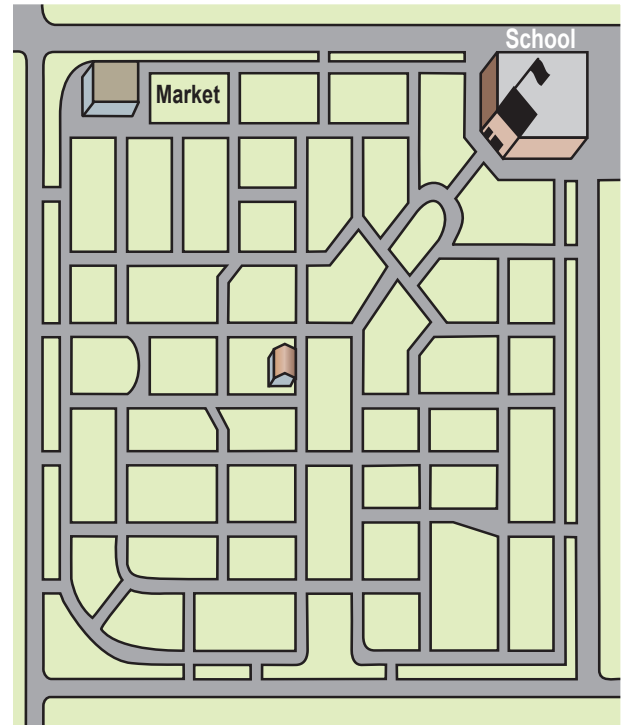

Figure I-7: Connected streets reduce travel distances, reduce traffic and increase mode choices

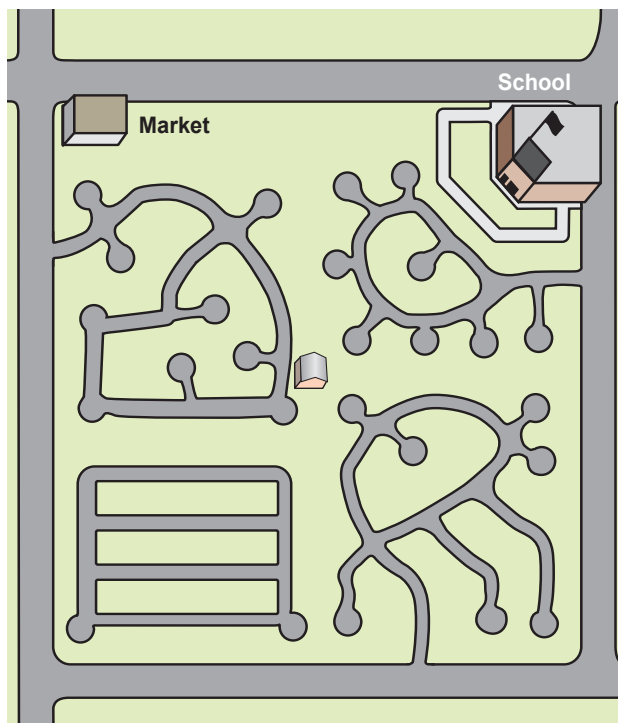

Figure I-6: Disconnected streets increase travel distances

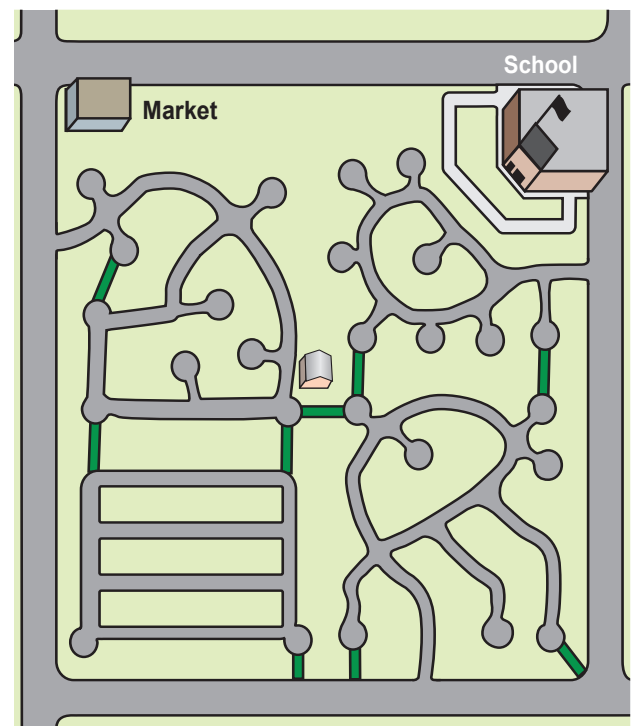

Figure I-8: Discontinuous streets linked with paths

Access Management (AM)



Unlimited accesses increase conflict points

Problems with Uncontrolled Access

Busy urban thoroughfares are often perceived as undesirable for non-motorized travel because of high motor vehicle traffic volumes. Yet conflicts rarely occur with users traveling in the same direction; most conflicts occur at

intersections, driveways and alleys. Multiple accesses create conflicts between motor vehicles entering or leaving a roadway and bicyclists and pedestrians riding or walking along the roadway. Pedestrians crossing a roadway require gaps in traffic, but with unlimited access, vehicles entering the roadway quickly fill available gaps. Bicyclists and pedestrians are vulnerable if motorists fail to see or yield to them.

Benefits of AM to Bicyclists & Pedestrians

The three basic access management techniques (limiting and consolidating driveways, providing raised medians, creating frontage roads) can benefit bicyclists and pedestrians in several ways:

- The number of conflict points is reduced; this is best achieved by replacing a center-turn lane with a raised median, as left turns

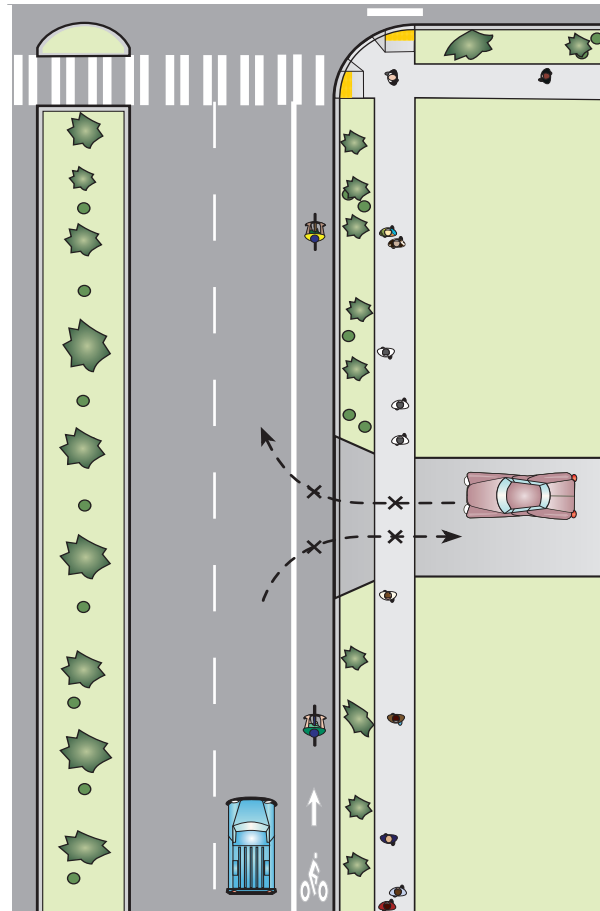
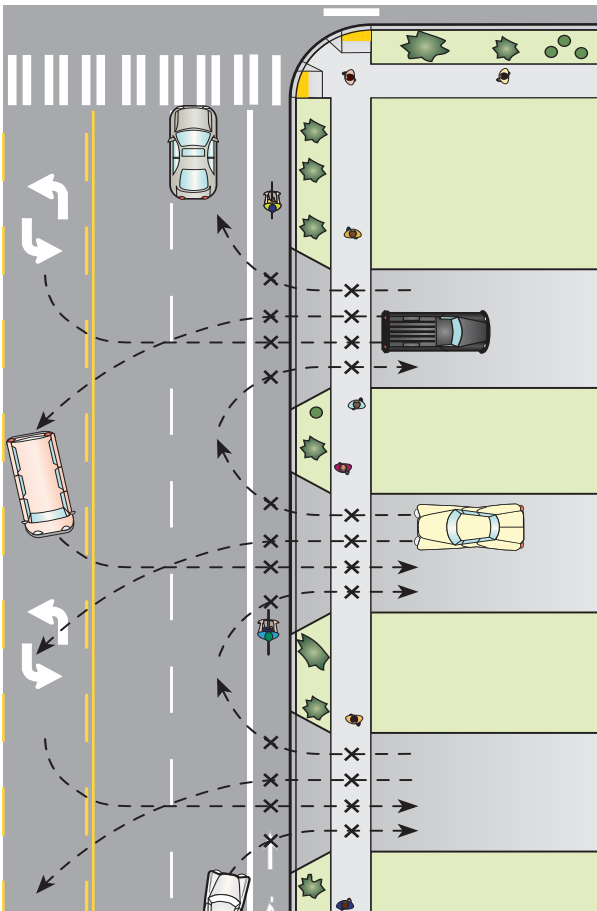

Figure I-9: Consolidating accesses reduces conflict points, benefitting pedestrians, bicyclists and drivers.

account for a high number of crashes for all users (drivers, bicyclists and pedestrians);

- Motor vehicles are redirected to intersections with appropriate control devices;
- Pedestrian crossing opportunities are enhanced with a raised median and fewer conflicts with turning cars;
- ADA compliance is easier, as the need for special treatments at every driveway is reduced; and
- Improved traffic flow may reduce the need for road-widening, allowing part of the right-of-way to be recaptured for bicyclists, pedestrians and other users.

While new roads can be designed using these principles, it is more difficult to retroactively reduce, consolidate or eliminate existing accesses. Yet this is an important strategy to make existing roads more attractive to bicyclists and pedestrians.

AM Outcomes That Hinder Walking and Bicycling

The following issues must be considered and addressed when implementing access management:

- Streamlining a thoroughfare may increase traffic speeds and volumes;
- Reduced access to businesses may require out-of-direction travel, discouraging walking and bicycling; and
- Improperly designed raised medians act as barriers: pedestrians should be able to see to the other side of the street (vegetation should not decrease visibility) and curbs should be no more than standard height. Concrete barriers and tubular markers, for example, completely prohibit crossings.

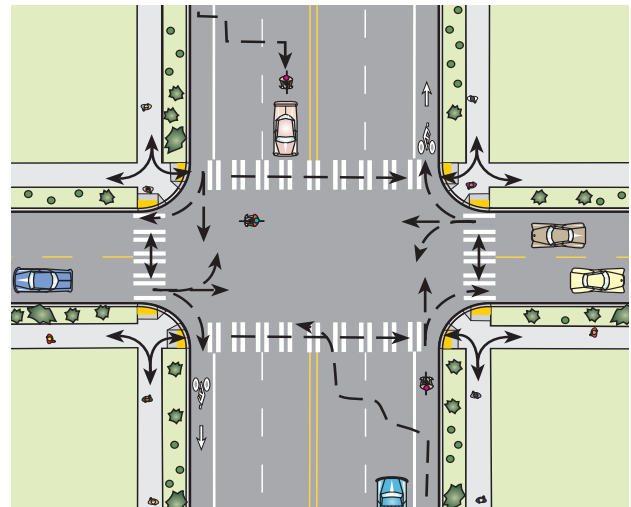

Figure I-10: Allowable movements at an intersection

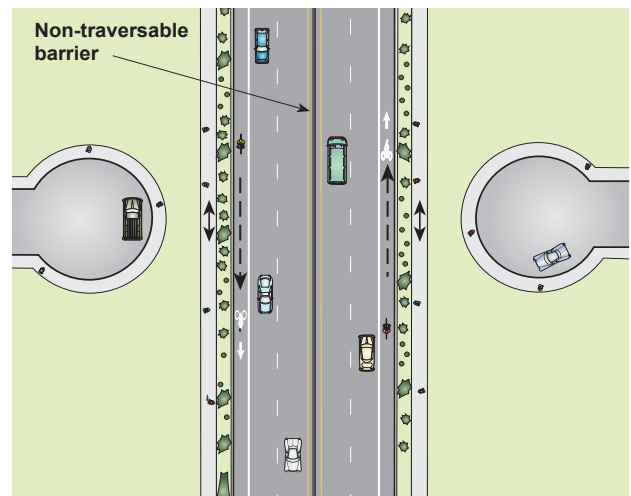

Figure I-11: Severed connection eliminates conflicts.

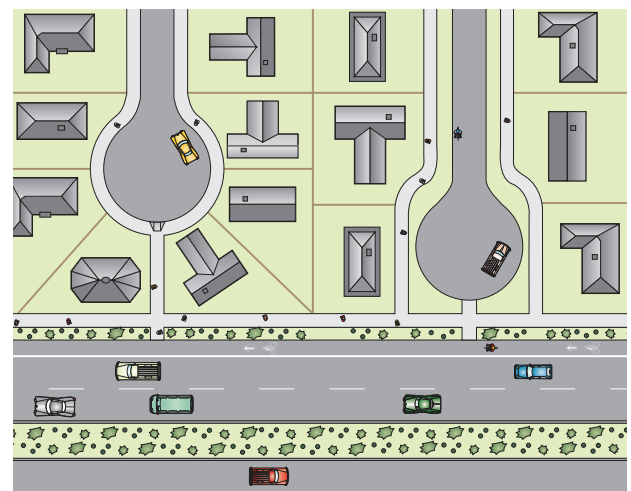

Figure I-12: Pedestrian and bicycle connections can be preserved

AM and Street Connectivity

Limiting the number of street connections has a negative impact on walking and bicycling, as eliminating local street intersections eliminates pedestrian crossing opportunities, reduces pedestrian and bicycle travel choices, and increases out-of-direction travel. Wherever possible connections should be reestablished with pathways.

Where limited access thoroughfares exist in urban areas, safe and frequent grade-separated crossings should be provided, and parallel local streets should be improved for bicycle and pedestrian circulation.

Public Transit

Transit trips begin and end with a walk or bike ride. Pedestrian and bicycle facilities in transit corridors make transit systems more effective. Therefore, high priority should be given to providing sidewalks and bikeways on transit routes and on local streets feeding these routes.

Transit users need to cross the road safely at stops: on a street with residences and/or development on both sides, half the riders will need to cross a road when boarding or exiting a bus. Since there is an element of risk in crossing busy streets, crossing safety should be a primary consideration at transit stops. The safety of pedestrians can also be enhanced by consolidating, relocating or eliminating stops. These transit operation improvements are usually implemented by the transit agency in cooperation with the road authority.

Access to transit also involves selecting the right location for stops, especially for bus stops located on surface streets. Choosing transit stop locations for buses, light rail and Bus Rapid Transit is a complicated task, as each location must take into account three factors:

- **Passengers:** stops must be near places where there's an expectation of riders;

- **Access:** if a stop can't be located right where riders are, they must be able to get to the stop conveniently; and
- **Traffic characteristics:** buses can't always stop where riders want to be because of complex traffic patterns, especially at intersections.

Convenient access by passengers must remain at the forefront of all transit stop planning: simply eliminating stops because they are perceived as unsafe will not be satisfactory to riders who cannot walk very far. Better approaches are to make access and crossing improvements at existing stops that serve passengers well, or to relocate them to a safer and more accessible location within a reasonable walk.

Bus stops should provide a pleasant environment for waiting passengers, with shelters, landscaping, adequate buffering from the road and lighting. Bus stop design should minimize conflicts with other non-motorized users, such as bicyclists on bike lanes or pedestrians walking past passengers waiting to board.

Bus stops should be placed in locations that are readily accessible by pedestrians, or that can be made accessible by changing the configuration of adjacent land use. This can be done by:

- Orienting building entrances to the transit stop or station;
- Clustering buildings around transit stops; and
- Locating businesses close to transit stops.

Regional and statewide public transportation systems benefit from bicycle facilities such as:

- Accommodating bicycles on buses and trains;
- Bikeways leading to stations, transit centers and park-and-ride lots; and
- Providing secure bicycle parking at these locations.



Well planned and situated bus stop

CHAPTER 1: ON-ROAD BIKEWAYS



A high volume urban street with bike lanes.

Types of Bikeways

Bicycles are legally classified as vehicles and are ridden on most public roads in Oregon, which are open to bicycle traffic with a few exceptions (mostly the freeways in the metropolitan area of Portland).

Roadways must be designed to allow bicyclists to ride in a manner consistent with the vehicle code.

A bikeway exists on any road that has the appropriate design treatment to accommodate bicyclists, based on motor vehicle traffic volumes and speed. The basic design treatments used for bicycle travel on roads are shared roadway, shoulder bikeway, or bike lane. A shared-use path is a facility separated from the roadway.

Bikeway types (listed with no implied order of preference):

Shared Roadway: Bicyclists and motorists ride in the same travel lanes. There are no specific dimensions for shared roadways. They are

usually narrow, so a motorist has to cross over into the adjacent travel lane to pass a cyclist. Shared roadways are common on neighborhood residential streets, on rural roads and low-volume highways.

Bicycle Boulevards: The operation of a local street is modified to function as a through street for bicyclists while maintaining local access for automobiles. Traffic calming devices control traffic speeds and discourage through trips by automobiles. Traffic controls limit conflicts between automobiles and bicyclists and give priority to through bicycle movement.

Shoulder Bikeway: A shoulder bikeway is a paved shoulder that provides a suitable area for bicycling, reducing conflicts with faster moving motor vehicle traffic. Most bicycle travel on the rural state highway system, and on many county roads, is accommodated on shoulder bikeways.

Bike Lane: A portion of the roadway designated for preferential use by bicyclists. Bike lanes are appropriate on busy urban thoroughfares. They may be used on other streets where bicycle travel and demand is

substantial. Bike lanes are marked to call attention to their preferential use by bicyclists.

Shared-Use Path (formerly called bike path or multi-use path): A facility separated from motor vehicle traffic by an open space or barrier, either within the roadway right-of-way or within an independent right-of-way. These are typically used by pedestrians, joggers, skaters and bicyclists. Shared-use paths are appropriate in corridors not well served by the street system, to create short cuts that link origin and destination points and as elements of a community trail plan. See *Chapter 7* for design standards.

Urban/Suburban Bike Facility Separation Matrix

What level of separation is needed in urban/suburban settings?

(Refer to Table 1-2 for shoulder recommendations on rural roadways)

The need for bike facility separation from traffic increases as motor vehicle traffic volumes increase. The chart page 1-3 can be used to determine when what level of separation is needed. When speed and volume intersect in a gray area, use Table 1-1 to guide decision-making: assess as many of the indicators in the matrix as possible. If they overwhelmingly point to an increased or decreased need for separation, the decision is made easier. In situations that are not clear-cut, many other factors should be considered and weighed, along with good judgment. Neither the chart nor the matrix should be used as absolutes.

**Note: Cycle tracks are appropriate in some urban and suburban contexts, but they are not yet widely used in Oregon. Over the life of this document it is expected that planning, design and implementation information will grow and that more cycle tracks will be built. Thus they are included in this guidance.*

Urban/Suburban Recommended Separation Matrix

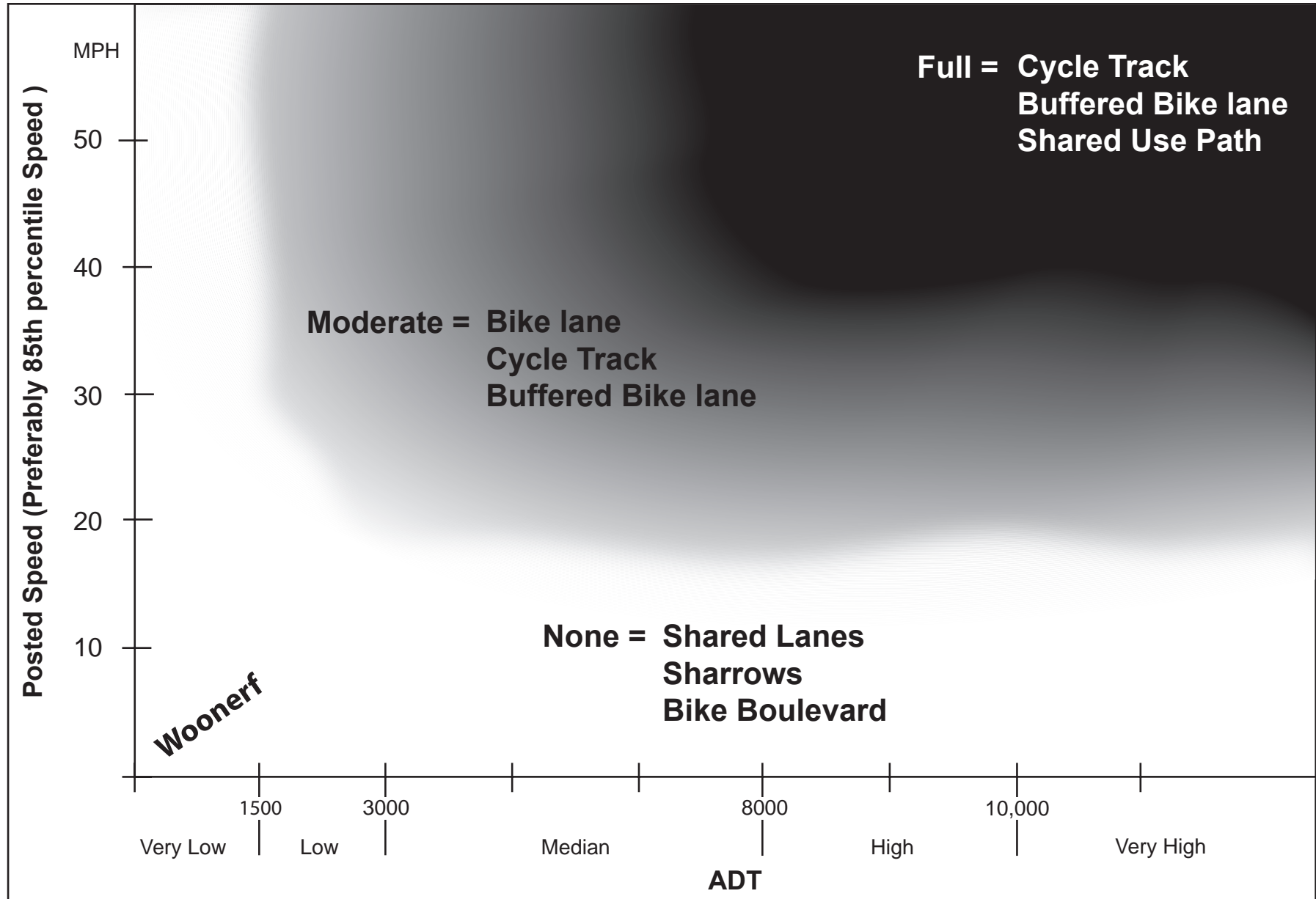

Context	Need for Separation
1. Land Use indicators	
Urban Center, CBD	Decreases
Suburban	Increases
Buildings at back of sidewalk	Decreases
Buildings set back from roadway (parking lots front street)	Increases
On Street Parking	Decreases
Short block length	Decreases
Long block length	Increases
2. Traffic speed/volume indicators	
Signal coordination timed at higher than posted speeds	Increases
Signal coordination timed at lower than posted speeds	Decreases
Peak Hourly Traffic Volume greater than 10%	Increases
3. Roadway characteristics	
Wide roadway / multiple travel lanes	Increases
Steep grades: uphill	Increases
Steep grades: downhill	Decreases
4. Bicycling demand indicators	
Popular Route to School	Increases
Provides continuity of bike lanes, routing or trail	Increases
Other high-use indicators	Increases

Table 1-1: Separation Context matrix

Discussion

Land Use influences traffic patterns and the comfort and confidence of bicyclists. Urban centers, with narrower travel lanes, buildings at the back of walk and on-street parking give cues to motorists to pay more attention to their environment and to slow down. Wide suburban streets with few potential risks to drivers increase motor vehicle speeds and decrease driver vigilance.

Buildings Setbacks determine a human scale streetscape. Buildings at the back of walk reduce motor vehicle speeds and provide direct access to destinations; under these conditions, bike lanes are less needed. Buildings set back from the roadway, with parking in front, create conditions (lowered driver vigilance, speeding) whereby bike lanes should be provided.

On-Street Parking benefits bicyclists and pedestrians by reducing motor vehicle speeds.

The benefit is lower if on-street parking is under utilized, due to ample off-street parking.

- Note: building setbacks and on-street parking interrelate: buildings at the back of walk and on-street parking go hand-in-hand.

Block Length Urban centers have shorter blocks and suburban areas have longer blocks. Bike lanes are more necessary where blocks are long, as riders need to travel further on the thoroughfare to access destinations.

Prevailing Speed is related to posted speed, but drivers will drive faster if the roadway cues allow them to. Speed studies are often not practical for planning purposes; therefore the chart relies on posted speed. However, if the travel speed is known to be higher or lower than the posted speed, that information should be used to determine if bike lanes are needed.

Signal Coordination Signals timed at 25 MPH or less allow bicyclists to share the travel lane with motor vehicles; signals timed at greater than 30 MPH make sharing more difficult.

Peak Hourly Traffic Volume If a roadway with moderate traffic volumes experiences an intense peak for a sustained period of time, bike lanes are needed to provide room during this period.

Roadway Width/ Number of Travel Lanes influence the behavior of drivers and the comfort and confidence of bicyclists. Wide travel lanes and multi-lane roads increase the likelihood of speeding by drivers, decreasing the desirability of lane sharing by bicyclists.

Steep Grade Bicyclists travel uphill slowly and tend to meander. If constraints allow only one bike lane, it should be placed in the uphill direction.

Bicycle Demand is always a good reason to provide bike lanes, but lack of adequate bicycling facilities may mask a potential demand. School route, parks or community centers are reasons to favor providing a bike lane. Route continuity can be used to justify short segments of bike lanes that connect other bike lanes or a discontinuous trail.

Trade-offs: do you force bike lanes or change the context?

If the matrix indicates a need for bike lanes and there is simply no room for bike lanes, or the trade-offs are too burdensome, one option is to change the context so a shared roadway is more acceptable. For example, when there is a trade off between on-street parking and bike lanes, bike lanes can be eliminated if motor vehicle speeds can be reduced to less than 25 MPH, and if on-street parking is sufficiently utilized. For long segments (10 blocks or more) where constraints don't allow for bike lanes, another option is to provide a parallel route; the alternate route should be improved to favor bicycle travel (e.g. a bike boulevard).

Design Standards

Shared Roadways

Shared roadways are the most common bikeway type. There are no specific bicycle standards for most shared roadways. Most are fairly narrow; they are simply the roads as constructed.

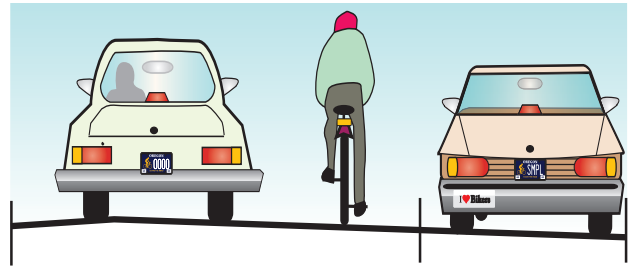

Figure 1-1: Shared roadway

Shared roadways are suitable in urban areas on streets with low motor vehicle speeds or traffic volumes, and on low-volume rural roads and highways. The suitability of a shared roadway decreases as motor vehicle traffic speeds and volumes increase, especially on rural roads with poor sight distance. See Bike Lane Matrix for suitability of shared roadways based on motor vehicle speeds, volumes and context.



Low volume residential shared roadway

On rural roads with high bicycle use or demand, roads should include shoulders where motor vehicle speeds and volumes are high.



Street too busy for shared roadway

Many urban local streets carry excessive traffic volumes at speeds higher than they were designed to carry. These can function better as shared roadways if traffic speeds and volumes are reduced. There are many traffic-calming techniques that can make these streets more amenable to bicycling on the road.

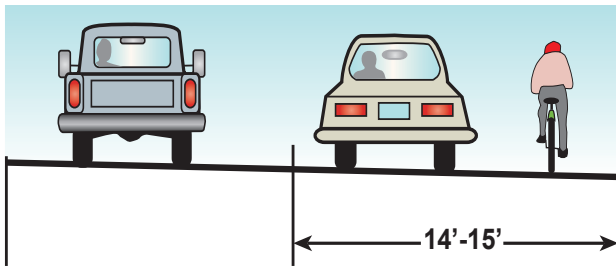

Figure 1-2: Wide curb lane

On major streets where a bike lane would be more appropriate, but with insufficient width for bike lanes, wide curb lanes may be provided. This may occur on retrofit projects where there are physical constraints, and all other options have been pursued, such as removing parking or narrowing travel lanes. Wide curb lanes are not particularly attractive to most cyclists; they simply allow a passenger vehicle to pass cyclists within a travel lane, if cyclists are riding far enough to the right. Wide curb lanes may also encourage higher motor vehicle speeds, which is contrary to the expressed desires of many residents; wide lanes should never be used on local residential streets. A wide lane should be 14 to 15 feet wide to allow a passenger car to pass a cyclist in the same lane. Widths 16 feet or

greater encourage the undesirable operation of two motor vehicles in one lane. In this situation, a bike lane should be striped.

Bicycle Boulevards

The bicycle boulevard is a refinement of the shared roadway concept; the operation of a local street is modified to function as a through street for bicyclists while maintaining local access for automobiles:

- Traffic-calming devices reduce motor vehicle speeds and through trips; and
- Traffic controls limit conflicts between motorists and bicyclists and give priority to through bicyclist movement.

Advantages of Bicycle Boulevards

1. Opportunity: traditional street grids offer local streets that can be converted to bicycle boulevards;
2. Bicycle travel on local streets is compatible with local land uses;
3. Bicycle boulevards may attract cyclists who do not feel comfortable on busy streets and prefer to ride on lower traffic streets;
4. Traffic calming techniques are favored by residents who want slower traffic on neighborhood streets; and
5. Bicycle boulevards can improve conditions for pedestrians, with reduced traffic and improved crossings.

Successful bicycle boulevard implementation requires careful planning with residents and businesses to ensure acceptance.

Elements of a Bicycle Boulevard

A successful bike boulevard project requires:

1. Selecting a direct and continuous street, rather than a circuitous route that winds through neighborhoods. Bike boulevards work best on a street grid system;

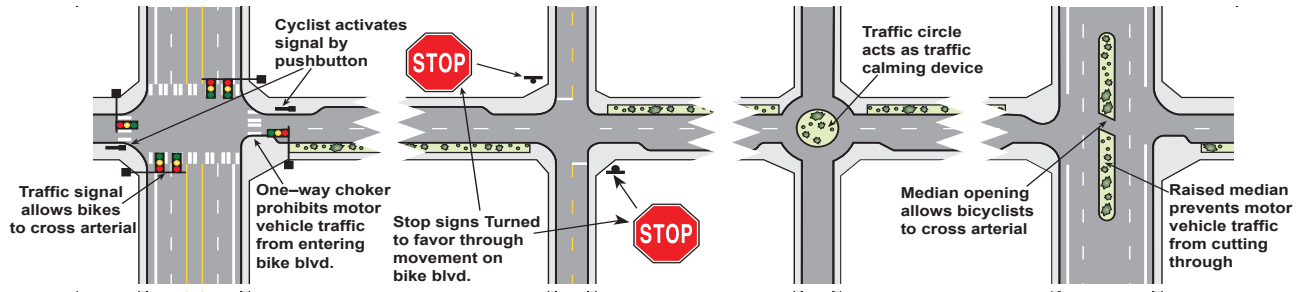

Figure 1-3: Elements of a bicycle boulevard

2. Placing motor vehicle traffic diverter at key intersections to reduce through motor vehicle traffic (diverters are designed to allow through bicyclist movement);
3. Turning stop signs towards intersecting streets, so bicyclists can ride with few interruptions;
4. Placing traffic-calming devices on streets to lower motor vehicle traffic speeds;
5. Placing directional signs or markings to route cyclists to key destinations, to guide cyclists through difficult situations, and to alert motorists of the presence of bicyclists; and
6. Providing crossing improvements where the boulevard crosses high-speed/high-volume streets such as:
 - Signals, where a traffic study has shown that a signal will be safe and effective. To ensure that bicyclists can activate the signal, loop detection should be installed where bicyclists ride and/or a push button that won't require dismounting; or
 - Median refuges, wide enough to provide a refuge (8 feet min) and with an opening wide enough to allow bicyclists to pass through (6 feet). The design should allow bicyclists to see the travel lanes they must cross.



Traffic diverter limits motor vehicle traffic while allowing bicycles to proceed thru



Bicyclist waits at island to cross busy street



Mini circle slows traffic, creating conditions needed for shared roadway

Potential bicycle boulevard implementation problems

Problems can arise under these conditions:

1. If they're discontinuous and/or located on streets that do not provide direct access to commerce and other destinations, cyclists will have to negotiate a more hostile street environment to complete portions of their trip. *Bike boulevards must be continuous and close to corridors that serve many destinations; short connections may have to be built to provide continuity and access.*
2. They can cause motor vehicle traffic diversion onto other streets. *Neighborhood concerns must be properly addressed.*
3. Failure to provide adequate crossings of busy streets can result in unsafe conditions for bicyclists. *The planning phase must develop realistic and fundable strategies for crossings of busy streets.*

Shoulder Bikeways

Besides giving an area for cyclists to ride, paved shoulders are provided on rural highways for a variety of safety, operational and maintenance reasons such as:

- Motorists can stop out of traffic in case of emergency, or escape potential crashes; and
- Storm water can be discharged farther from the motor vehicle travel lanes, helping to preserve the pavement.

Width

In general, the shoulder widths recommended for rural highways in the ODOT Highway Design Manual serve bicyclists well; HDM Table 7-2 should be used when determining shoulder widths:

Average Daily Traffic	< 400	400-1500	1500-2000	> 2000
Rural Arterials	4'	6'	6'	8'
Rural Collectors	2'	5'	6'	8'
Rural Local Roads	2'	5'	6'	8'

Table 1-2: Rural road shoulder widths

When providing shoulders for bicycle use, a width of 6 feet is recommended. This allows a cyclist to ride far enough from the edge of pavement to avoid debris, yet far enough from passing vehicles to avoid conflicts. If there are physical width limitations, a minimum 4 foot shoulder may be used.

Shoulders adjacent to a curb face, guardrail or other roadside barriers must be 5 feet wide, as cyclists will “shy” away from a vertical face. Shoulders adjacent to a curb should have 4 feet of pavement from the longitudinal joint at the gutter pan. Curbed sections usually indicate urban conditions, where shoulders should be striped as bike lanes.

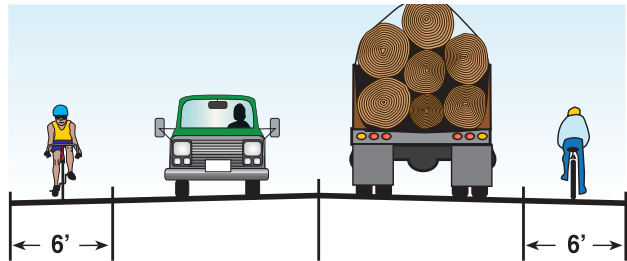

Figure 1-4: Shoulder bikeway

On steep uphill grades, it is desirable to maintain a 6-foot (min. 5-foot) shoulder, as cyclists need more space for maneuvering.

Note: many rural roads are 28 feet wide, with fog lines striped at 11 feet from centerline. The remaining 3 feet should not be considered a shoulder bikeway (min. 4 feet); these are shared roadways, as most cyclists will ride on or near the fog line. But they provide an enjoyable riding experience where traffic volumes are low to moderate.

Pavement Design and Construction

Many existing gravel shoulders have sufficient width and base to support shoulder bikeways. Minor excavation and the addition of 3-4 inches of asphaltic concrete is often enough to provide shoulder bikeways. Pavement overlays provide the best opportunity to widen shoulders for several reasons:

- The base lift of asphalt adds structural strength;
- The final, full width lift is smooth, with no joint; and
- The unit costs are less, as greater quantities of materials will be purchased.



Higher volume rural road with shoulders

When shoulders are provided as part of new road construction, the pavement structural design should be the same as that of the roadway.

On shoulder-widening projects, there may be some opportunities to reduce costs by building to a lesser thickness if the following conditions are met:

- There are no planned widening projects for the road section in the foreseeable future;
- The existing shoulder and roadbed are stable and there is adequate drainage;
- The existing travel lanes are in stable condition and of adequate width;
- The horizontal curvature is not excessive, so the wheels of large vehicles do not track onto the shoulder; and
- The existing and projected ADT and heavy truck traffic are not excessive.

The thickness of pavement and base material will depend upon local conditions, and engineering judgment should be used. If there are short sections where the travel lanes must be reconstructed or widened, these areas should be constructed to normal full-depth standards.

Joint between the shoulders and the existing roadway

The following techniques should be used to add paved shoulders to roadways where no overlay project is scheduled; in all cases the joint should not land in the shoulder, where bicyclists ride:

1. **Saw Cut:** A saw-cut inside the existing edge of pavement provides the opportunity to construct a good tight joint. This eliminates a ragged joint at the edge of the existing pavement.

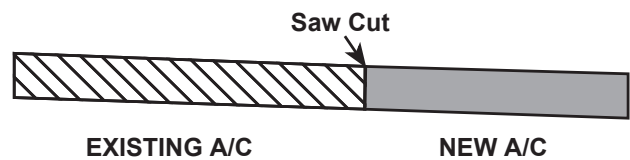

Figure 1-5: Saw cut before adding shoulder

2. **Feathering:** Feathering the new asphalt onto existing pavement works if a fine mix is used and the feather does not extend across the area traveled by bicyclists.

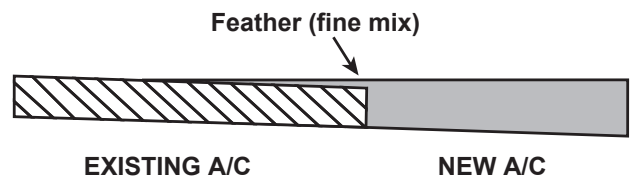

Figure 1- 6: Feathering a shoulder

3. **Grinder:** Where there is already some shoulder width and thickness available, a pavement grinder can be used to make a clean cut at the edge of travel lane, grind the existing asphalt to the right depth and cast aside the grindings in one operation, with these advantages:
 - Less of the existing pavement is wasted;
 - The existing asphalt acts as a base;
 - There will not be a full-depth joint between the travel lane and the shoulder; and
 - The grindings can be recycled as base for the widened portion.

New asphalt can then be laid across the entire width of the shoulder bikeway with no seams.

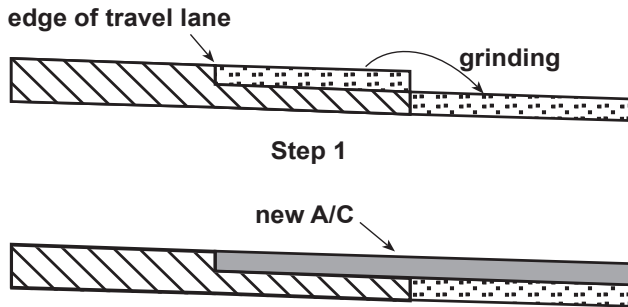

Figure 1-7: Grinding and inlaying a shoulder

In all cases care must be taken to avoid a rough joint in the area where cyclists ride.

Gravel Driveways and Approaches

Wherever a highway is constructed, widened or overlaid, all gravel driveways and approaches should be paved back to prevent loose gravel from spilling onto the shoulders. ODOT standards are 20 feet for driveways, 30 feet for public road approaches.

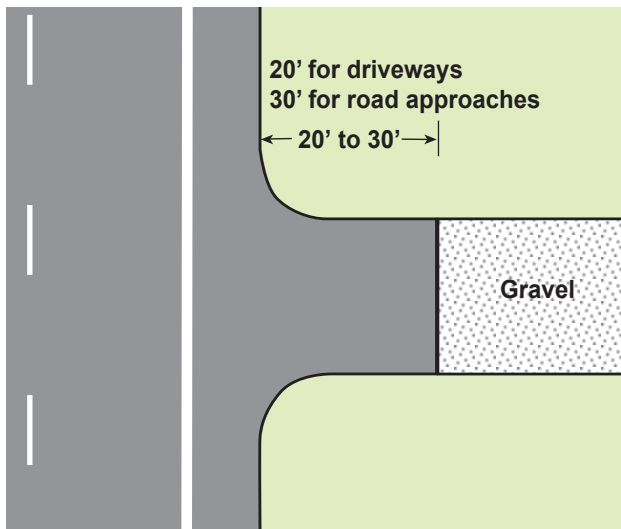

Figure 1-8: Gravel driveway paved to limit gravel on shoulders

Where possible, the paved section of the approach to the highway should be sloped downward away from the highway to reduce the loose material tracked on the shoulder.



Paved driveway apron keeps gravel off shoulder

Bike Lanes

Bike lanes are a portion of the roadway designated for preferential use by bicyclists, and are provided on busy urban and suburban streets (arterials and some collectors). Motorists are prohibited from using bike lanes for driving and parking, but may use them for emergency avoidance maneuvers or breakdowns. Refer to the DMV “Oregon Motorized Scooter Pocket Bike Guide” for a list of vehicles allowed and prohibited in bike lanes <http://www.oregon.gov/ODOT/DMV/docs/pocketbikeguide.pdf>.



Typical bike lane on urban higher speed/volume roadway

Bike lanes may also be provided on rural roadways near urban areas, where there is high bicycle use. Bike lanes are generally not recommended on local streets with relatively low traffic volumes and speeds. In this case a shared roadway is the appropriate facility. Urban arterials should have paved shoulders. Bike lanes are created by adding an 8 inches stripe and stencils.

Bike lanes are generally not recommended on high-speed rural highways; at channelized intersections, the speeds are too high to place a through bike lane to the left of right-turning vehicles (see Chapter 4, Intersection Design). Shoulder bikeways, striped with a 4 inches fog line, are the appropriate facility for these roads.

For planning purposes, refer to the Bike Lane Matrix on page 1-3 to determine whether bike lanes are needed or appropriate for any given roadway.

Advantages of bike lanes:

- Bike lanes enable cyclists to ride at a constant speed, even when traffic in the adjacent travel lanes speeds up or slows down, for example at intersections.
- Bike lanes enable bicyclists to position themselves where they will be visible to motorists.
- Bike lanes encourage cyclists to ride on the streets rather than the sidewalks.

Bike lanes are one-way facilities that carry bicycle traffic in the same direction as adjacent motor-vehicle traffic. Bike lanes should always be provided on both sides of a two-way street. One exception may be on steep hills where topographical constraints limit the width to a bike lane on one side only; in these cases, a bike lane in the uphill direction is acceptable as cyclists ride slower uphill. They can ride in a shared lane in the downhill direction.

Width

The standard width of a bike lane is 6 feet, as measured from the center of stripe to the curb or edge of pavement. This width enables cyclists to ride far enough from the curb to avoid debris and drainage grates, yet far enough from other vehicles to avoid conflicts. By riding away from the curb, cyclists are more visible to motorists than when hugging the curb.

The minimum bike lane width is 4 feet on open shoulders, or 5 feet from the face of a curb, guardrail or parked cars. A 4-foot (min 3 feet)

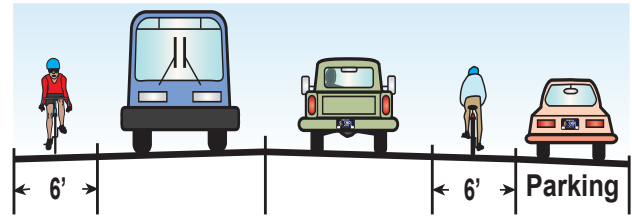

Figure 1-9: Typical bike lane dimensions

wide smooth asphalt surface should be provided to the left of a longitudinal joint between asphalt pavement and the concrete gutter section. It is preferable to pave the bike lane to the curb face to avoid a longitudinal joint in the bike lane.

Shoulders wider than 6 feet may be marked as bike lanes in areas of very high use, on high-speed facilities where wider shoulders are warranted, or where they are shared with pedestrians. Care must be taken so they are not mistaken for a motor vehicle lane, turn lane or parking area, with adequate marking or signing.

A bike lane should be marked with pavement stencils and an 8 inches stripe. This width increases the visual separation of a motor vehicle lane and a bike lane. The 8-inch white stripe is a legal requirement in Oregon (OAR 734-20-055). Refer to page 1-19 for bike lane marking standards.

If on-street parking is permitted, the bike lane must be placed between parking and the travel lane, and be at least 5 feet wide.

Bike Lanes on One-way Streets

Bike lanes on one-way streets should be on the right side of the roadway and should always be provided on both legs of a one-way couplet. The bike lane may be placed on the left of a one-way street if it decreases the number of conflicts, e.g., those caused by heavy bus traffic or dual right-turn lanes, and if cyclists can safely and conveniently transition in and out of the bike lane on the left. (See *Chapter 6* for detailed information on bike lane configurations at intersections.)



Bike Lane on one way street

Contra-Flow Bike Lanes

Though riding against traffic on a one-way street is illegal, many cyclists do this if it avoids circuitous out-of-direction travel; in other instances cyclists are observed riding on the sidewalk against the flow of traffic. Rather than condone or try to prohibit these movements, contra-flow bike lanes on a one-way street should be considered under the following circumstances:

- The contra-flow bike lane provides a substantial savings in out-of-direction travel and/or direct access to high-use destinations.
- Safety is improved because of reduced conflicts compared to the longer route.
- There are few intersecting driveways, alleys or streets on the side of the contra-flow lane.
- Bicyclists can safely and conveniently transition in and out of the bike lane at either end of the block.
- The street is wide enough for a bike lane.

A contra-flow bike lane may also be appropriate on one-way residential streets; this allows cyclists to access the street in both directions.

For a contra-flow bike lane to function well, these features should be incorporated into the design:

- The contra-flow bike lane must be placed on the right hand side of the street (to motorists' left), separated from on-coming traffic by a double yellow line. This

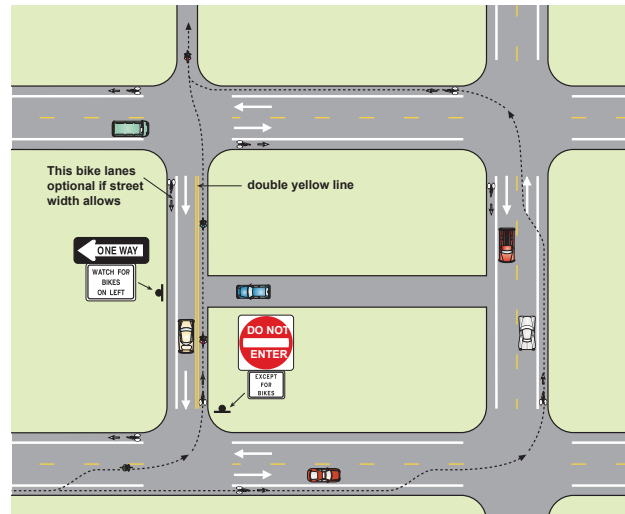

Figure 1-10: Contra-flow bike lane reduces out of direction travel

establishes two-way operation for bicyclists, who are riding on the street legally, in a dedicated travel lane.

- Bike lane stencils and arrows must be used to clearly indicate direction of travel, and to discourage cyclists from using the bike lane against the normal traffic flow.
- Intersecting alleys, major driveways and streets must have signs indicating to motorists that they should expect two-way bicycle traffic.



Contra-flow bike lane: One way for cars, two way for bicycles

Existing traffic signals should be fitted with special signal heads for bicyclists; this can be activated with either loop detectors or push-buttons (these should be easily reached by bicyclists without having to dismount).

Notes:

1. Where there is insufficient room to provide a bike lane in each direction, it is not necessary to provide a bike lane in the direction of prevailing traffic; bicyclists and motorists can share the road.
2. A contra-flow bike lane should not be installed on a two-way street, even where the travel lanes are separated with a raised median.

Bike Lanes and Diagonal Parking

Diagonal parking can cause conflicts with bicyclists: drivers backing out have poor visibility of oncoming cyclists and parked cars obscure other vehicles backing out.

This is mitigated by the slower traffic speeds found on streets with diagonal parking, and cyclists ride close to the center of the adjacent travel lane. Bike lanes may be placed next to diagonal parking if the following recommendations are implemented:

- The parking bays are long enough to accommodate most vehicles, or long vehicles are prohibited;
- A 4 inches stripe separates the bike lane from parking; and
- Enforcement actively cites or removes vehicles encroaching into the bike lane.

Consider back-in diagonal parking: Back-in diagonal parking creates conditions advantageous to all traffic, including bicyclists: drivers can pull into the traffic stream with a good view of oncoming traffic, including bicyclists.

Note: approval from the State Traffic Engineer is required for diagonal parking on state highways.

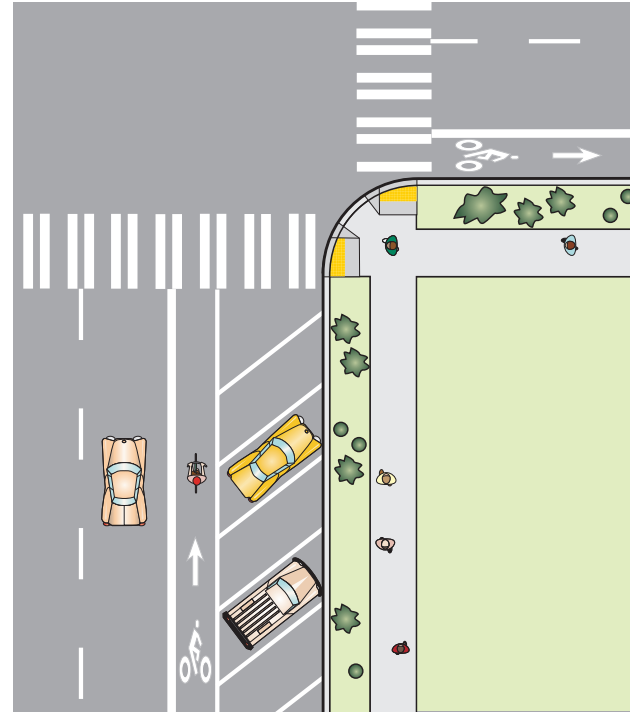

Figure 1-11: Bike lane next to diagonal parking

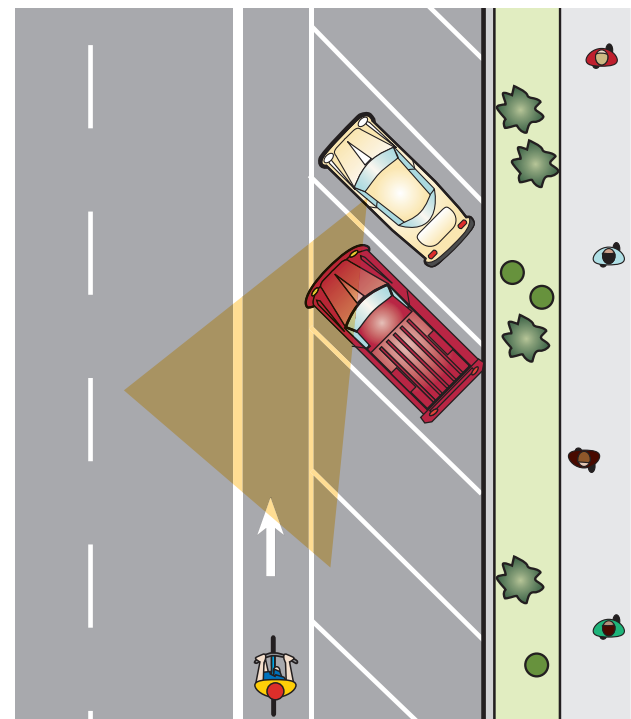

Figure 1-12: Back in diagonal parking and bike lane

Bike Lanes & Bus Lanes

In most instances, bicycles and buses can share the available road space. On routes heavily traveled by both bicyclists and buses, separation can reduce conflicts (stopped buses hinder bicycle movement and slower moving bicycles hinder buses).

Separate bus lanes and bike lanes should be considered to reduce conflicts between passengers and bicyclists, with the bus lane at the curb side. Buses will be passing bicyclists on the right, but the fewer merging and turning movements reduce overall conflicts.



Bike lane to left of bus lane

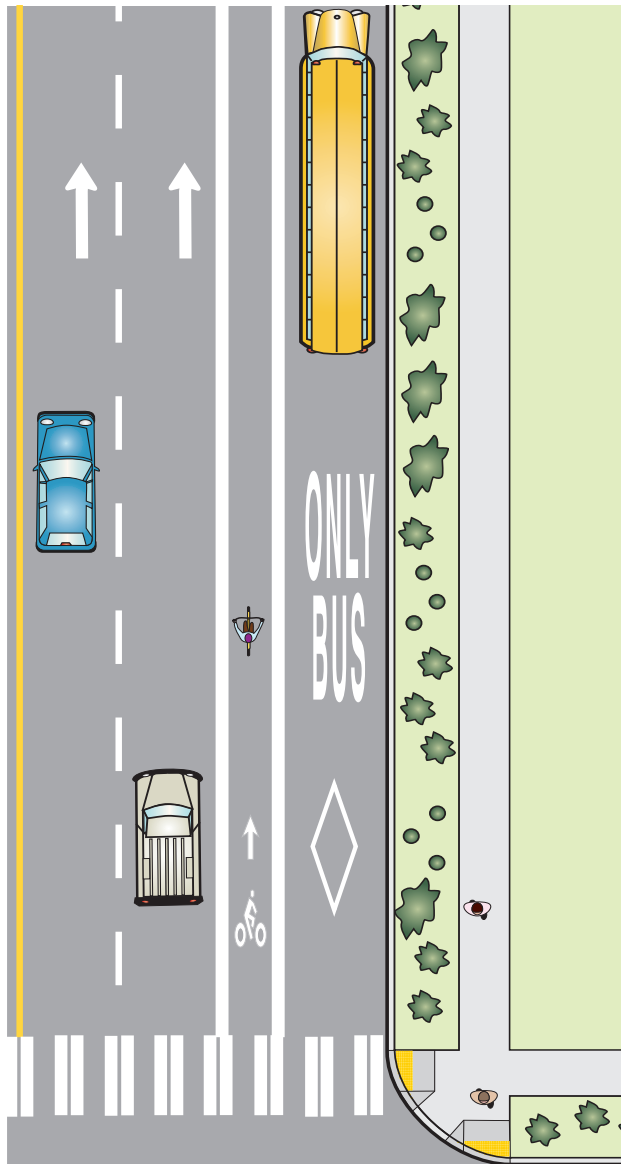

Figure 1-13: Bike lane to the left of bus lane

Colored Bike Lanes

Residents often express a desire to narrow a roadway to slow traffic, and so the highway has less of a visual impact on the community. Bike lanes can make a road look wider. To mitigate this effect, bike lanes can be colored so the motor vehicle space appears narrower.

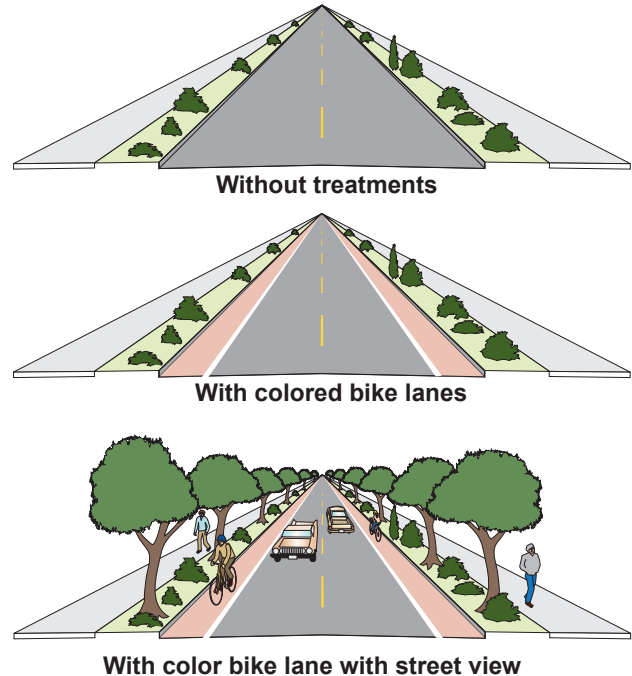

Figure 1-14: Colored bike lanes “narrow” roadway

There are several methods available for coloring bike lanes still under evaluation. The best is to pave the bike lanes separately, using

dyed asphalt. This requires two passes of the paving machine; care must be taken to avoid a rough joint between the bike lane and the travel lanes. Another method is to cover the bike lane with a tinted slurry seal.

Colored bike lane “narrows” street

A further method is to extend the concrete gutter pan the full width of the bike lane (5 or 6 feet). The contrast between the concrete and the asphalt roadway makes the latter appear narrower. However, concrete gutter pans can be a very uncomfortable ride for bicyclists if not constructed well: it is imperative the joints be saw-cut, not trowelled, to avoid bumps in the bike lane. When the roadway is resurfaced, the top lift of asphalt must be milled down and removed, so the new surface is flush with the gutter pan.



Colored bike lane “narrows” street



Concrete bike lane provides contrast with asphalt roadway

An 8 inches white stripe is still necessary to delineate and designate the bike lane. The 8 inches stripe can straddle the travel lane and bike lane if they are both constructed of the

same material. When the bike lane is concrete and the travel lanes are asphalt, the 8 inches stripe should be wholly contained on the asphalt portion for greater visibility.

Note: approval from the State Traffic Engineer is required for colored bike lanes on state highways.

Alternatives to Bike Lanes on Main Thoroughfares: Guidelines for Providing Bikeways on Parallel Routes

There are occasions when it is infeasible or impractical to provide bike lanes on a busy thoroughfare, or the thoroughfare does not serve the mobility and access needs of bicyclists. The following guidelines should be used to determine if it is more appropriate to provide facilities on a parallel local street:

1. a. Conditions exist such that it is not economically or environmentally feasible to provide adequate bike lanes on the thoroughfare; or
 - b. Thoroughfare does not provide adequate access to destination points within reasonable walking distances; or
 - c. Bike lanes on the thoroughfare would not be considered safe.
2. Parallel route must provide continuity and convenient access to facilities served by the thoroughfare;
3. Costs to improve parallel route should be no greater than costs to improve the thoroughfare; and
4. Proposed facilities on parallel route must meet state standards for bike facilities.

The above criteria should be satisfied and considered along with other factors when considering parallel routes for the provision of bike access and mobility.

SURFACE TREATMENTS

Pavement condition is important to cyclists, as they ride on lightweight two-wheeled vehicles with narrow, high-pressure tires (necessary for the bicycle's inherent efficiency). Rough surfaces and imperfections such as joints can cause a rider to lose control and fall. Debris such as gravel and glass are also problems, and these can be addressed through maintenance. Adequate drainage is critical to cyclists, as they ride in the area where water ponds when drains get clogged, or surface irregularities prevent water from entering drain grates.

Surface Types

The preferred roadway surfacing for bicycling is a finely graded asphaltic concrete. Rough open-graded mixes are very uncomfortable for cyclists, as they cause vibrations and increased rolling resistance, contributing to greater cyclist fatigue.



Chip seal ends at motor vehicle travel lane

Chip Seals

Chip-sealed surfaces are particularly unpleasant to ride on and should be avoided when possible. Where used, chip seals should be limited to the travel lanes on roads and highways with paved shoulders: the shoulders should NOT be chip-sealed. On roads with no shoulders (where cyclists ride in the travel lanes), chip seals should use a fine mix and be covered with a fog or slurry seal.

Drainage Grates

Care must be taken to ensure that drainage grates are bicycle-safe, as required by ORS 810.150. If not, a bicycle wheel may fall into the slots of the grate causing the cyclist to fall. Replacing existing grates (A, B, preferred methods) or welding thin metal straps across the grate, perpendicular to the direction of travel (C, alternate method) is required. These should be checked periodically to ensure that the straps remain in place.

Note: grates with bars perpendicular to the roadway must not be placed at the bottom of curb cuts, as wheelchairs could get caught in the slot.

If a street-surface grate is required for drainage (ODOT types G-1, G-2, CG-1 and CG-2), care must be taken to ensure that the grate is flush with the road surface. Inlets should be raised after a pavement overlay to within 1/4 inch of the new surface. If this is not possible or practical, the pavement must taper into drainage inlets so they do not cause an abrupt edge at the inlet.

The gap between the grate and the inlet should be kept tight, no more than 3/4 inch, to prevent bicycle wheels from getting trapped.

The most effective way to avoid drainage-grate problems is to eliminate them entirely with the use of inlets in the curb face (type CG-3). The cross-slope of the outer 3 feet or so of the bike lane should stay constant, with no exaggerated warping towards the opening. This may require more grates per mile to handle bypass flow; but this is the most bicycle-friendly design.

Another bicycle-friendly option is to ensure the inlet grate is entirely contained in the gutter pan.

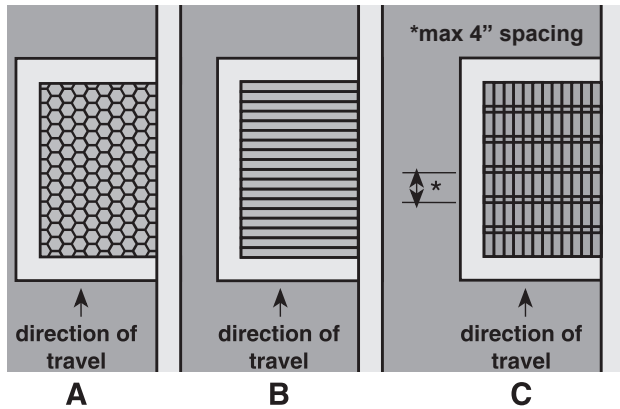

Figure 1-15: Bicycle safe drainage grates

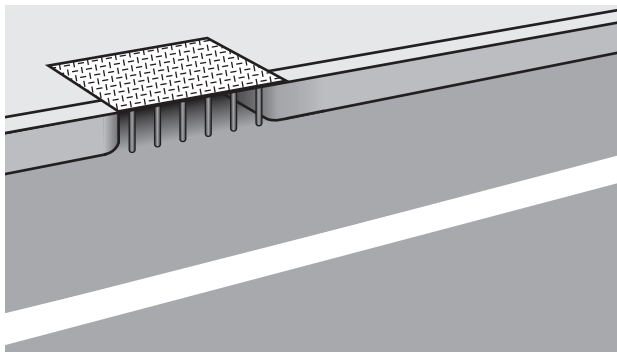

Figure 1-16: Curb inlet drainage grate

Railroad Crossings

Special care must be taken wherever a bikeway intersects railroad tracks. The most important concerns for bicyclists are smoothness, angle of crossing and flange opening.

The combination of smoothness, angle and flange opening create conditions that affect cyclists. By improving smoothness and flange opening, the angle becomes less critical. A common mistake is to overcorrect for the angle, as the resulting sharp reversing curves needed to create a right angle crossing can be more difficult for cyclists to negotiate than the crossing itself. Sometimes all that is needed is a slight widening of the shoulders to allow cyclists to align themselves better at the track crossing.

By statute, all public highway, bikeway, shared-use paths, and sidewalk crossings of a railroad in Oregon are regulated by the Rail Division of the Department of Transportation. The Rail Division must approve, by issuance of an

Order, the construction of new crossings or alterations to existing crossings, to include the approaches to these crossings. Crossing Orders specify construction details, installation of traffic control devices, and assign maintenance responsibilities to the road authority and the railroad, who are parties to the application.



Concrete RR crossing with rubber flanges

Crossing Surface

The four most commonly used materials, in descending order of preference, are:

- **Concrete:** Concrete performs best under wet conditions and, when laid with precision, provides a smooth ride.
- **Rubber:** Rubber provides a rideable crossing when new, but they are slippery when wet and degrade over time.
- **Asphalt:** asphalt pavement must be maintained in order to prevent a ridge buildup next to the rails.
- **Timber:** Timbers wear down rapidly and are slippery when wet.

Crossing Angle

The risk of a fall is kept to a minimum where the roadway (or bikeway portion of the roadway) crosses the tracks at 90°. If the skew angle is less than 45°, special attention should be given to the bikeway alignment to improve the angle of approach, preferably to 60° or greater, so cyclists can avoid catching their

wheels in the flange and losing their balance. OAR 741-115-0070 specifies regulations for bicycle lanes and multi-use paths that cross railroad tracks at the same grade. Under OAR 741-115-0070 (3), an engineering study is required whenever bicycle lanes or multi-use paths are proposed to cross railroad tracks at 59 degrees or less.

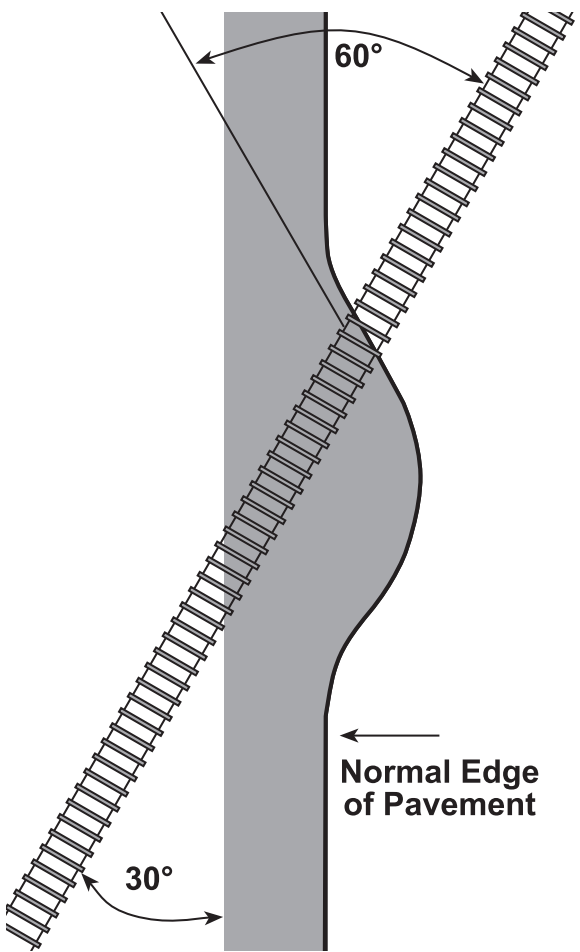

Figure 1-17: Bulged RR crossing

Efforts to create a right-angle crossing at a severe skew can have unintended consequences: the reversing curves required for a right-angle approach can create other problems for cyclists. It is often best to widen the roadway, shoulder or bike lane to allow cyclists to choose the path that suits their needs the best. On extremely skewed crossings (30° or less), it may be impracticable to widen the shoulders enough to allow for 90° crossing; widening to allow 60° crossing or better is often sufficient.

Creating a separated path to angle the bikeway at 90° degrees is feasible, but special care should be taken to maintain the path regularly.



Rail crossing S curve

Flange Opening

The open flange area between the rail and the roadway surface can cause problems for cyclists, since it can catch a bicycle wheel, causing the rider to fall. Flange width must be kept to a minimum.



Bicycle unfriendly RR crossing

Rumble Strips

Rumble strips are provided to alert motorists that they are wandering off the roadway. They are most common on long sections of straight freeways in rural settings, but are also used on some two-lane undivided highways. Rumble strips should not extend across the entire width of the shoulder, because they create an unridable surface for bicyclists. Rumble strips should not be used if they leave less than 4 feet of rideable space.

Bicycle friendlier rumble strips adjust the placement and width of the rumble strip and provide gaps for bicyclists to leave the shoulder to make a left turn or to avoid debris. A minimum of 4-feet of rideable shoulder is required and 12-foot gaps on 40 to 60 foot intervals is recommended. On narrower shoulders rumble strips can also be cut directly at the fog line, leaving the entire shoulder available for cycling. Rumble strips must be dropped before pinch points.

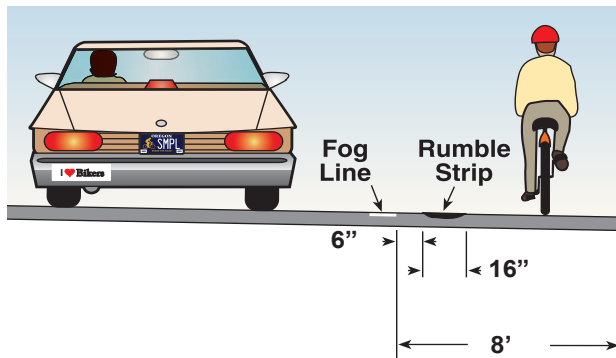

Figure 1-18: Bicycle friendlier rumble strips



Well placed rumble strip leaves room for bicyclists

Another alternative is the use of profiled fog lines. They are highly retro-reflective, alert drivers when they've strayed from the travel way, and leave the entire width of the shoulder available for bicycling. Should a bicyclist need to cross the fog line occasionally, the bumps are not too severe. They should not be used on narrow shoulders (under 4 feet) as they will be located in the area where cyclists prefer to ride.

For the most up-to-date information on rumble strip placement, design and alternatives, refer to the ODOT Traffic Manual and standard drawings.



Profiled edge stripe

SIGNING AND MARKING OF BIKEWAYS

Introduction

Signing and marking of bikeways must be uniform and consistent for them to command the respect of the public and provide safety to users. Signing and marking must be warranted by use and need. Signing and markings of bikeways on the state highway system should conform to the recommendations of this section. To provide uniformity and continuity, cities and counties are encouraged to adopt these standards. Consult the MUTCD, the ODOT Traffic Manual and the ODOT Traffic Line Manual for up-to-date details and dimensions.

Well-designed roads make it clear to users how to proceed, and require very little signing. Conversely, an over-abundance of warning and regulatory signs may indicate a failure to have addressed problems. The attention of drivers and bicyclists should be on the road and other users, not on signs on the side of the road. Over-signing degrades the usefulness of signs, causes distractions, creates a cluttered effect, is ineffective and wastes resources.

Language Barriers: The message conveyed by signs should be easily understandable by all roadway users: symbols are preferable to text.

Sign Placement: Signs placed adjacent to roadways must conform to adopted standards for clearance and breakaway posts and should never block the accessible pedestrian route.

Shared Roadways

Signing

In general, no signs are required for shared roadways. Bicyclists should be expected on all urban local streets, which are mostly shared roadways.

The W11-1 sign alone indicates a bicyclist crossing point. To inform roadway users that bicyclist can be expected in the travel lane it may be helpful to install bike warning signs (W11-1) with the supplemental plaque ON ROADWAY (OBW1-5) or ON BRIDGE ROADWAY (OBW1-7). Signs should be placed in advance of the roadway condition and are primarily used to indicate a short segment of shared travel lane. If the roadway condition is continuous, an additional rider “NEXT XX MILES” may be used.

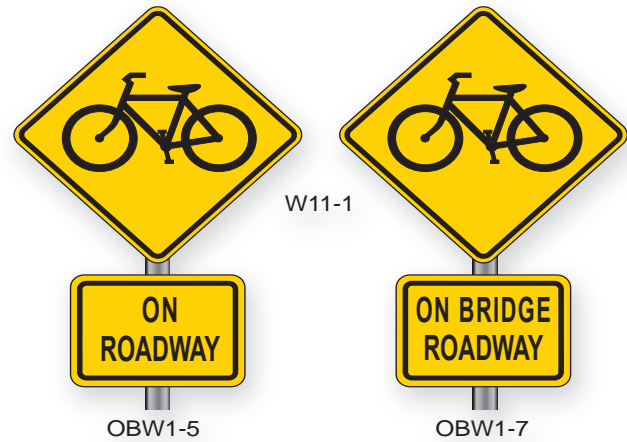

Figure 1-19: W11-1 with riders

The SHARE THE ROAD (W16-1P) rider indicates a shared travel lane. It is specific to bicyclists only when paired with W11-1 and has the same function as the sign combinations shown above. ODOT convention is to use the W11-1 plus OBW1-5 or OBW1-7.



Figure 1-20: W16-1P

CW11-1 Should be used in temporary work zones to indicate a shared lane condition.



Figure 1-21: CW11-1

R4-11 is regulatory and is used to indicate a permanent shared lane condition. It may be used in conjunction with the shared lane marking (sharrow). The need to use R4-11 is an indication that the bicycling facility is not intuitive, nor comfortable for most bicyclists. Better quality bicycle accommodation should be provided in lieu of signs. See the MUTCD for further guidance.



Figure 1-22: R4-11

Directional and route signs are useful where bicyclists are directed to follow a routing that differs from the routing recommended for motorists. The routing must have obvious advantages over other routes, such as safety, convenience, or when the main roadway is hostile to bicycles. BIKE ROUTE (D11-1) signs lack sufficient information and often lead to areas poorly suited for bicycling. Better options exist. Bicycle destination guide signs are preferred.



Figure 1-23: D11-1

The Portland Bureau of Transportation, in cooperation with ODOT, developed the OBD1 series of bicycle route guide signs, the preferred sign series in Oregon. Additionally, the MUTCD (2009 edition) D1 sign series provides any number of bicycle route guide sign options.

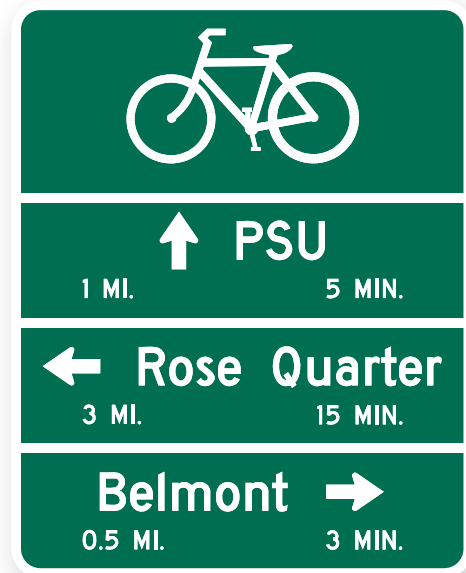

Figure 1-24 Bicycle route guide sign OBD1-3c

Bicycle route guide signs are used to indicate a preferred route for bicyclists. They should be used when the signed route provides a clear advantage to bicyclists such as:

- A low volume street
- A short cut
- A flatter route
- A bicycle boulevard
- A bicycle specific destination
- An alternate to a busy, bicycle unfriendly thoroughfare

The b-series signs are used for multi-modal routes. The c-series provides travel time and distance information.

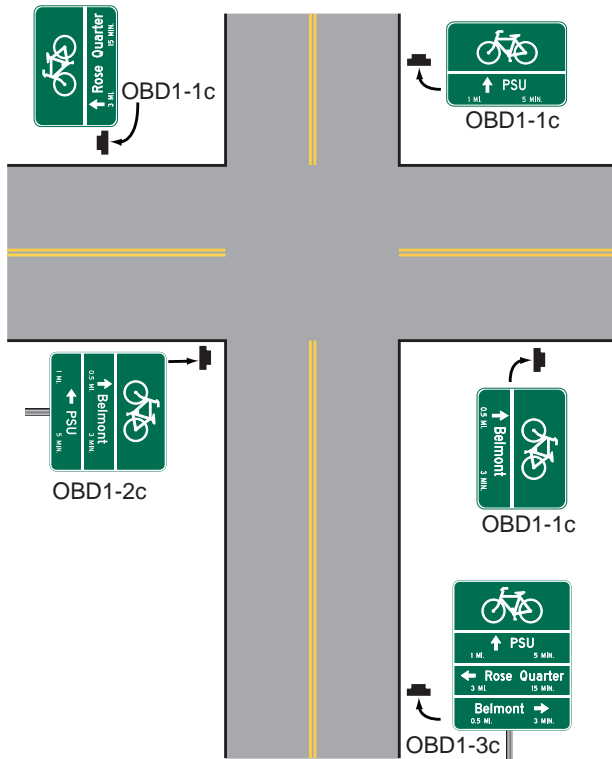

Figure 1-25: MUTCD Figure 9B-6 with Oregon Supplement OBD1 signs

Bike Boulevards

Signing and marking conventions for bicycle boulevards continue to evolve. OBD1-3c signs should be adequate to convey route information to cyclists. Additionally, Portland and Eugene have developed bike boulevard route signs by adding the name of the bike boulevard, complimented with a Designated Bicycle Boulevard pavement marking.



1st Generation bicycle boulevard pavement marking



2nd Generation bicycle boulevard pavement marking (indicates turn)

Sharrows

Sharrows, also known as “shared lane markings,” are a new form of pavement marking included in the 2009 MUTCD. They are primarily intended for use on narrow, low-speed roadways with on-street parking. Their primary purposes are to:

- Encourage bicyclists to ride away from the door zone; and
- Indicate to drivers where to expect cyclists.

Sharrows should be used on streets with high bicycle demand, and where there is potential competition for the use of a narrow lane. Early observations indicate that bicyclists ride further from parked cars (reducing their risk of being hit by an opening car door), and drivers more safely share the road with bicyclists.



Sharrows indicate where bicyclists should position themselves in the roadway

Shoulder Bikeways

Signing

In general, no signs are required for shoulder bikeways. Bicyclists riding on shoulder bikeways are well served with adequate width and smooth pavement.

Marking

A normal 4 inches wide fog line stripe is used on shoulder bikeways.



Shoulder bikeway on higher volume rural road

Bike Lanes

Bike Lane Designation

Bike lanes are officially designated to create an exclusive or preferential travel lane for bicyclists with the following markings:

- An 8 inches white stripe; and

- Bicycle symbol and directional arrow stencils.

Where a bike lane is next to parking, parking should be defined by parking space markings or a solid 4 inches stripe. Optional NO PARKING signs (R7-9 and R7-9a) may be installed if problems with parked cars occur; in many jurisdictions, painting curbs yellow indicates that parking is prohibited. Where the bike lane ends, sign OBW1-9 may be used where cyclists enter the motor vehicle travel lanes.

Stencil Placement

Stencils should be placed after most intersections; this alerts drivers and bicyclists entering the roadway of the exclusive nature of the bike lanes. Stencils should be placed after every intersection where a parking lane is placed between the bike lane and the curb.



Figure 1-26: Oregon standard bike lane marking



Figure 1-27: OBW1-9

Supplementary stencils may also be placed at the end of a block, to warn cyclists not to enter a bike lane against traffic.

Additional stencils may be placed on long sections of roadway with no intersections. A rule of thumb for appropriate spacing is: multiply designated travel speed by 40. For example, in a 35 MPH speed zone, stencils may be placed approximately every 1400 feet.

Placing stencils outside where motor vehicles are expected to cross a bike lane, such as driveways and the area immediately after an intersection will help reduce maintenance costs, as vehicles won't drive over the stencils repeatedly.



Figure 1-28: Standard bike stencil

Intersections

Bike lanes should be striped to a marked crosswalk or a point where turning vehicles would normally cross them.

Bike lanes are not normally striped through intersections; however, it may be appropriate to do so where extra guidance is needed; in this case, they may be marked with 8 inches wide dotted lines, to guide bicyclists through a long undefined area or to alert turning motorists of the presence of bicycle traffic.

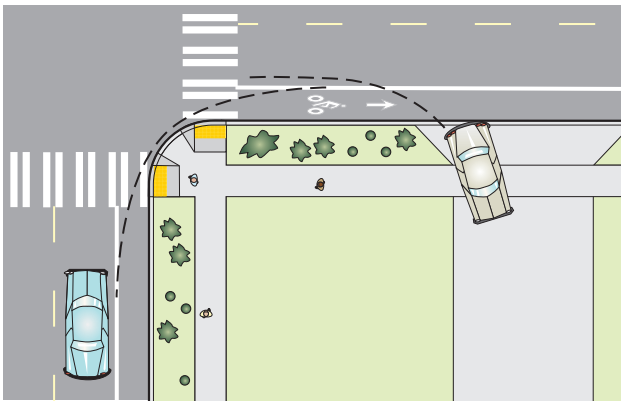

Figure 1-29 : Bike stencil placed out of wheel path

Right Turn Lanes at Intersections

The through bike lane to the left of a right-turn lane must be striped with two 8 inches stripes and connected to the preceding bike lane with a dotted line (8 inches x 2 feet on 8 feet centers [6 feet gaps]). This lets turning motorists cross the bike lane. A stencil must be placed at the beginning of the through bike lane.

Sign R4-4, BEGIN RIGHT TURN LANE, YIELD TO BIKES, may be placed at the beginning of the taper in areas where a through bike lane may not be expected. For example, on sections of roadway where bike lanes have been added where there weren't any previously.



Figure 1-30: R4-4

Reflectors

Reflectors and raised markings in bike lanes are discouraged as they can deflect a bicycle wheel, causing the cyclist to lose control. If pavement markers are needed for motorists, they should be installed on the motorist's side of the bike lane stripe, and have beveled edges.

Special use signs

Railroad Crossing

Where a shared roadway, shoulder bikeway, bike lane or shared-use path crosses a railway at an unfavorable crossing angle, or if the crossing surface is rough or slippery, warning signs OBW8-19R and OBW8-19L should be used.



Figure 1-31: OBW8-19L

Sidewalk Users

Where bicyclists are allowed to use sidewalks, and the sidewalks are too narrow for safe riding (usually on a bridge), sign OBR10-13 may be used to encourage cyclists to walk.

Bicycle Use of Push-Buttons

Where it is recommended that bicyclists use a push-button to cross an intersection (usually where a shared-use path crosses a roadway at a signalized intersection), the following signs should be used.



Figure 1-32: OBR10-13



Figure 1-33: R10-26

Bike Stencils at Intersections

Many traffic lights are actuated by wire loops placed under the surface of the roadway. An electrical current passes through these loops, creating an electro-magnetic field. When a motor vehicle stops over them, the vehicle's metal disrupts the electro-magnetic field, sending a signal to the traffic controller that a vehicle is waiting for the light turn. Many bicycles don't contain enough conductive metal (steel or aluminum) to trigger the signal, causing frustration.



Figure 1-34: Bike symbol for loop detection placement

To help bicyclists trigger a signal, stencils placed over the most sensitive area of the loop detector indicate to cyclists where to place their bicycles for maximum sensitivity.

Tunnels & Bridges

Where substantial bicycle traffic is expected in a narrow tunnel, the signs OBR10-10 and OBW1-8 may be used; it can be adapted for use on long narrow bridges, especially where there are sight distance constraints.

The push-button sign should be placed at a location that allows cyclists to proceed at a normal speed and enter the tunnel as lights begin to flash. The duration timing of the flashing lights should be based on normal bicycle travel speed, plus an extra margin of safety (though leaving the flashing lights on for too long may render them ineffective if motorists enter the tunnel and cyclists are no longer present).

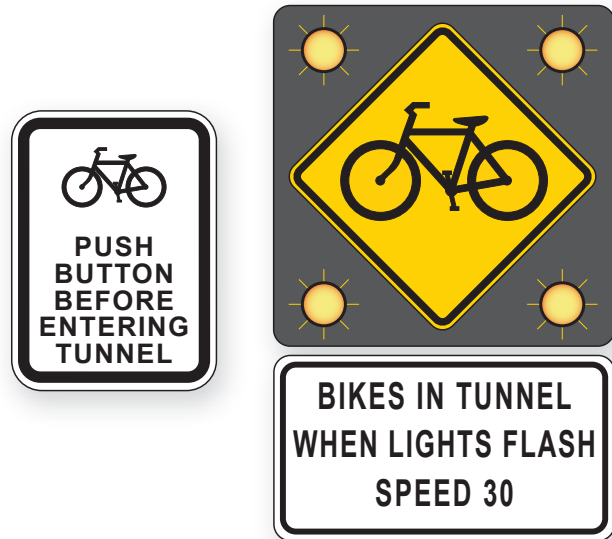

Figure 1-35: OBR 10-10 and OBW 1-8

Touring Routes

Special signs have been created to guide cyclists along state and national touring routes, such as the Oregon Coast Bike Route, Oregon Scenic Bikeways and US National Numbered Bike routes:



Figure 1-36: OBD 11-3

These signs should be used sparingly, mainly at intersections (with right or left turn arrows) to guide cyclists along the route.



Figure 1-37: OBM 1-8

Bicycle Races and Events

For a complete description of measures to be taken for bicycle races and events, please consult the “Guidelines for Administration of Bicycle Racing on Oregon Roads.” <http://www.oregon.gov/ODOT/HWY/BIKEPED/docs/bikerace.pdf?ga=t>

Sign design specifics can be found in the ODOT Sign Policy and Guidelines, Chapters 6 and 8: http://www.oregon.gov/ODOT/HWY/TRAFFIC-ROADWAY/sign_policy.shtml

For events routed over county and city roadways consult with the local roadway authorities for their requirements.

Temporary Work Zones

Construction and other temporary work zones should provide safe passage for bicyclists. ODOT Sign Policy and Guidelines, Chapters 6 and 8 (http://www.oregon.gov/ODOT/HWY/TRAFFIC-ROADWAY/sign_policy.shtml) as well as ODOT/APWA Unique Specifications Section 00225 (http://www.oregon.gov/ODOT/HWY/SPECS/unique.shtml#Part_00200) contain route and sign guidelines for directing bicyclists thru temporary work zones.



Bike lane in temporary work zone

Innovative Designs

These concepts are presented as information, to help ODOT, cities and counties with new solutions to common problems. This compendium is provided to encourage creative thinking. Implementation will require more information than is available herein. More information on these facilities can be found in the following guides:

- NACTO (National Association of City Transportation Officials) Urban Bikeway Design Guide: <http://nacto.org/cities-for-cycling/design-guide/>
- Portland (Oregon) Bicycle Master Plan 2030 Bikeway Facility Design Guide: <http://www.portlandonline.com/transportation/index.cfm?a=289122&c=44597>
See Appendix D under Supplemental Documents

Advisory Bike Lanes

Advisory bike lanes are delineated with skip stripe bike lane markings. They are used on low volume, one and two lane roadways where the motor vehicle lanes are not wide enough to allow two cars to pass each other. When there is oncoming traffic the motor vehicle driver must pull into the advisory bicycle lane to pass. The center line on the roadway is omitted. They may require legislative action for implementation.



Advisory Bike Lane

Bike Box

The bike box is a signalized intersection traffic control device used to prevent the right-hook crash. Painted across the entire curb side lane the bike box gives bicyclists priority by positioning them in advance of motor vehicle traffic during the red signal phase. Once the light turns green bicyclists proceed across the intersection to the far side bike lane. The bike lane functions normally during the green phase. Right on red must be prohibited when using the bike box.



Bike Box

Bike Left turn Lane

Bike left turn lanes are used when a bicycle boulevard or other signed bike route continues thru an offset intersection.



Bike left turn lane

Bike Stair Channel

A bike stair channel assists bicyclists using stairs by providing a space in which to insert the bicycle wheels so that a bicycle may be rolled up or down a staircase.



Stair Channel

Bike Passing Lane

When bicycle volumes warrant, a bicycle passing lane provides passing opportunities for higher speed bicyclists.



Bike passing lane

Bicycle Signal

A bicycle traffic signal can be used in conjunction with a bicycle exclusive phase. This can be helpful where high volume motor vehicle turn movements conflict with the thru bike lane.



Bike Signal

Bike Friendly Transit Stop

Routing bicyclists to the rear of a transit stop can help alleviate conflicts.



Bicycle lane to rear of transit stop

Buffered Bike Lane

Buffered bike lanes provide additional separation from the motor vehicle traffic and/or parking lane, increasing bicyclist comfort.



Buffered Bike lane

Choker/Separator

Used to calm and discourage thru motor vehicle traffic on bicycle boulevards, the choker/separator segregates traffic at non-signalized intersections.



Choker/Separator

Cycle Track

A cycle track is a bike lane with a physical barrier between the bike and motor vehicle travel lanes, such as a curb or parking lanes. Cycle tracks provide a very high level of bicyclist comfort. Cycle tracks must “rejoin”

the motor vehicle travel lanes at signalized intersections. Cycle tracks may require a two stage left turn for bicyclists. Cycle tracks are attractive to bicyclists less comfortable in on-street bike lanes.



Cycle Track

Floating Bike Lane

A floating bike lane is a bike lane coincident with the parking lane during peak hours. During peak hours parking is prohibited. Parking is allowed in off peak hours – when bicyclists must use the motor vehicle travel lane.

Green Wave

The green wave was developed in Copenhagen, Denmark. It is a signal timing technique that when partnered with bike lanes or a cycle track, gives priority to thru bicycle travel.

Raised bike lanes

Normally, bike lanes are an integral portion of the roadway and are delineated from motor vehicle lanes with painted stripes. Though most bicyclists ride on these facilities comfortably, others prefer more positive separation; but separated paths are not practical in most urban settings.

Raised bike lanes incorporate the convenience of riding on the street with some physical separation, with these advantages:

- Motorists know they are straying from the travel way when they feel the slight bump created by the curb;
- Mountable curb allows motorists to make turns into and out of driveways;
- Mountable curb allows cyclists to enter or leave the bike lane (for turning left, overtaking another cyclist etc.); and
- Novice bicyclists are more likely to ride in the bike lane, leaving the sidewalk for pedestrians.

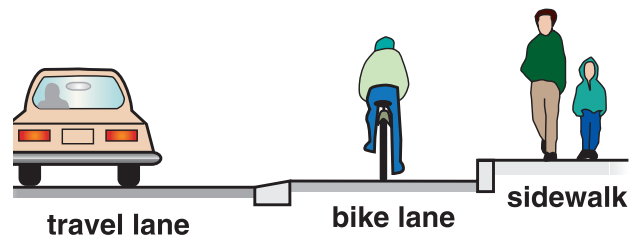

Figure 1-38: Raised bike lane

An effective design provides a gentle (4:1) slope, with no lip, so a bicycle tire is not caught during crossing maneuvers. Using concrete curbs in an asphalt roadway increases the visibility of the bike lane stripe. The raised bike lane drains to the roadway, not the curb or sidewalk; this requires drainage inlets in the travel lanes. The raised bike lane is dropped prior to intersections, where the roadway surfacing is uniform. Raised bike lanes cost more to construct, as the travel lanes and bike lanes must be paved separately and a narrow paving machine is required for paving the bike lane. The additional costs may be mitigated by reduced long-term maintenance costs:

- The bike lane portion receives less wear and tear than the motor vehicle travel lanes;
- The bike lane accumulates less debris, requiring less frequent sweeping; and
- The bike lane stripe doesn't need frequent repainting.

Notes:

- *On roads with parking, the bike lane should be placed between the travel lanes and parked cars, elevating the parking lane.*

- *Raised bike lanes must include the standard stencils and 8 inches white stripe. For better visibility of the 8 inches stripe, it should be placed entirely on the lower surface.*



Raised bike lane

Skinny Street

A skinny street is a type of shared travel lane. By narrowing the roadway motor vehicle travel speeds are reduced.



Skinny Street

Woonerf

A woonerf, developed in The Netherlands, is designed for extremely low motor vehicle travel speeds. When MV travel speeds are reduced below 20 miles per hour, bicyclists, pedestrians and motor vehicle traffic can share the same space.



Woonerf

Practices to be Avoided

The Oregon Department of Transportation has 35 years of experience designing bikeways, and has also learned from local city and county experiences; some practices have proven to be poor ones.

Sidewalk Bikeways

Some early bikeway plans designated sidewalks for bicyclist use. While in rare instances this may be necessary (such as on narrow bridges), or acceptable for use by children, in most cases it should be avoided. Most cities ban bicyclists from sidewalks in business districts.

Cyclists are safer when they function on the roadway as vehicle operators, rather than as pedestrians. Sidewalks are not suited for cycling for several reasons:

- Cyclists face conflicts with pedestrians;
- There are often utility poles, sign posts, benches, etc. placed in sidewalks;
- Bicyclists face conflicts with motor vehicles at driveways, alleys and intersections: a cyclist on a sidewalk is generally not visible to motorists and emerges unexpectedly. This is especially true of cyclists who ride against the flow of adjacent motor vehicle traffic: drivers do not expect cyclists coming from this direction; and

- Bicyclists are put into awkward situations at intersections where they cannot safely act like a vehicle operator but are not in the pedestrian flow either, creating confusion for other road users.

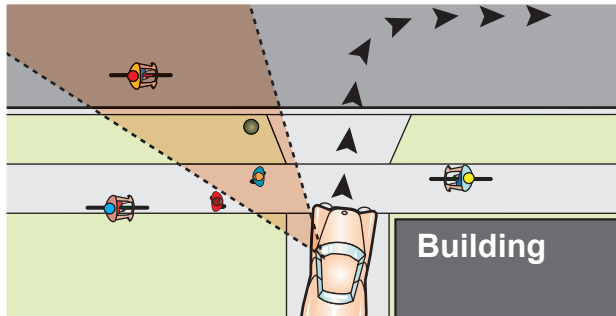

Figure 1-39: Conflicts with sidewalk riding

Where width constraints do not leave room for bikeways, solutions should be sought to accommodate both modes (e.g. narrowing travel lanes). In some urban situations, preference may be given to accommodating pedestrians. Sidewalks should not be signed for bicycle use - the choice should be left to the users.

There are circumstances where it may be advisable to allow bicyclists to ride on a sidewalk: on long narrow bridges with high traffic volumes. This can help cyclists if the bridge sidewalks are wide enough for bicycle use (minimum 5 feet). Ramps should be built to provide cyclists access to the bridge sidewalks; signs should be placed advising cyclists to walk their bikes on the sidewalk if it's too narrow for riding.

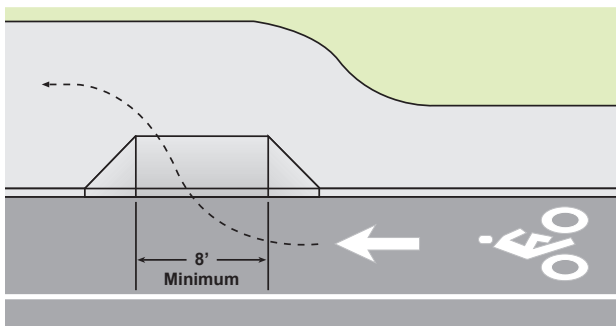

Figure 1-40: Ramp allows bicycle to access sidewalk on bridge

Extruded Curbs

These create an undesirable condition when used to separate motor vehicles from cyclists: cyclists may hit the curb, lose control and fall onto the roadway. At night, the curbs cast shadows on the lane, reducing the bicyclist's visibility of the surface. Extruded curbs are often hit by motor vehicles, causing them to break and scatter loose pieces onto the surface. They make bikeways difficult to maintain as debris accumulates.

Reflectors & Raised Pavement Markers

These can deflect a bicycle wheel, causing cyclists to lose control. If pavement markers are needed for motorists, they should be installed on the motorist's side of the stripe, and have a beveled front edge.

Two-way Bike Lane

This creates a dangerous condition for bicyclists. It encourages riding against traffic, causing several problems:

- At intersections and driveways, “wrong way” riders approach from a direction where they are not visible to motorists;
- Bicyclists closest to the motor vehicle lane have opposing motor vehicle traffic on one side and opposing bicycle traffic on the other; and
- Bicyclists are put into awkward positions when transitioning back to standard bikeways.

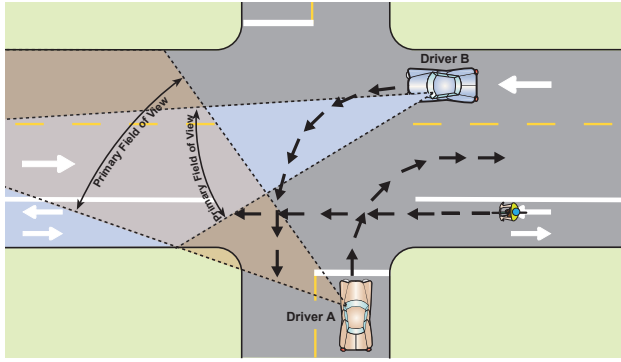

Right turning driver A is looking for traffic on the left; Left turning driver B is looking for traffic ahead; In both cases, a wrongway bicyclist is not in the drivers main field of vision.

Figure 1-41: Problems with two-way bike lanes

A two-way bike lane on one side of the road is sometimes proposed in areas where there is insufficient room for two minimum width bike lanes. If constraints allow widening on only one side of the road, the centerline stripe may be shifted to allow for adequate travel lanes and bike lanes on both sides.

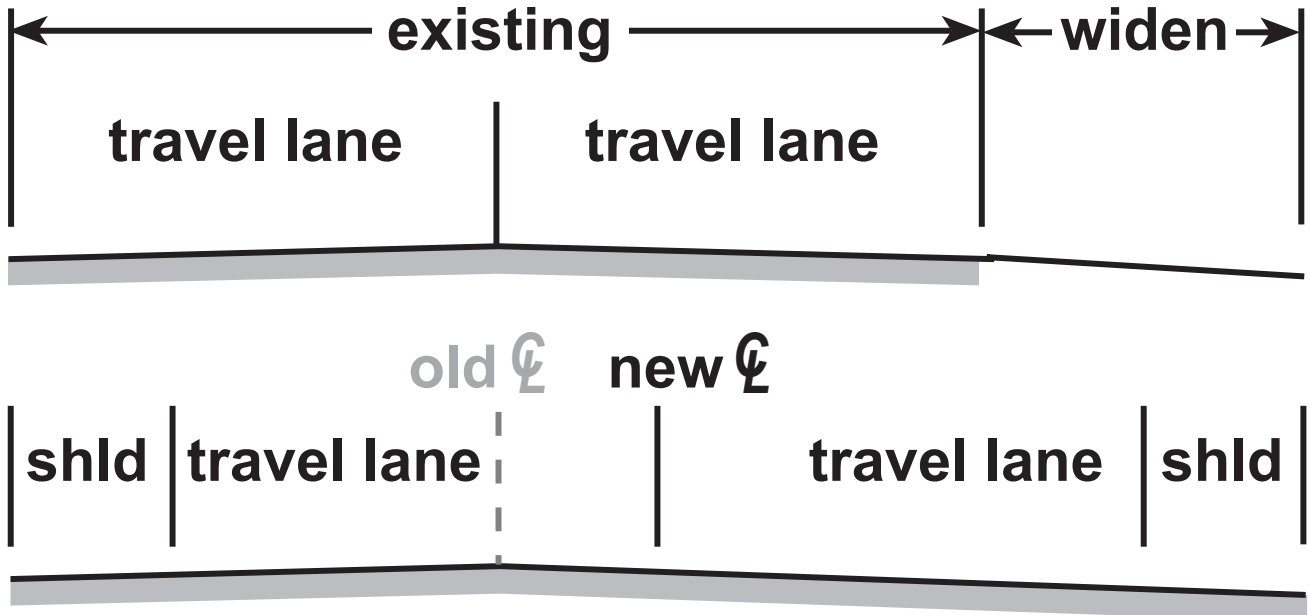

Figure 1-42: Widening one side and moving center line results in proper bike lane placement

Continuous Right-Turn Lanes

This configuration is difficult for cyclists: riding against the curb puts them in conflict with right-turning cars, but riding to the left of the continuous right-turn lane puts them in conflict with cars merging in and out of the right-turn lane.

Continuous right-turn lanes are rarely created intentionally; they happen as development occurs, and a deceleration lane is provided for

each new access. If the access points are too close together, the deceleration lanes merge into one continuous lane. The best solution is to implement an access management strategy to consolidate accesses and add short deceleration lanes only where warranted. Then a continuous through bike lane can be striped to the left of the deceleration lanes.

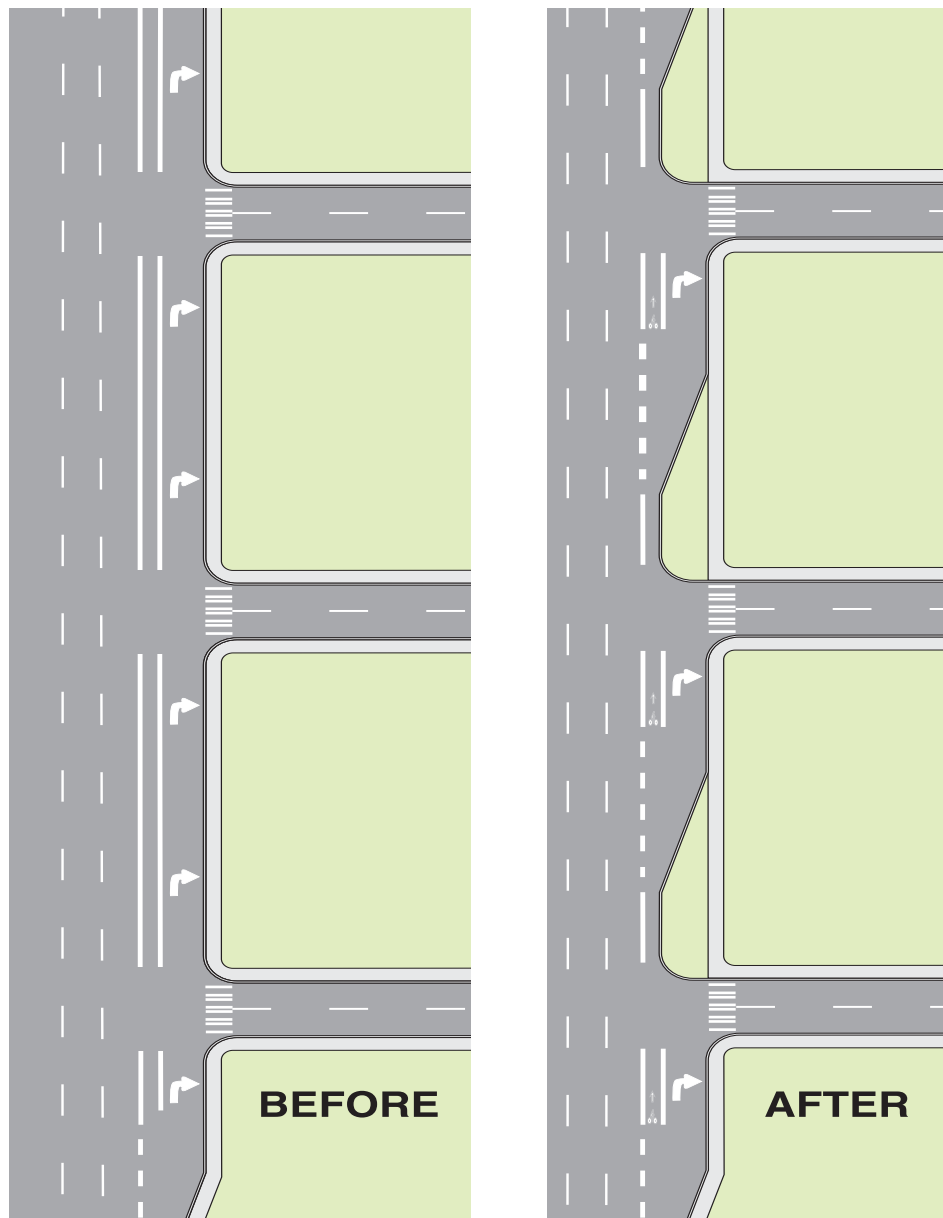
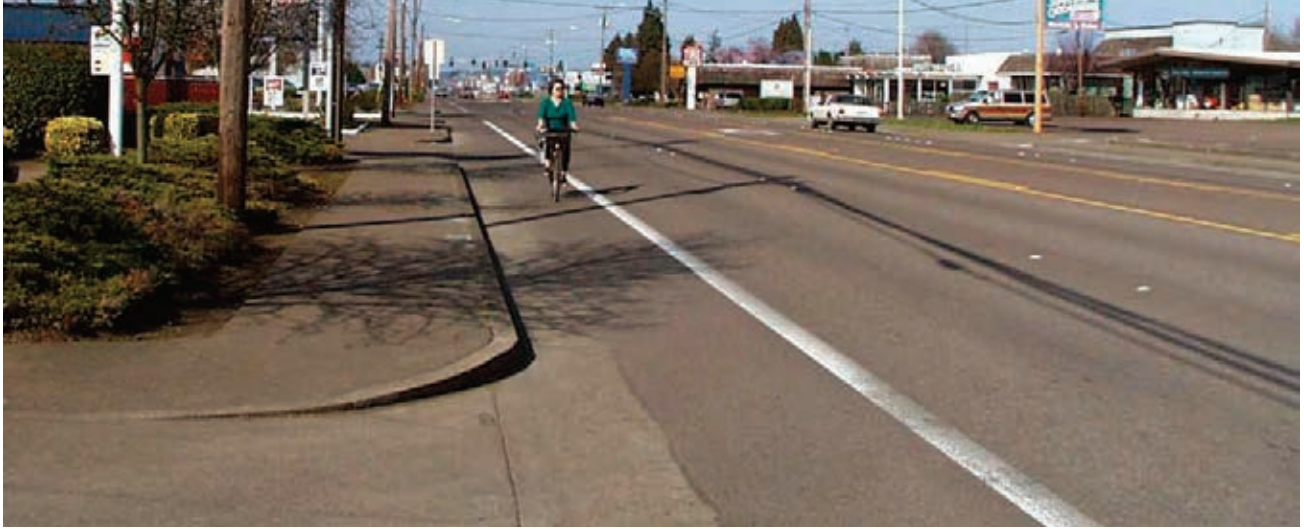

Figure 1-43: Continuous right turn lane reconfigured

CHAPTER 2: RESTRIPING ROADS WITH BIKE LANES (ROAD DIETS)



Bike lane restriped by narrowing travel lanes on commercial arterial

Introduction

Bike lanes generally serve bicyclists and motorists well on busy roadways in urban areas, but many urban roadways were built without bike lanes and often act as deterrents to bicycle travel. Bike lanes can be retrofitted onto existing urban roadways by:

1. Marking and signing existing shoulders as bike lanes;
2. Widening the roadway to add bike lanes; and
3. Restriping the existing roadway to add bike lanes.

In many cases, altering the existing curb-to-curb width is costly or impractical. Restriping the roadway to add bike lanes is a practical approach. Restriping existing roadways is often referred to as a “road diet.” Restriping has benefits for all users, not just cyclists.

These guidelines illustrate how a roadway can be restriped for bike lanes, without negatively affecting and often enhancing the safety and operation of the roadway. Sample travel

lane widths are within acceptable ODOT & AASHTO minimums. In ODOT designated Special Transportation Districts and other urban settings where speeds are lower, the need for wide travel lanes decreases.

It is important to use good judgment, and to consider context. Each project should be approved by a traffic and/or roadway engineer to ensure that capacity and safety are not compromised. ORS 366.215 prohibits reducing capacity on certain freight routes. Exceptions to this statute are allowed if safety or access considerations require the reduction. An exception may also be granted by the Oregon Transportation Commission if it is in the best interest of the state and freight movement is not unreasonably impeded.

The examples given are not the only acceptable way to restripe a roadway. It is not always necessary to use dimensions in whole feet increments. For example, with 32 feet available, 10.5 feet travel lanes with 5.5 feet bike lanes may work better in some cases than 11 feet travel lanes with 5 feet bike lanes, or 10 feet travel lanes with 6 feet bike lanes.

Reduce Lane Widths

Narrow Travel Lanes

Commonly used lane widths are: 14 feet center turn lanes, 12 feet travel lanes, 6 feet bike lanes and 8 feet parking lanes; under many conditions these can be narrowed to:

- 25 MPH or less: lanes can be reduced to 10 feet or 11 feet.
- 30 to 40 MPH: 11 feet travel lanes and 12 feet center turn lanes are acceptable, even desirable.
- 45 MPH or greater: 12 feet outside travel lane and a 14 feet center turn lane if there are high truck volumes.

Dimensions should take into account the combination of speeds, volumes, trucks, context, and desired outcome. On state highways, the above dimensions may only be applied if a design exception is approved where HDM standards are not met.



5 lane roadway with wide lanes, no bike lanes



5 lane roadway with bike lanes, narrowed motor vehicle lanes

BEFORE:

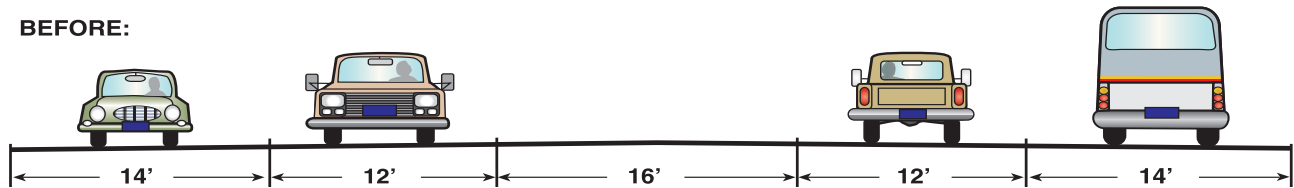

AFTER:

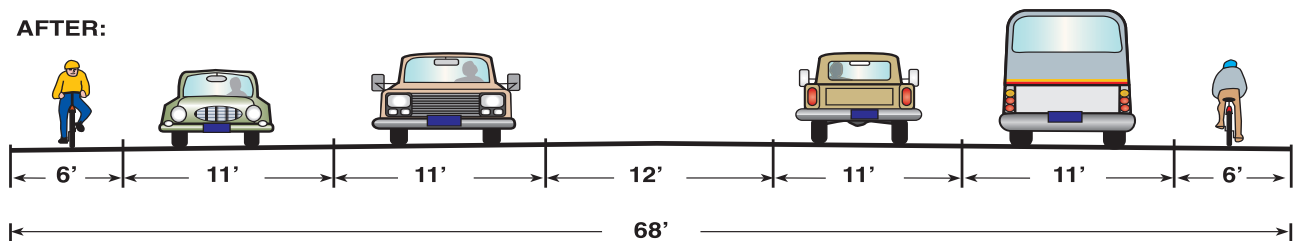

Figure 2-1: Bike lanes added by narrowing travel lanes

Modify Parking

Reduce on-street parking

On-street parking is usually beneficial to businesses and pedestrians. On-street parking helps keep traditional street-oriented businesses viable, provides a buffer for pedestrians, and helps keep traffic speeds down. Removing parking for bike lanes requires careful

negotiation with the affected businesses and residents. Before making a proposal, a parking study should be conducted that includes:

- Counting the number of businesses/residences and the availability of both on-street and off-street parking;
- Estimating use and occupancy characteristics;

- Selecting which side would be less affected by removal (usually the side with fewer residences or businesses);
- Replacing on-street parking with parking bays for residents or businesses with no other options;
- Proposing parking management strategies that increase the supply of parking when and where it's most needed, such as:
 - Allowing parking for church or school activities on adjacent lots during services or special events;
 - Shared use by businesses and institutions, or
 - Prohibiting on-street parking by employees;
- Evaluating crossing conditions for pedestrians.

The fear of losing potential customers is an important reason to retain on-street parking. Many cities have ordinances prohibiting employees from parking on the street. This increases the number of available parking spaces for customers, even if the total number of parking spaces is reduced. One parking place occupied by an employee for eight hours is the equivalent of 16 customers parking for half an hour, or 32 customers parking for 15 minutes, etc.

Remove Parking on One Side

On most streets with parking on both sides, removal of all on-street parking is not necessary: removing parking from one side creates enough space for two bike lanes, with some additional lane narrowing. Parking may be needed on only one side to accommodate residences and/or businesses with no off-street parking.

Notes:

1. It is not always necessary to retain parking on the same side of the road through an entire corridor.
2. Education and enforcement may be needed for a period of time after parking has been removed in the space dedicated to a bike lane, to prevent motorists from parking in the new bike lanes.

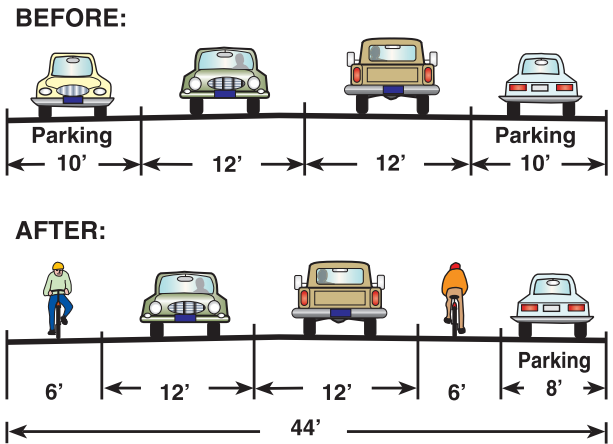

Figure 2-2: Parking removed from one side



Parking removed from one side to add bike lane

Change From Diagonal to Parallel Parking

Changing to parallel parking on one side only is usually sufficient; this reduces total parking availability of a street segment by less than one-fourth.

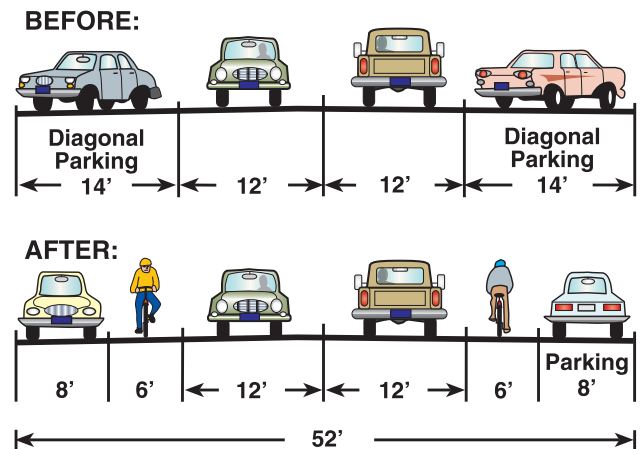
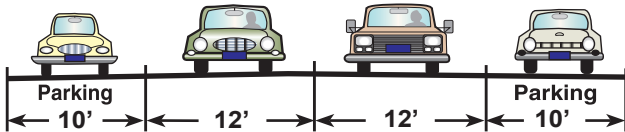

Figure 2-3: Restripe from diagonal to parallel parking

Narrow Parking Lanes

Parking can be narrowed to 7 feet, particularly in areas with low truck parking volumes. On a one-way street, only one bike lane needs to be provided, so narrowing both parking lanes a little bit creates enough room for one bike lane.

BEFORE:



AFTER:

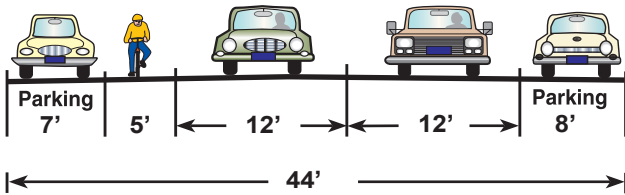

Figure 2-4: Bike lane added by narrowing parking



Bike lanes added by narrowing parking lane

Replacing Lost Parking

Where all of the above possibilities have been pursued, and residential or business parking losses cannot be sustained, innovative ideas should be considered to provide parking, such as:

- Increasing parking supply on side streets; or
- Creating parking bays by using a portion of a planting strip, where available.

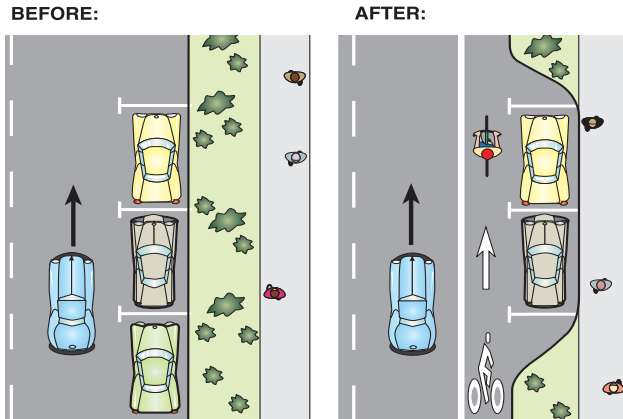

Figure 2-5: Parking bays



Parking bay

Road Diets: Reduced Number Of Travel Lanes

Many roads were built wider than needed to accommodate existing or projected traffic volumes, or traffic conditions have changed since the road was built, and the number of travel lanes can be reduced. This concept is generally referred to as a “road diet.” In most cases the road diet results in enough space to stripe bike lanes. This chapter focuses on road diets and bike lanes, but road diets have safety, operational and livability benefits for motorists and pedestrians.

In all cases a traffic study must be conducted to ensure the resulting roadway will carry the traffic at an acceptable level of service. In many cases the road carries as much traffic with fewer lanes, and performs better when one considers issues that concern residents, business owners, bicyclists, pedestrians and others who use the roadway for a variety of reasons.

The most common road diet takes a 4-lane undivided highway and redistributes the roadway to one travel lane in each direction, a center turn lane and two bike lanes. The safety benefits of the 4 to 3 lane road diet include:

- Fewer rear-end crashes: motorists wait to make a left turn in a dedicated turn lane, not in a through lane;
- Fewer sideswipe crashes: motorists no longer swerve around a vehicle waiting to turn left in a through lane;
- Fewer left turn crashes: turning motorists face only one lane of oncoming traffic;
- Reduced speeds;
- Easier and safer pedestrian crossings, especially with a median island in the center turn lane: pedestrians cross only one lane at a time instead of all 4 lanes at once; and
- Elimination of multiple threat crash.

Operational benefits of the 4 to 3 lane road diet include:

- Fewer delays from traffic stacked behind a car waiting to turn left;
- Easier to negotiate right turns, as the curb lane is offset from the curb; and
- Higher carrying capacity where many left turns obstruct the inside lane on a 4-lane section.

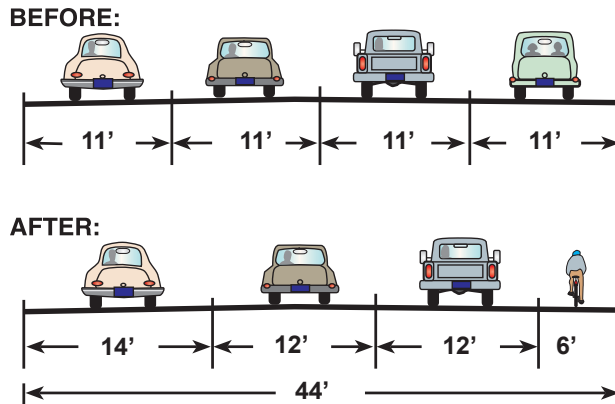

Figure 2-6: Road Diet – 4 motor vehicle lanes becomes 2 bike lanes and 3 motor vehicle lanes



4 lane undivided roadway



Restriped with bike lanes center turn lane and pedestrian crossing

The livability benefits of a road diet include:

- Greater separation from moving traffic for pedestrians;
- Room for street furniture and landscaping; and
- More people using bicycles for transportation.



Road diet created room for median pedestrian refuge island

One-way couplets

One-way couplets are good lane-reduction candidates if they have more travel lanes in one direction than necessary for the traffic

volumes. For example, a 4-lane one-way street can be reduced to 3 lanes and a bike lane. Since only one bike lane is needed on a one-way street, removing a travel lane can free up enough room for other features such as on-street parking or wider sidewalks. Both legs of a couplet must be treated equally, so there is a bike lane in each direction.

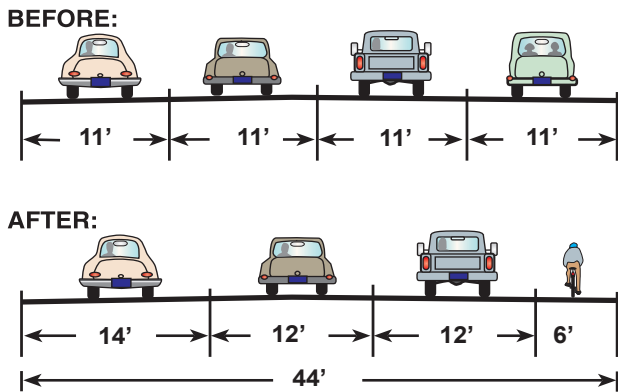

Figure 2-7: Motor vehicle travel lane removed from 4-lane, one way street



Removing a travel lane created room for a bike lane, curb extension and on street parking

Unbalanced Flow

On streets with higher traffic volumes in one direction than the other, one direction of travel can have one less travel lane than the other side. For example, a 4-lane undivided roadway can be restriped with 2 lanes in one direction, one lane in the other, and 2 bike lanes.

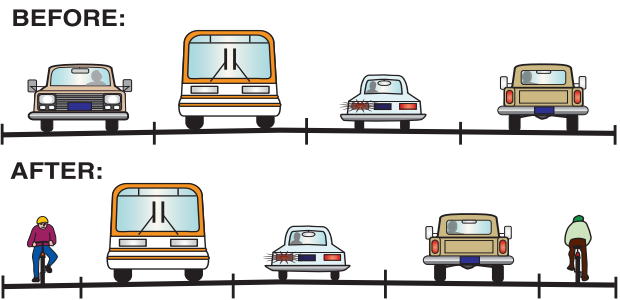

Figure 2-8: 4-lane, two way street restriped with 2 lanes in one direction, 1 in the other and bike lanes

Pavement Conditions

Restriping a roadway with bike lanes will encourage more people to ride their bikes there; the expectation of a good riding experience must be met, and part of that experience is a good riding surface. If this expectation is not met, unsafe conditions and frustration can lead to opposition to more bike lanes. Improvements at the outer edge of the roadway should be made prior to bike lane restriping, including:

- Ensuring the surface is smooth and in good condition;
- Raising existing drainage grates, manhole and utility covers flush to the pavement; and
- Removing or relocating obstructions away from the edge of roadway to gain some useable width. Obstructions can include guardrail, utility poles and sign posts.

The best time to restripe a roadway is after a pavement overlay project, for two reasons:

- The new pavement offers a blank template; and
- Obliterating existing striping creates problems: the old stripes can show up on rainy days or at night when cars have their headlights on. Grinding out old lane lines can leave grooves deep enough to be a hazard to cyclists.



Bike lanes striped on new pavement show up well

Width Constraints

Not all existing roadways allow bike lanes to be retrofitted for an entire corridor. Unique and creative solutions will have to be found to ensure bikeway continuity in constrained areas:

- Width restrictions may only allow for a wide curb lane to accommodate bicycles and motor vehicles.
- Where no possible extra width is obtainable, another technique is to slow traffic speeds so shared roadway conditions are acceptable.
- If the constraint is more than a few blocks, an alternate route may have to be improved for cycling; the alternate route must provide access to the destinations served by the thoroughfare considered for restriping.

Bike lanes must resume where the restriction ends. It is important that every effort be made to ensure bike lane continuity. Practices such as directing bicyclists onto sidewalks or other unsuitable streets should be avoided, as they may introduce unsafe conditions.

Additional Benefits

Restriping roadways for bike lanes has benefits over and beyond those for bicyclists. Drivers and pedestrians also benefit when motor vehicle travel lanes are moved away from the curb:

Benefits for motorists include:

- Extended pavement life, as traffic is no longer driving in the same well-worn ruts.

- Safety, as travel lanes are offset from curbs, and lanes are better defined, which can improve sight distance and increase the effective turning radius at intersections and driveways. See discussion on road diets for safety benefits of reducing the number of motor vehicle travel lanes.

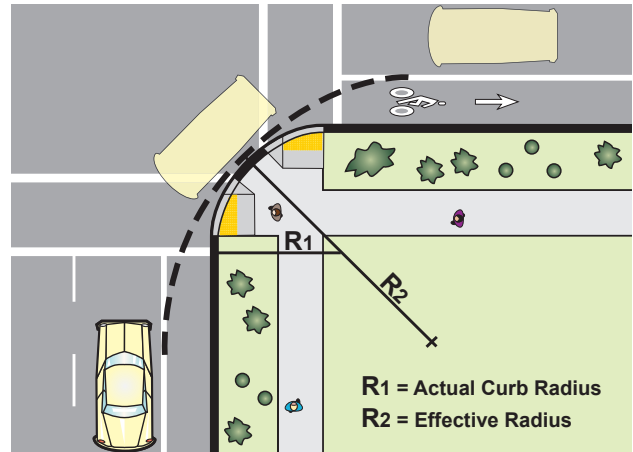

Figure 2-9: Motor vehicle travel lane offset by bike lane results in larger effective turn radius

BEFORE:



AFTER:

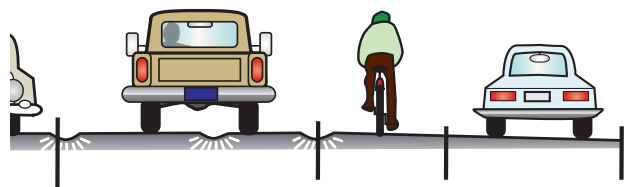

Figure 2-10: Restriping offsets travel lanes reducing wear and tear

Benefits for pedestrians include:

- Greater separation from traffic in the absence of on-street parking or a planter strip, increasing comfort and safety. This is important to young children walking, playing or riding their bikes on curbside sidewalks.

- An area for people in wheelchairs to travel where there are no sidewalks, or where sidewalks are in poor repair or do not meet ADA standards.
- Reduced splash from vehicles driving through puddles; in dry climates, less dust raised by passing vehicles, as they drive further from unpaved surfaces.
- The possibility of planting street trees, as the roots are not immediately under travel lanes.

Bike Lane Widths

The standard width for a bike lane is 6 feet. While it is important to maintain standards for bicycle facilities, there may be circumstances where restrictions don't allow full standards.

Minimum bike lane widths are:

- 5 feet against a curb or adjacent to a parking lane. A 4.5 foot curbed bike lane may be allowable where there are very severe physical constraints.
- 4 feet on uncurbed shoulders.



Bike lane provides minimal buffer for pedestrians

CHAPTER 3: BICYCLE PARKING



Well placed bicycle parking

Introduction

Secure bicycle parking provided at likely destinations is an integral part of a bikeway network. Bicycle thefts are common and lack of secure parking is often cited as a reason people hesitate to ride a bicycle to certain destinations. The same consideration should be given to bicyclists as to motorists, who expect convenient and secure parking at all destinations. Bicycle racks must be designed so that they:

- Don't bend wheels or damage other bicycle parts;
- Accommodate high security U-shaped bike locks;
- Allow users to secure the frame and both wheels;
- Don't obstruct pedestrians (especially when bikes are parked);
- Are covered where users will leave their bikes for a long time; and
- Are easily accessed from the street and protected from motor vehicles.

The simplest, easiest to install and most effective bike rack is the “inverted U” or “staple.” Both fulfill all of the above design requirements.

To establish a theme or motif, “art racks” are often created to add whimsical and artistic touches to otherwise perfunctory bike racks. In many cases they function well for bike parking, and don't interfere with pedestrian travel. But some racks have features that make it difficult to lock a bicycle securely, or protrude too far into the pedestrian's path of travel. The best art racks are variations of the commonly accepted inverted U or staple designs.



Upside down U or staple rack accommodates two bicycles

Bicycle parking facilities are generally grouped into 2 classes:

- **Long Term:** Provides complete security and protection from weather. It is intended for situations where the bicycle is left unattended for long periods of time: apartments, condominiums, schools, places of employment and transit stops. These are usually lockers, cages or rooms in buildings, providing real security for the bicycle (with its easily removed components) and accessories (lights, pump, tools and bags).
- **Short Term:** Provides a means of locking the bicycle frame and at least the front wheel, but does not provide security for accessories, or weather protection unless covered. It is for parking where the bicycle is left for a short period of time and is visible and convenient to the building entrance.

The following recommendations are presented to help cities and counties develop local bicycle parking ordinances.



Bike racks can be street art

Recommended Standards

Dimensions

The recommended dimensions ensure that bicycles can be securely locked without undue inconvenience and will be reasonably safeguarded from theft as well as intentional or accidental damage.

- Bicycle parking spaces should be at least 6 feet long and 3 feet wide, and overhead clearance in covered spaces should be at least 7 feet.

- A 6 feet aisle for bicycle maneuvering should be provided and maintained beside or between each row of bicycle parking.
- Bicycle racks or lockers should be securely anchored to the surface or a structure.

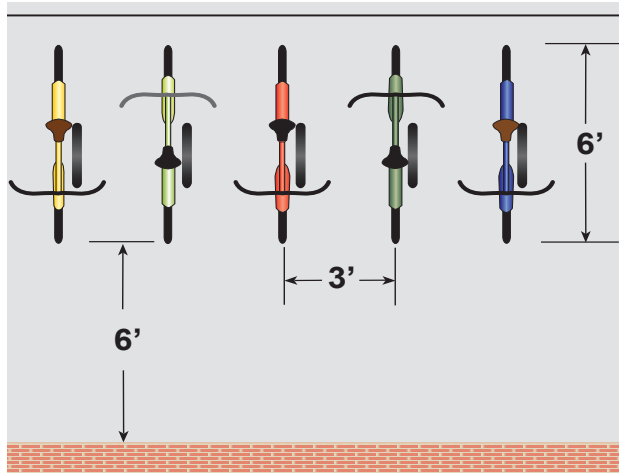

Figure 3-1: Recommended bicycle parking dimensions

Covered Parking

Pacific Northwest winters have mild temperatures and periods of intermittent rain. Many short trips can be made by bicycle without getting wet; however, a rider might hesitate to leave a bicycle exposed to the weather if it's left unattended for a long time.

Covered parking is necessary for long-term parking (mostly residential and employee uses). For customers, visitors and other occasional users, covered parking is also beneficial. Covered spaces can be roof overhangs, awnings, lockers or bicycle storage spaces within buildings.

Covered parking needs to be visible for security, unless supplied as storage within a building. Covering should extend 2 feet beyond the parking area, to prevent cross-winds from blowing rain onto bicycles.

- Bicycle parking for residential, school and industrial uses should be covered.
- 50% of bicycle parking for commercial uses should be covered.

- Where motor vehicle parking is covered, bicycle parking should also be covered.

Where there are 10 or more bicycle parking spaces, at least 50% of the bicycle parking spaces should be covered.



Covered bike parking

Location

Bicycle parking should be located in well lit, secure locations within 50 feet of the main entrance to a building, but not further from the entrance than the closest automobile parking space; and in no case further than 50 feet from an entrance where several entrances are involved.

The effectiveness of bicycle parking is often determined by location. To reduce theft, a highly visible location with much pedestrian traffic is preferable to obscure and dark corners, even if the more visible location is more distant. Because of its smaller size, the bicycle can be parked closer to the rider's destination than a car.

Racks near entrances should be located so there are no conflicts with pedestrians. Curb cuts near the rack location discourage users from riding on the sidewalk to access the racks.

Many sites need two types of bicycle parking: short-term for customers (up front); and long-term (covered) for employees, which may be placed further away from the main entrance.

Separating bicycle from car parking by a physical barrier or sufficient space protects bicycles from damage by cars.

Bicycle parking provided in the public right-of-way should allow sufficient passage for pedestrians (6 feet).



Bike racks placed out of pedestrian zone

(Bicycle parking may be provided within the public right-of-way in areas without building setbacks, subject to approval of local officials and provided it meets the other requirements for bicycle parking.)

In Central Business Districts, simple racks placed along the sidewalks serve bicyclists riding to various locations along a commercial street. They should be placed in the furniture or the frontage zone, so they do not interfere with pedestrians. There should be several per block: smaller bicycle parking areas are preferable to one large centralized area both for convenience in access and greater security.

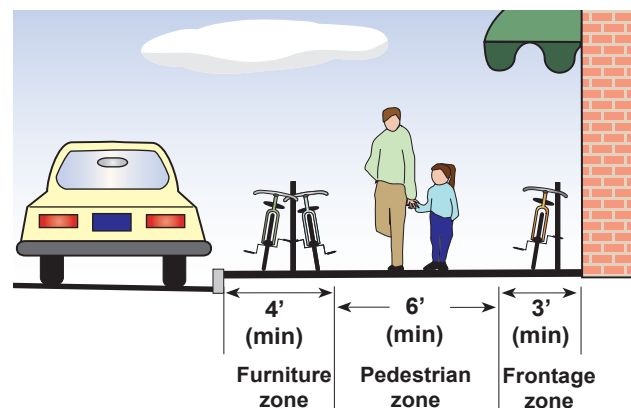

Figure 2-2: Bike parking in furniture zone in central business district



Covered bike parking on curb extension

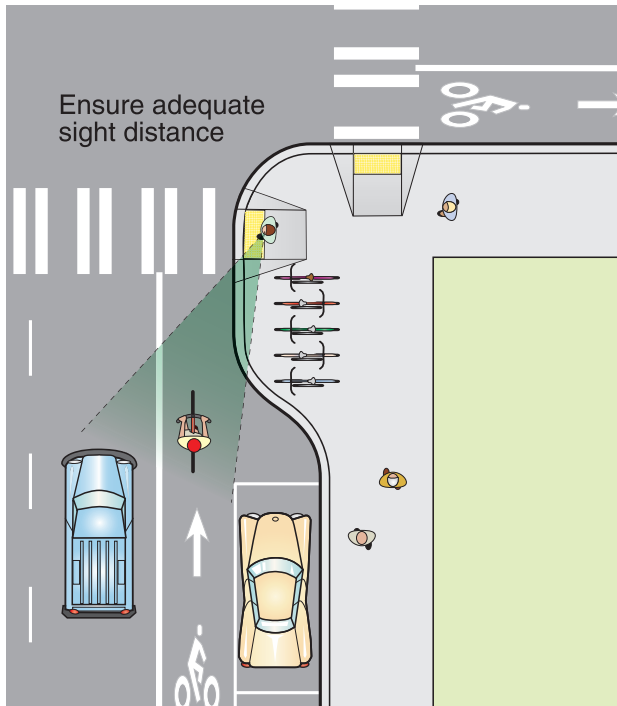

Figure 3-3: Bike parking on curb extension

Bicycle parking on curb extensions

Curb extensions create good opportunities to provide bicycle parking out of the pedestrian zone, especially in areas where sidewalks are narrow. They also benefit from the proximity of a curb cut at the corners. The parking should be placed where it will not obscure visibility of pedestrians crossing the street, or motorists waiting to enter a street.

On-street bicycle parking

Where there is insufficient room on the sidewalks to provide sufficient bicycle parking without cluttering the pedestrian zone, bicycle parking can be provided in the street. One parallel car parking spot can provide parking for up to 12 bicycles. It must be buffered by bollards, curb extensions or other forms of positive protection.

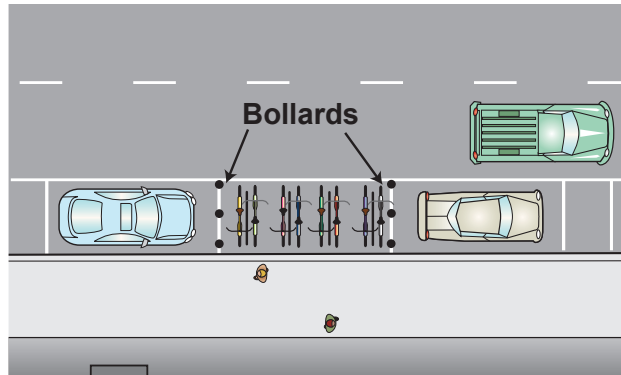

Figure 3-4: Protected on street bike corral



On-street bike parking

Bicycle parking may also be provided inside a building in secure and accessible locations. This provides a high degree of security and protection, at the expense of some convenience. Dedicated rooms with card locks are very effective. Locating a room close to changing and showering facilities enhances its attractiveness.

Number of Spaces

See Table 3.3.400 in the model land use and development codes developed by the Transportation and Growth Management program: <http://www.oregon.gov/LCD/TGM/docs/modelCode05/pdf/art3.pdf>. The TGM recommendations are based on specific and easily measurable criteria; e.g. size of buildings, number of residential units, number of classrooms, etc.

Combined parking could be allowed in areas of concentrated small businesses, such as downtowns and business parks. Publicly provided bicycle parking could also be used.

For park-and-ride lots, requirements need to relate the number of bicycle parking spaces to the probable service area (e.g. the number of residents within a three-mile radius of a facility.)



Secure bicycle parking in basement room

The amount, location and usage of bicycle parking should be monitored and adjusted to ensure that there is an adequate supply. If bicycle use increases, the need for bicycle

parking may increase above that specified when facilities are constructed. Local jurisdictions may have to require additional bicycle parking to meet the demand.

Employment and retail centers should voluntarily provide additional parking to satisfy the demands of customers and employees.

Signing

Directional signs are needed to guide cyclists if the bicycle parking locations are not visible from building entrances or transit stops. Instructional signs may be needed if the design of bicycle racks isn't readily recognized as bike parking, such as art racks.

But for security reasons, it's better not to sign long-term employee parking within a building, to avoid bringing bicycles to the attention of potential thieves.

Other Recommendations

Long-term bicycle parking spaces should be provided at no cost, or with only a nominal charge for key deposits, etc. Residential parking spaces should be available to residents as part of rental or ownership contracts. This does not preclude the operation of private for-profit bicycle parking businesses.

Short-term bicycle parking should be available near the building entrances of all land uses, and should be free.

CHAPTER 4: WALKWAYS



A successful Central Business District depends on good sidewalks

Types of Walkways

Pedestrian facilities include sidewalks, traffic signals, crosswalks, refuge islands, pedestrian-scale illumination and benches. Walkways include:

- **SIDEWALKS**, located along roadways, separated with a curb and/or planting strip or swale, have a hard, smooth surface. Sidewalks in residential areas are sometimes used by bicyclists, but cities may ban bicycle riding on sidewalks.



Sidewalks serve pedestrians in urban and suburb contexts

- **PATHS**, typically used by pedestrians, cyclists, skaters and joggers (shared-use). It is not realistic to plan and design a path for exclusive pedestrian use, as others will be attracted to the facility. Paths may be unpaved (packed gravel) if they are smooth and firm enough to meet ADA requirements. See Chapter 7 for path design guidelines.



Paths serve pedestrians in many contexts

- **SHOULDERS**, which serve pedestrians in many rural areas. The ODOT-recommended shoulder widths are usually adequate to accommodate pedestrians. In rural areas where population densities are too low to justify sidewalks, shoulders should be:

- Wide enough (6 feet) to accommodate pedestrian and bicycle traffic.

See shoulder width table in Chapter 1 for shoulder width guidelines.



Shoulders serve pedestrians in rural areas

Standards

Sidewalks

The Sidewalk Zone System

The best way to achieve the goal of a clear walking area is to design sidewalks using the zone system. Each zone is a distinct sidewalk area; the 4 zones are:

1. The curb zone;
2. The furniture (or planter) zone;
3. The pedestrian (or walking) zone; and
4. The frontage zone.

Each zone has its function, and omitting a zone compromises the quality of the walking experience. The zone system makes it easier to meet the basic ADA requirements for a continuous, smooth, level sidewalk free of obstructions. It's easier to keep the sidewalk level across driveways, place ramps correctly, and all potential obstructions (poles, signs, trees, drinking fountains, benches, etc.) can be placed in the furniture or frontage zones. Separation from the roadway also places pedestrians further from traffic, increasing comfort and security.

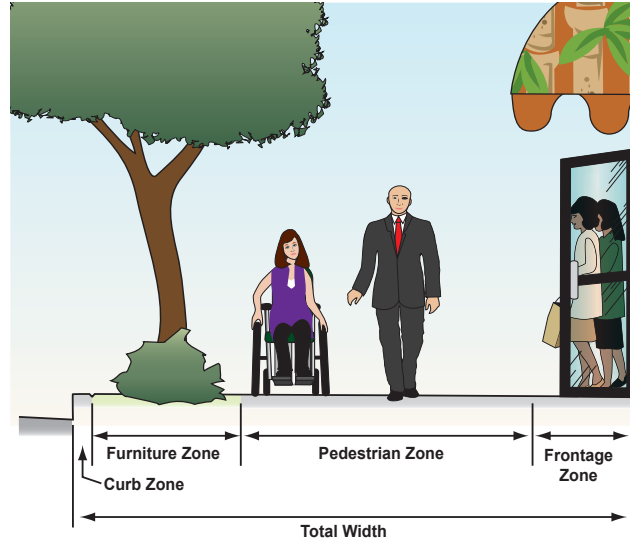

Figure 4-1: The sidewalk zone system, urban context

The Curb Zone:

Most urban streets with sidewalks are typically curbed. A vertical (barrier) curb channelizes drainage and prevents people from parking their cars on the sidewalk. Mountable curbs are not recommended on urban streets, as they make it easier for drivers to park on the sidewalk. The curb zone is also where a sidewalk transitions to the street at a crosswalk or intersection; the design of the gutter pan (apron) is critical for ADA access standards.

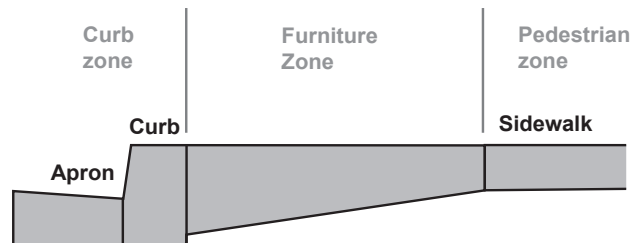

Figure 4-2: The curb zones transitions from the street to the sidewalk

The Furniture Zone:

The furniture zone is located between the curb and pedestrian zones and can be paved or landscaped. When landscaped it is referred to as the furniture zone. It's easier to meet ADA sidewalk requirements with separated sidewalks. The furniture zone has many functions:

- Pedestrians are separated from traffic, increasing a walker's sense of security and comfort;
- Street furniture and obstructions (bicycle parking, poles, posts, mailboxes, parking meters, fire hydrants, etc.) can be placed out of the walking zone (these objects should not reduce visibility of pedestrians, bicyclists and signs);
- Room for street trees and other landscaping (plants should be selected that require little maintenance and watering; roots should not buckle sidewalks);
- The sidewalk can stay level across driveways;
- Ramps can be placed correctly: sidewalks, curb cuts and crosswalks line up at intersections;
- Improved drainage: decreased runoff water, decreasing overall drainage requirements; prevents water in puddles from splashing onto pedestrians; creates a place to store snow removal during the winter.

The curb zone and furniture zone should be 5 feet wide or more. Narrower furniture zones (2 feet min) offer some of the advantages listed above. Where constraints preclude the use of the same width throughout a project, the furniture zone can be interrupted and resumed where the constraint ends.

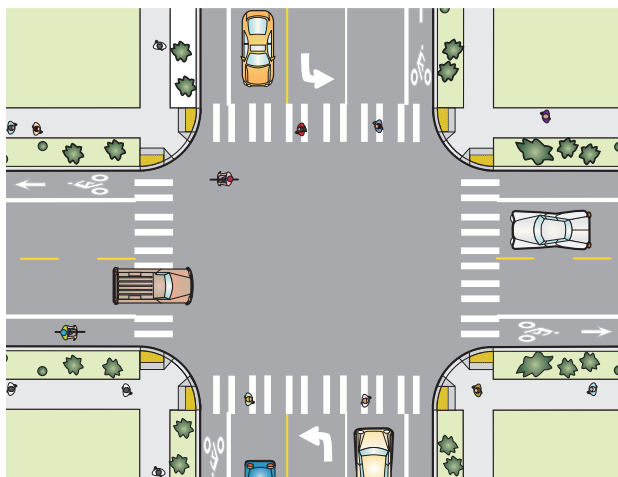

Figure 4-3: Separated sidewalks facilitate ramp and crosswalk alignment



A well organized furniture zone leaves the pedestrian zone clear of obstacles

The Pedestrian Zone:

This is where people walk. All planning, design and construction documents should clearly state the walking zone dimension is to be clear of all obstructions. The ODOT standard pedestrian zone width is 6 feet. This width allows two people (including wheelchair users) to walk side by side, or to pass each other comfortably. It also allows two pedestrians to pass a third person without leaving the sidewalk. Where it can be justified and deemed appropriate, the minimum width may be 5 feet, such as on local streets, with adequate separation from the roadway. At no point should the pedestrian zone be less than 4 feet wide at pinch points such as around poles.

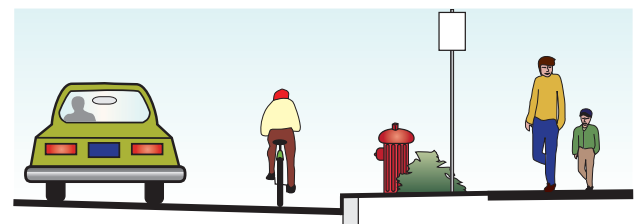

Figure 4-4: Separated sidewalk is free of obstructions

Clearance to vertical obstructions (signs, tree limbs, etc.) must be at least 7 feet.



5 foot sidewalk is uncomfortably narrow



Sidewalk widened to 6 feet

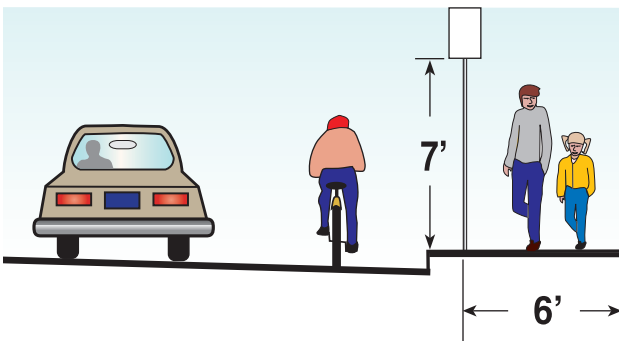

Figure 4-5: Sidewalk clearances

The pedestrian zone should be straight, or parallel to the adjacent road when the road naturally curves. Attempts to create meandering sidewalks usually fail because they do not serve the needs of pedestrians, who want to walk in the most direct route possible. The only exceptions should be when a sidewalk is

substantially separated from a roadway, and the natural contours of the pedestrian zone are different from the alignment of the roadway, or to avoid large obstacles such as mature trees, or other pinch points. Care must be taken to insure the pedestrian zone is free of obstructions.



Figure 4-6: The furniture zone may be eliminated or reduced at pinch points



Furniture zone eliminated at pinch point

Cars parked perpendicular or diagonally to sidewalks can reduce the sidewalk width if there is excessive overhang. Wheel stops should be used to prevent narrowing the usable sidewalk width.

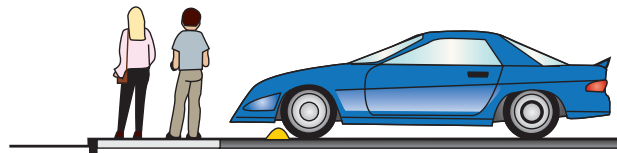

Figure 4-7: Wheel stops reduce sidewalk encroachment



Wheel stops prevent sidewalk encroachment

Sidewalks must not be placed directly adjacent to a high-speed travel lane (45 MPH and above); they should be buffered with a planting strip, a parking lane or a bike lane. In the absence of any separation, sidewalks next to high-speed roadways should be at least 8 feet wide, as the outer two feet are used for poles, sign posts, etc. This results in an effective 6 feet wide walking space and provides 2 feet shy distance from high speed motor vehicle traffic.

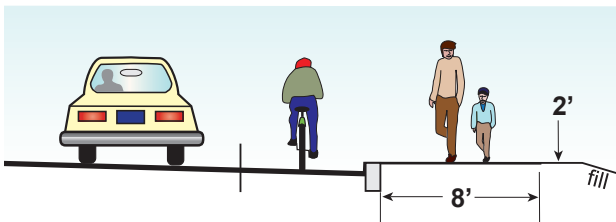

Figure 4-8: Recommended curb side sidewalk dimensions



Sidewalk with no buffer

Greater sidewalk widths are needed in high pedestrian use areas, such as central business districts, where 10 feet is considered necessary, as the sidewalks are often also used for sidewalk cafés, street furniture, etc. 12 feet to 14 feet sidewalks or greater are common in Central Business Districts.

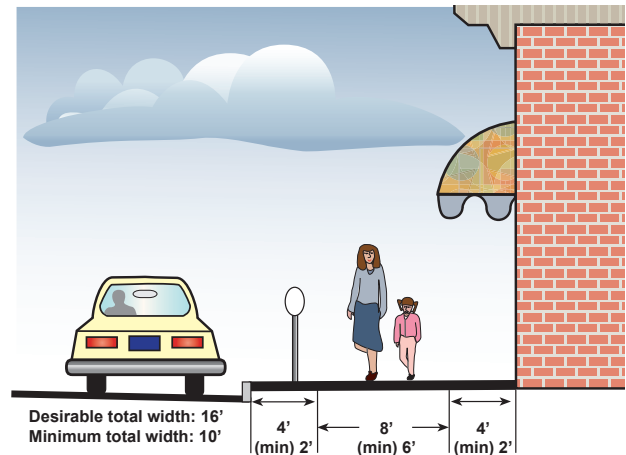

Figure 4-9: Recommended Central Business District sidewalk dimensions



Central business districts require wider sidewalks

The surface should be smooth and uniform. When a sidewalk is paved out to the curb, it is beneficial to make a surface distinction between the walking area and the buffer strip; this helps ensure obstacles are placed out of the walking area.

The Frontage Zone:

The frontage zone is located between the pedestrian zone and the right-of-way. It is where sandwich boards, bike racks and other street furniture are placed; it is used by window shoppers, it's where people enter and exit buildings.



A generous frontage zone with seating and bus shelter

The recommended width is 2 feet or greater. An absolute minimum of 1 foot is needed for practical purposes, for example to ensure that adjacent property owners don't erect a fence at the back of walk, or for maintenance personnel to make sidewalk repairs. A 2 foot shy distance is needed from vertical barriers such as buildings, sound walls, retaining walls and fences.

In Central Business Districts the frontage zone should be 4 feet or wider to provide space for merchandise, sidewalk cafés, and opening doors.

Note: ADA requires that "objects protruding from walls (e.g. signs, fixtures, telephones, canopies) with their leading edge between 27 inches and 80 inches above the finished sidewalk shall protrude no more than 4 inches into any portion of the public sidewalk." (ADAAG 14.2.2)



Frontage zone used for decorative planters

Sidewalks without Curb & Gutter

Most sidewalks are separated from the roadway with curbs, which channelize drainage and provide positive separation from traffic. But curb and gutter can add substantially to sidewalk costs. Where sidewalks are needed, but the high cost of curb and drainage cannot be justified, or where curbs don't fit the character of the street, sidewalks may be constructed without curb and drainage.

Sidewalks behind the ditch

On roads with a rural character, where drainage is provided with an open ditch, and where there is sufficient room, sidewalks may be placed behind the ditch.

The sidewalk should be built to the same width as curbed sidewalks: 6 feet (5 feet min). Gravel driveways should be paved 15 feet back from the sidewalk to avoid debris accumulation.

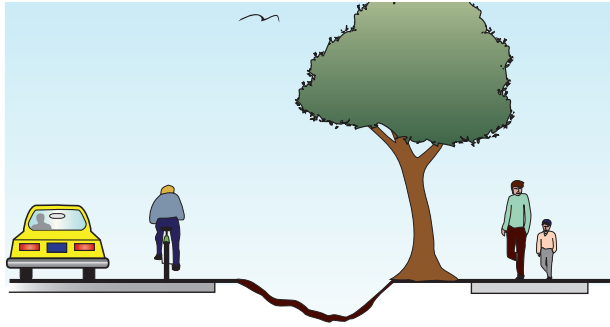

Figure 4-10: Sidewalk behind ditch or swale



Sidewalk behind swale



Barrier curb

Bridges

Sidewalks should always be provided on both sides of bridges where pedestrian use can be expected. The minimum width for sidewalks on bridges is 7 feet, to account for two shy distances: from traffic, and from the bridge rail, as some people feel uncomfortable walking close to a high vertical drop. Wider sidewalks should be considered in urban settings with high pedestrian use. The bridge sidewalk must not be narrower than the approach sidewalk. Sidewalks on bridges with design speeds greater than 40 MPH require a vehicle barrier at the curb line.

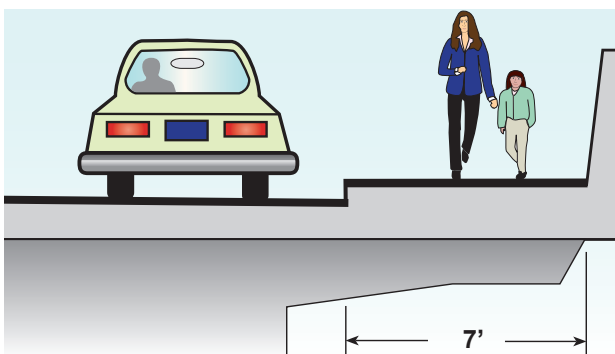

Figure 4-11: Minimum bridge sidewalk width

Surfacing

The preferred material for sidewalks is Portland Cement Concrete (PCC), which provides a smooth, durable finish that is easy to grade. Asphaltic Concrete (A/C) may be used if it can be finished to the same surface smoothness as PCC. A/C is susceptible to breakup by vegetation and has a shorter life expectancy than PCC.

Brick pavers can provide an aesthetically pleasing effect if the following concerns are addressed:

- They should be laid to a great degree of smoothness;
- They should not have beveled edges;
- The surface must be slip-resistant when wet; and
- Long-term maintenance costs should be considered.

Ornamental landscape pavers (often beveled or “pillowed”) should not be used as the primary walking surface; they can be used for aesthetics in the furniture and frontage zones. Sidewalk embellishments can also be achieved by treating concrete with dyes or with decorative scoring.



Pavers require regular maintenance to meet ADA requirements

Thickness

Sidewalks with foot traffic only are normally constructed with 4 inches of PCC on top of a compacted base of crushed rock or sand.

At driveways or where the sidewalk can be expected to be driven on by maintenance vehicles 6 inches of PCC is required. Heavy vehicle traffic, such as garbage trucks and emergency vehicles may require 8 inches of PCC to avoid damage.

Utility Vaults

Water meter covers, man holes and other utility vaults may be located within the pedestrian zone as long as they are smooth, slip resistant and do not have protruding hardware.

Tree Well Grates

Likewise tree well grates traversable by wheelchairs can be located within the pedestrian zone; however, tree well grates are a hazard to high heel wearers so care should be taken to minimize the extent that tree well grates extend into the pedestrian zone.



Wheelchair traversable tree grates may extend into pedestrian zone

Pedestrian Rail

Pedestrian rail should be provided where the sidewalk abuts a steep slope or hazard. The need for pedestrian rail can be eliminated with a shallow slope and soft surface, such as grass.

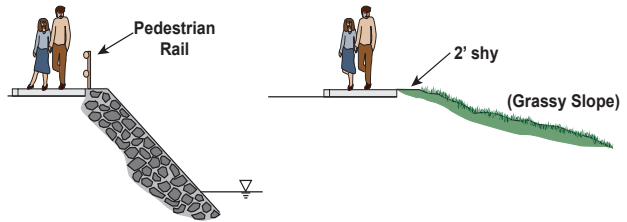

Figure 4-12: Pedestrian rail should be used when a sidewalk abuts a serious hazard

Pervious sidewalk surfaces

The concern over adding more impervious surfaces has led to the creation of a variety of permeable surface materials: pervious concrete and asphalt, pavers, and other innovative designs. The sidewalks are usually separated from the roadway with a bio-swale. This technology is evolving, and long-term maintenance is a concern. The concrete mix design is of particular importance, to avoid the “rice crispy” result. If used, pervious sidewalks surfaces must still meet smoothness standards: no more than ¼ inch height difference (ADA).

Sidewalks built out of conventional impervious materials (concrete) contribute little to runoff if they are separated from the roadway with a furniture zone: most of the precipitation that lands on the sidewalk can be absorbed by the native soil in the furniture zone.

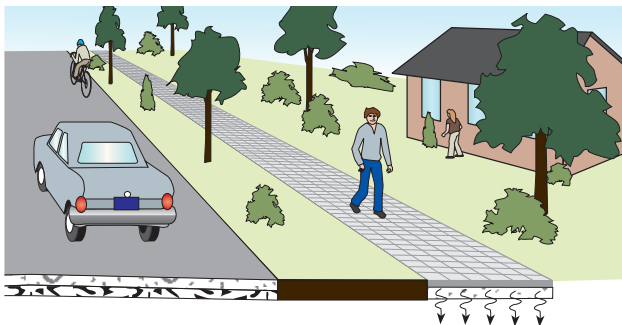

Figure 4-13: Pervious sidewalk



Concrete mix design is critical in pervious sidewalk to avoid a rough surface

Railroad Crossings

Sidewalks crossing a railroad are not controlled by the warning gates/arms; they cross behind the gate/arm. The sidewalk width across the tracks should be the same as the approaching sidewalk, or wider.

OAR 741-120-0025 (3) states: “At crossings equipped with automatic protective devices, sidewalks shall be directed behind the devices at a distance of not less than 5 feet, as measured from the centerline of the signal mast to the nearest edge of the sidewalk.” Sidewalks at crossings equipped with automatic protective devices should be constructed as close to the roadway as possible so that users receive visual and auditory warnings of approaching trains. To this end, the far edge of the sidewalk should be no more than 10-12 feet from the centerline of the signal mast.

There is no mandate for sidewalks to cross tracks at 90°. When a sidewalk crosses tracks at a skew, it’s usually possible for people in wheelchairs to align themselves at a right angle within the width of a 6 foot sidewalk, even in most cases within a 5 foot sidewalk. Some people prefer to cross at a slight angle, so both casters don’t hit the tracks at the same time. For this reason, the best practice is to widen the sidewalk at the grade crossing to allow the 4 foot

square footprint of a wheelchair to align itself to cross tracks safely, regardless of the skew angle at the crossing. Curving the entire sidewalk to cross tracks at 90° is usually unnecessary.

Detectable warnings domes must be placed at the sidewalk/track interface, to alert pedestrians with vision impairments of the presence of tracks.



Railroad Crossing

Paths

Unpaved Paths

In general, the standard width of an unpaved path is the same as for sidewalks. An unpaved path should not be constructed in lieu of a sidewalk.

The surface material should be packed hard enough to be usable by wheelchairs, strollers and children on bicycles (the roadway should be designed to accommodate more experienced bicyclists). Recycled pavement grindings provide a suitable material: they are usually inexpensive and easy to grade (this should be done in the summer, when the heat helps pack and bind the grindings).

Paved Paths

See Chapter 7 for standards for shared-use paths.

Transit Stop Connections

Transit depends on walking to function well; most transit users walk to and from transit stops. The sidewalk network supports transit by providing walkways to bring people to and from transit stops, and by providing safe and convenient crossings at transit stops. Since there is an element of risk in crossing busy streets, safety improvements must be made at transit stops.

The safety of pedestrians can also be enhanced using a variety of transit operation improvements, usually implemented by the transit agency, in cooperation with the road authority: consolidate, relocate or eliminate stops. Convenient access by passengers must remain at the forefront of all transit stop planning: simply eliminating stops because they are perceived as unsafe may not serve the needs of transit users. Best is to make access and crossing improvements at existing stops that serve passengers well, or relocating them to a safer and more accessible location within a reasonable walk.



Pedestrian crossing paired with transit stop

Sidewalks

At transit stops, sidewalks or paths should be constructed to the nearest intersection or to the nearest section of existing sidewalk. It might also be necessary to wrap a sidewalk around a corner to join an existing sidewalk on a side street. If a transit route does not have complete sidewalks, it is still important to provide a suitable area for people waiting for a bus.

ADA requires an 8 foot by 5 foot landing pad at bus doors. To avoid the choppy effect this creates at bus stops on curbside sidewalks less than 8 feet wide, it is preferable to construct a continuous 8 foot wide sidewalk the length of the bus stop. The wider sidewalk allows passing pedestrians to get by people waiting for a bus.

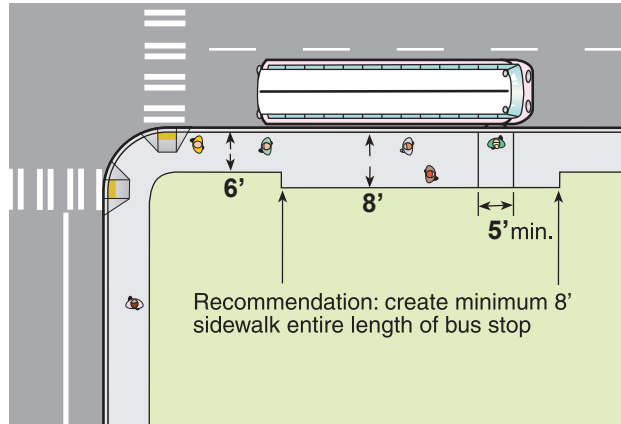

Figure 4-14: Bus stop pad dimensions

At stops in uncurbed areas, the shoulder should be 8 feet wide to provide a landing pad.



Bus stop with shelter in furniture zone

Bus Shelters

A standard-size bus shelter requires a 6 feet x 10 feet pad, with the shelter offset at least 4 feet from the curb for wheelchair clearance. The adjacent sidewalk must still have a 4 feet clear-zone (6 feet preferred) behind or in front of the shelter for sidewalk traffic. Orientation of the shelter should take into account prevailing winter winds. Bike racks should be considered at bus stops in urban fringe areas.

These goals are easier to meet with separated sidewalks, as the shelter and bike racks can be placed in the furniture zone.

Each transit agency may have its own standards for bus shelter pads; walkway construction should be coordinated with local transit agencies to ensure compatibility.



Bus shelter improves transit experience

Bus Pullouts

Where high motor vehicle traffic volumes warrant a bus pullout at an intersection, a far-side location is preferred. The needs of passengers boarding or exiting a bus should not conflict with the needs of pedestrians and bicyclists moving through the area. The curb at the corner should not be recessed, as this creates the illusion of an acceleration lane for right-turning motorists. Placing a curb extension at the corner in line with the rest of the curb helps pedestrian crossing movements, prevents motorists from entering the bus pullout area and reduces conflicts with through bicyclists.

Each pullout should be designed to meet roadway conditions and bus characteristics. The bus pad should be constructed with concrete pavement to avoid heaving, as buses slow to a stop in the pullout.

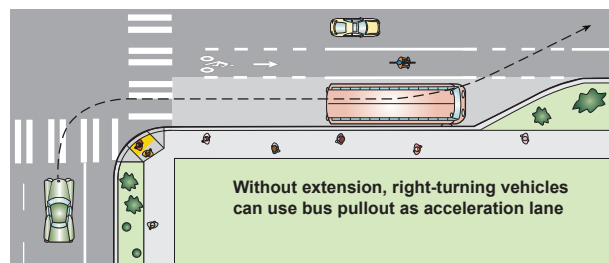

Figure 4-15: Bus pullout at corner adversely impacts traffic

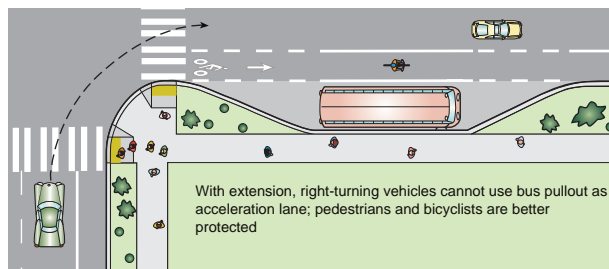

Figure 4-16: Bus pullout with curb extension



Bus pull out

Bus curb extensions

On streets with parking, curb extension bus stops benefit passengers who can board or disembark the bus directly without stepping onto the street. This also makes it easier for passengers with disabilities to board the bus, as it pulls up right next to the curb. The curb extension provides room for a shelter. Curb extensions require a bus to stop in the travel lane; the added delay to motorists is offset by reduced:

1. Dwell time (passengers can board the bus faster); and
2. The bus’s ability to accelerate immediately, without waiting to merge back into traffic.

These two advantages are substantial improvements to transit operations.

A curb extension bus stop may also increase on street parking. The amount of yellow curb required for bus ingress and egress can be greater than the length of a curb extension bus stop.

For a more thorough discussion of designing for transit, please consult the Highway Design Manual.

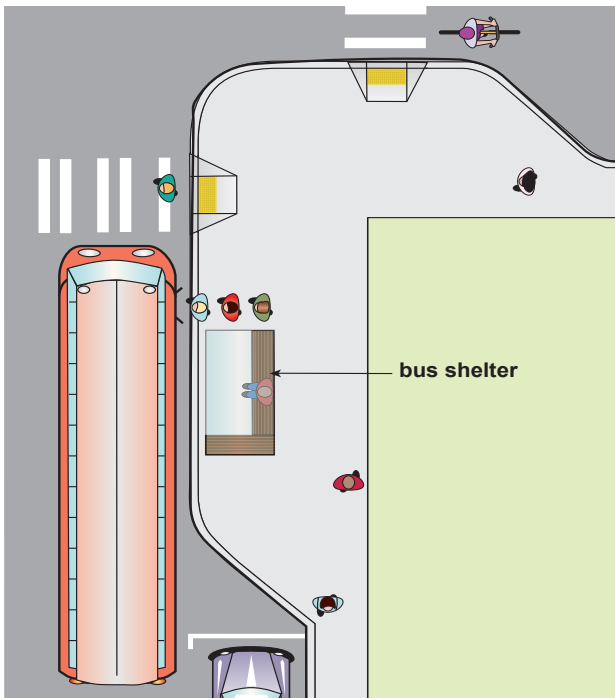

Figure 4-17: Curb extension bus stop



Curb extension bus stop reduces bus dwell time

Transit Stop Crossings

Chapter 5 and 6 discuss street crossings and intersection design; all of the techniques described there can be used to help people cross the street safely and conveniently when accessing or leaving a bus stop. The safety of pedestrians crossing streets to access transit can also be enhanced by using a variety of transit operation improvements. These are usually implemented by the transit agency in cooperation with the road authority, and include consolidating, relocating and eliminating stops.

When a transit stop is located midblock, a single crossing should be provided to serve both directions of bus travel; if a crosswalk is marked, it should be behind the bus stop, so:

- Pedestrians cross behind the bus, where they can see traffic (crossing in front of a bus blocks visibility);
- The bus driver can accelerate as soon as passengers have left the bus; and
- The driver won’t accidentally hit a pedestrian crossing in front of the bus.

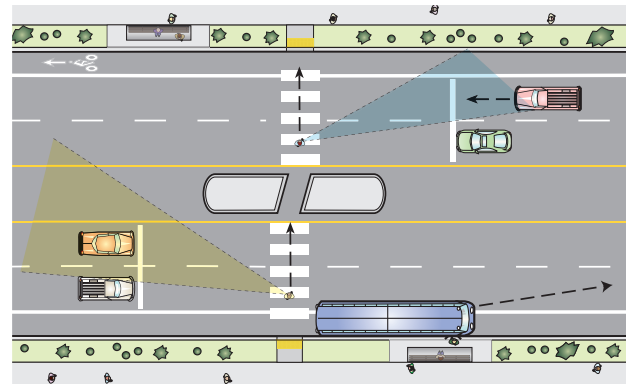

Figure 4-18: One crossing serves bus stop in both directions

For a variety of operational reasons, at intersections, farside stops are usually preferred. One advantage is that pedestrians cross in back of the bus. However, transit operators often must place stops nearside, for reasons such as a concentration of users at a nearside corner, or because the bus route makes

a right turn at that intersection. In all cases the safety and convenience of pedestrians must be a high priority.



Pedestrian crossing to rear of transit stop

Accommodating People with Disabilities

The Americans with Disabilities Act (ADA) requires that transportation facilities accommodate the disabled. For most practical purposes, pedestrians with mobility and vision impairments need greater attention. The essential ADA requirement is to create a pedestrian access route to link community destinations. Within the public right-of-way, sidewalks are considered the pedestrian access route, as well as crosswalks, pedestrian refuge islands, traffic signals and other pedestrian features. Minor improvements can greatly improve accessibility. ODOT sidewalk standards meet or exceed minimum ADA requirements.

Note: at the time of publication, the Access Board has not finalized the Americans with Disabilities Act Accessibility Guidelines for the Public Rights-of-Way (PROWAG). (The ADA Accessibility Guidelines [ADAAG] pertain primarily to buildings and building sites.) FHWA's September 12, 2006 memo addresses compliance with the ADA and states, "Sidewalks and street crossings generally should use the guidelines the Access Board is proposing for public rights-of way" i.e. PROWAG.

PROWAG and ODOT Standard Drawings should be used to construct curb cuts,

driveways, accessible signals and other facilities designed for pedestrians with disabilities.

The US Access Board website has the latest guidelines:

<http://www.access-board.gov/prowac/draft.htm>

The Oregon DOT Bicycle and Pedestrian program website has links to ODOT's standard drawings:

<http://www.oregon.gov/ODOT/HWY/BIKEPED/>

The purpose of this section is to provide general guidance; please refer to the standard drawings for construction details.

It is much easier to meet the ADA requirements with separated sidewalks for several reasons:

- Obstacles such as poles can be placed in the furniture zone;
- Driveway aprons and curb ramps can be placed in the furniture zone, leaving the sidewalk level; and
- Sidewalks, curb cuts and crosswalks line up better at intersections.

These and others are reasons why separated sidewalks should always be the design of choice.

Width

The 6 foot standard sidewalk width exceeds the ADA minimum passage requirements. The ADA required pedestrian access route is minimally 4 feet wide with 7 feet vertical clearance. Pinch points, such as at poles or other obstructions must comply with this requirement. **The ADA minimum clearance width is not an acceptable continuous sidewalk width.**

Grades

Grade standards pertain mostly to separated paths on independent alignments and curb ramps. Where sidewalks are directly adjacent to a roadway, they may follow the grade of the roadway.

ADA requires that the grade of building access ramps and separated pathways not exceed 5%. A maximum grade of 12:1 (8.33%) is acceptable for a rise of no more than 2.5 feet if a 5 foot long level landing is provided after each 2.5 foot rise.

While this may be suitable for short distances, such as a ramp to the entrance of a building, a 12:1 slope followed by a level landing over a long distance creates a choppy effect that is difficult to construct. The overall grade achieved by a configuration of three consecutive rises of 2.5 feet with 5 feet landings in between and at each end is 7.1%. It may be preferable to extend the length of the facility to achieve a constant 5% grade.

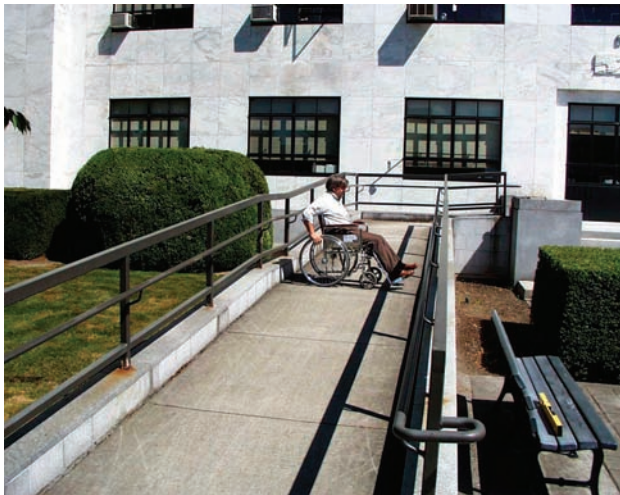

Level landing provides resting area

Continuous sidewalk should also be constructed in accordance with the above guidelines. Where terrain is a challenge, sidewalks adjacent to a roadway may be constructed at the same grade as the roadway, but not steeper. Occasional level rest areas are recommended and care must be taken to address slopes at street crossings.

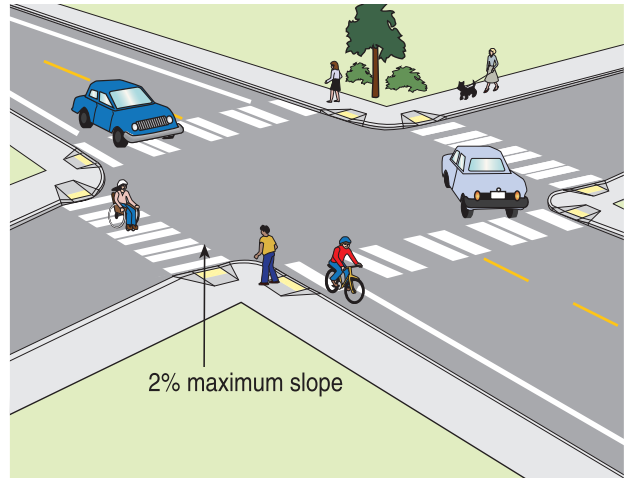

Figure 4-20: Crosswalks maintained at 2% cross slope in steep terrain

Cross-Slope

The maximum allowable cross-slope (needed for drainage) for the pedestrian access route portion of a walkway is 2%. Across driveways, curb ramps and road approaches (in crosswalks, marked or unmarked), a 4 foot minimum wide area must be maintained at 2%.

The most frequent interruptions to the level pedestrian access route are at driveways. To facilitate wheelchair movement at driveways, the following techniques prevent an exaggerated warp and cross-slope:

- A furniture zone allows sidewalks to remain level, with the driveway grade change occurring in the furniture zone.
- Reducing the number of accesses reduces the number grade conflicts.

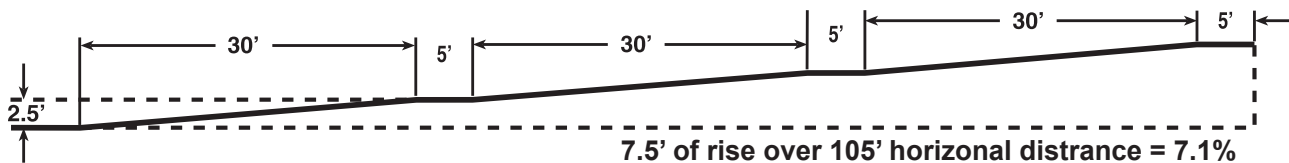

Figure 4-19: Grade guideline for building access ramps and separated pathways



Steep cross slope (4%) is difficult to traverse in a wheelchair

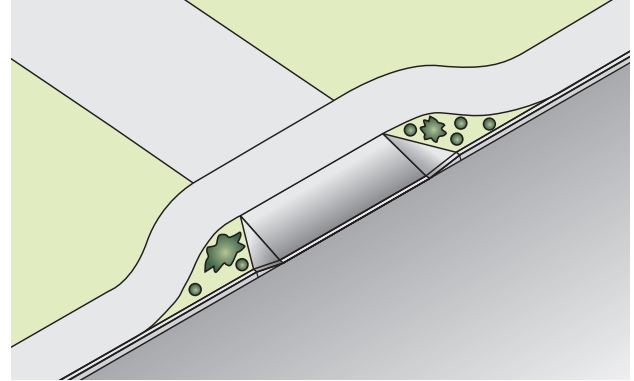

Figure 4-22: Curb tight sidewalk wraps to the back of driveway

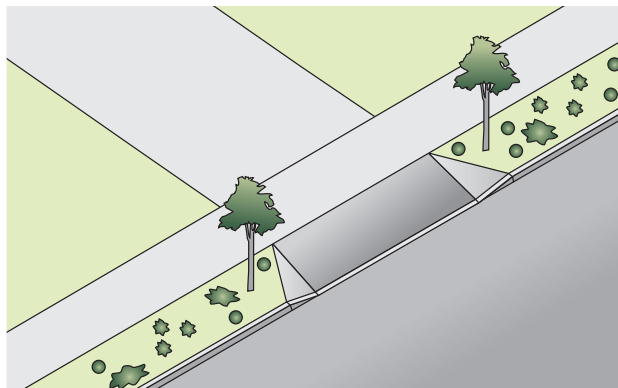

Figure 4-21: Furniture zone maintains sidewalk continuity



Sidewalk is kept level at driveway

When constraints allow for only minimal sidewalks behind the curb, dipping the entire sidewalk at approaches keeps the cross-slope at a constant grade. This requires pedestrians to go up and down at every driveway, in a roller coaster manner and may create drainage problems on and behind the sidewalk.



Separated sidewalk stays level at driveways and is free of obstacles

Where constraints don't allow a furniture zone, wrapping the sidewalk around driveway entrances has a similar effect. Wide sidewalks have enough room to avoid excessively steep driveway slopes; the overall width must be sufficient to avoid an abrupt driveway slope.

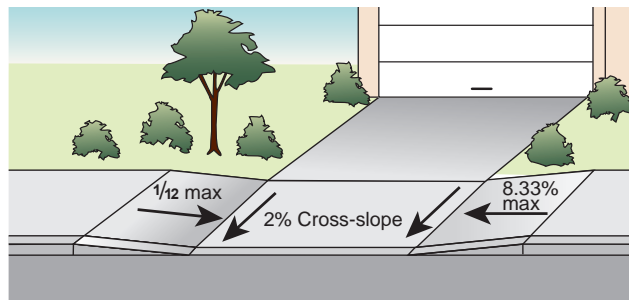

Figure 4-23: Entire sidewalk dips at driveway, but beware the roller coaster effect



Lowering the entire sidewalk should be a last resort

There are a number of variations on the above themes: partially lowering the sidewalk, wrapping the sidewalk around the driveway and partially lowering it, etc. Care should always be taken to keep the sidewalk as level as possible and to reduce out of direction travel.

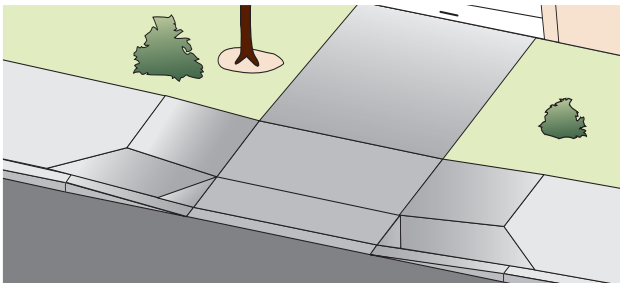

Figure 4-24: Partially lowered sidewalk at driveway

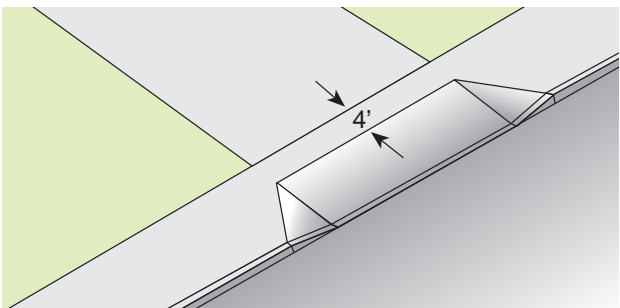

Figure 4-25: Minimum pedestrian access route maintained level at driveway



Wide sidewalk accommodates driveway and keeps pedestrian access route level

The other instance where cross-slope can be a concern is on older sidewalks adjacent to buildings. It's not uncommon for the street, the sidewalks and the buildings to have settled over time, at different rates. The sidewalk cross-slope often greatly exceeds 2% in these circumstances. The mitigation measures need only apply to the pedestrian zone, not the furniture or frontage zones; these two zones can be used to make up for the excessive cross-slope.

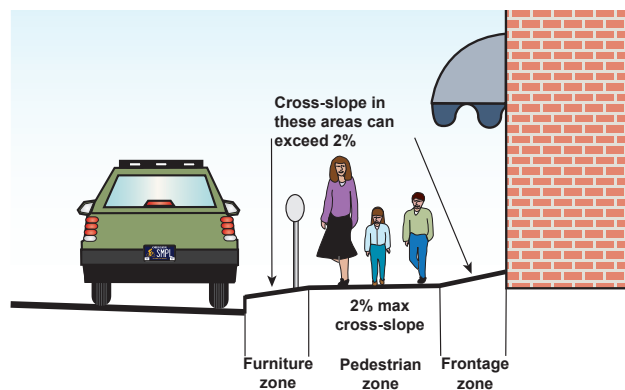

Figure 4-26: Steeper cross slopes in furniture and frontage zones keep pedestrian zone level



Furniture zone accommodates needed grade changes, keeping pedestrian zone level

Ramps

ADA recommends two ramps per corner at intersections for new construction, as a single diagonal ramp may direct users into the travel way. A single ramp is allowable on retrofit projects where circumstances prohibit the installation of two ramps; however, in most cases two ramps can and should be accommodated even on retrofit projects. A 4 foot wide passage with a maximum cross slope of 2% must be maintained behind ramps.

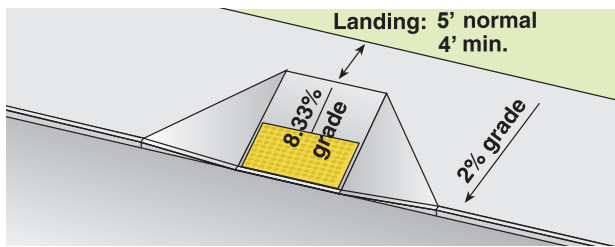

Figure 4-27: "Standard" ramp



"Standard" curb ramp

Ramp Types

The ramp shown in Figure 4-27 works when there is a furniture zone, curb extension, or wide sidewalk; there are many situations in which this design will not work, particularly for narrow curbside sidewalks. The following ramp styles also meet ADA curb ramp requirements.

Parallel ramp

To be used on narrow curbside sidewalks.

Advantages:

- Easy to construct; and
- Ramp is full width of sidewalk.

Disadvantages:

- All pedestrians must go down and up ramp; and
- May cause drainage problems.

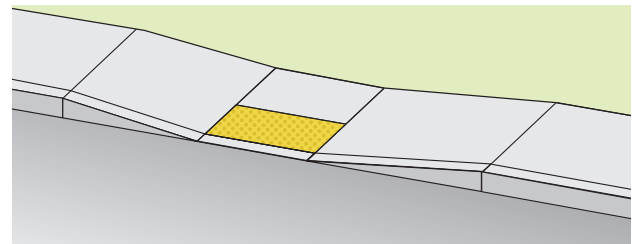

Figure 4-28: Parallel curb ramp



Parallel curb ramp

Perpendicular ramp

To be used on separated sidewalks (with furniture zone/landscaped buffer).

Advantages:

- Easy to construct;
- Ramp may be full width of sidewalk or crosswalk;

- Pedestrians not using ramp may bypass it; and
- Minimizes impact on landscape area.

Disadvantage:

- Cannot be used in narrow rights-of-way.

Note: Wings are required only when furniture zone is traversable, (i.e. when it is paved).

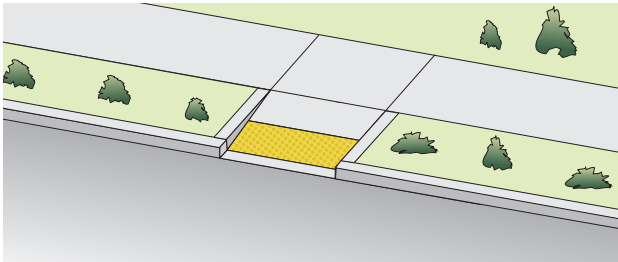

Figure 4-29: Perpendicular ramp



Perpendicular Curb Ramp

Perpendicular ramp with one flare

To be used on wide curbside sidewalks where an obstacle prevents construction of a flare.

Advantage:

- Avoids having to construct flare.

Disadvantage:

- Requires special forming.

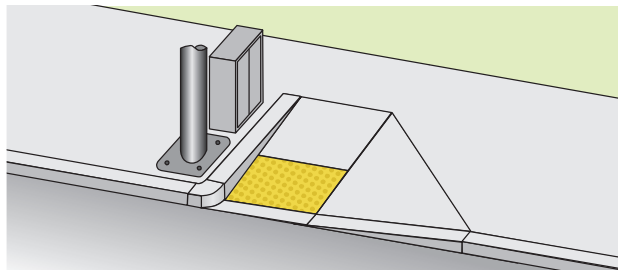

Figure 4-30: Perpendicular ramp with one flare



Curb ramp with one flare

Combination ramp

To be used on sidewalks where circumstances prevent construction of standard or parallel ramps.

Advantage:

- Can be used in constrained areas with difficult grades.

Disadvantage:

- Requires special forming.

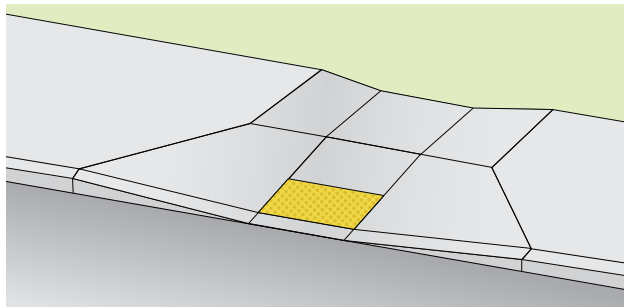

Figure 4-31: Combination curb ramp



Combination curb ramp

Ramp Placement

Placement of the ramp within the intersection is crucial for safety and accessibility. Chapter 6, Intersection Design, covers ramp and crosswalk placement in greater detail; this section discusses the main issues that pertain to accessibility. These rules should be followed:

- Ramps must be wholly contained within the crosswalk lines (flares may fall outside the crosswalk);
- Two ramps per corner should be provided, where feasible;
- Ramps should be placed as close to the intersection as possible; this is made easier by keeping the curb radius tight, and the curb height between two adjacent ramps to no more than 3 inches; and
- Drainage grates should be provided upstream of ramps to prevent water ponding.

The following figures illustrate possible ramp placement scenarios:

Separated sidewalks

Sidewalks with furniture zones make ramp placement very simple. Two perpendicular style ramps prolong the sidewalk down to the crosswalk; flares are not needed where the furniture zone is landscaped.



Figure 4-32: Ramp placement, sidewalk with furniture zone



Ramp placement on separated sidewalk, NOTE: outside flares are not required.

Curb tight sidewalks

By their very nature curb tight sidewalks make placing two ramps difficult. On wide sidewalks with small corner radius (under 25 feet), two ramps can be placed close together.

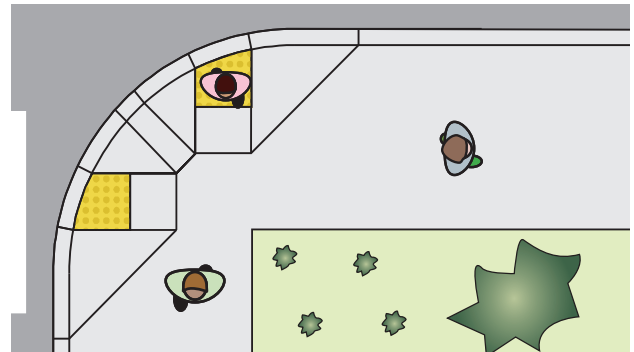

Figure 4-33: Ramp placement on wide curbside sidewalk

On larger radius curves, the ramps (and crosswalks) will be placed further apart. In this case, two parallel ramps work well on curbside sidewalks.

In both cases, limiting the curb height (3 inches min curb exposures) between the two ramps brings them closer together.

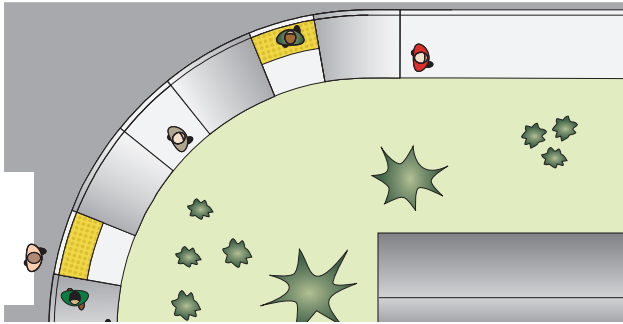

Figure 4-34: Ramp placement on narrow curb tight sidewalk

In constrained circumstances, such as against existing buildings, one ramp may be the only option. A 4 foot setback must be provided where the crosswalks meet, so a person using the ramps in a wheelchair can reorient himself in the crosswalk, not the travel lanes. This design is the least desirable, as people in wheelchairs must take a circuitous route to cross the street in either direction.

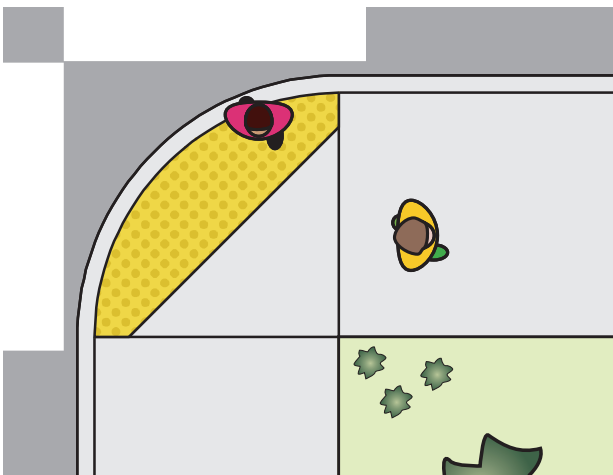

Figure 4-35: Single ramp placement on constrained sidewalk

In all cases, reducing the curb radius makes it easier to place ramps so they line up with the sidewalks and crosswalks.

Ramp Elements

APWA/ODOT standard drawings and PROWAG, among other resources, provide detailed information on required ramp elements.

Pedestrians with Visual Impairments

Sidewalks should be designed so people with vision impairments can find their way via a clear delineated edge, without hitting obstructions. Separated sidewalks satisfy this basic requirement. Sidewalks must be built with no protruding objects within the paved area; the specific requirements are:

- 80 inches minimum vertical clearance;
- No objects protruding from wall more than 4 inches at a height greater than 27 inches; and
- Any object protruding more than 4 inches at a height greater than 27 inches must be detectable with a curb or other detectable feature on the ground.

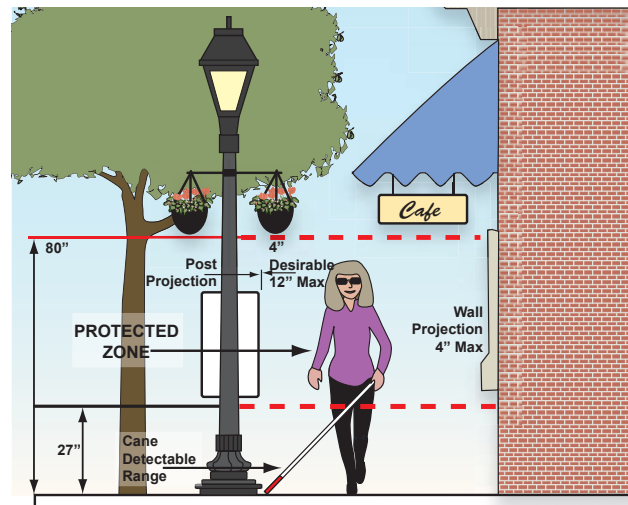

Figure 4-36: Blind pedestrian with clearances

Pedestrians with visual impairments must also be able to locate crosswalks and travel across streets at intersections. The visually impaired may have difficulty locating the crosswalks where the crossing points are not readily apparent, for example at a corner with a large radius or diagonal ramp. There are several techniques that enhance the environment for the vision-impaired:

- Keeping intersections tight and square to limit long and skewed crosswalks;

- Placing crosswalks in areas where they are expected (in line with ramps and sidewalks);
- Keeping crosswalks straight across the street;
- Providing accessible pedestrian signals; and
- Using detectable warnings at ramps to identify the transition from the sidewalk to the street.

These features are discussed in greater detail in Chapter 6, Intersections.

Other Pedestrian Facilities

Pedestrians are exposed to the weather and use their own energy to move, and several low-cost improvements can be made to provide a better environment. In all cases these features must be located outside of the pedestrian zone, in either the furniture or the frontage zones.

Benches

People walking want to sit down and rest occasionally. In an urban setting, wide sidewalks, furniture zones and curb extensions provide opportunities for placing benches out of the walking zone.



Bus shelter in furniture zone

Awnings

Where buildings are close to the sidewalk, awnings protect pedestrians from the weather and can be a visual enhancement to a shopping district.



Bench in furniture zone

Shelters

At bus stops, transfer stations and other locations where pedestrians must wait, a shelter makes the wait more comfortable. People are more likely to ride a bus if they don't have to wait in the rain.



Awning shades sidewalk cafe

Landscaping

Landscaping can greatly enhance the aesthetic experience for pedestrians, making the walk less stressful or tiring. Landscaping can increase

the effectiveness of a planting strip as a buffer between travel lanes and sidewalks, as well as mask features such as sound walls. Choosing appropriate plants and ground preparation are important. The following guidelines should be considered:

- Plants should be adapted to the local climate and fit the context; they should survive without protection or intensive irrigation, and should require minimal maintenance, to reduce long-term costs.
- Plants must have growth patterns that do not obscure pedestrians from motor vehicles, especially at crossing locations, nor must they obscure signs.
- Plants should not have roots that could buckle and break sidewalks (root barriers can prevent buckling); the soil should be loosened and treated with mulch deep enough so plants can spread their roots downward, rather than sideways into the walk area.
- Planting strips should be wide enough to accommodate plants grown to mature size.



Landscaping provides storm water treatment

Drinking Water Fountains & Public Restrooms

Drinking water fountains and public restrooms make it easier for pedestrians to be outdoors for a long time and to walk long distances without

worrying about where to find a business that will accommodate their needs.

Other Considerations

Driveways

Accesses to private property can be built as conventional driveways, or with designs that resemble street intersections. For pedestrian safety and comfort, the conventional driveway type is preferred, as motorists must slow down when crossing the driveway, and the right of way is clearly established, as motorists cross a sidewalk.

Intersection-type driveways can disadvantage pedestrians as motorists can negotiate the turn at faster speeds, and the right of way is not as clearly established, the driveway and roadway appear continuous.

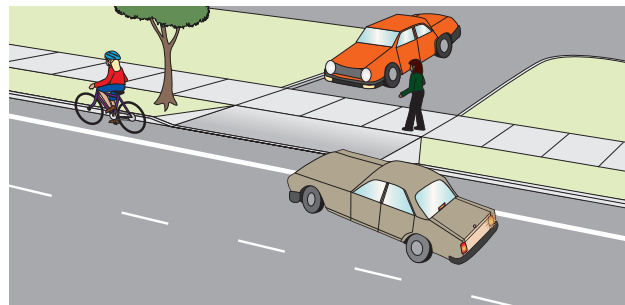

Figure 4-37: Conventional driveway design



Dustpan style driveway approach improves pedestrian safety

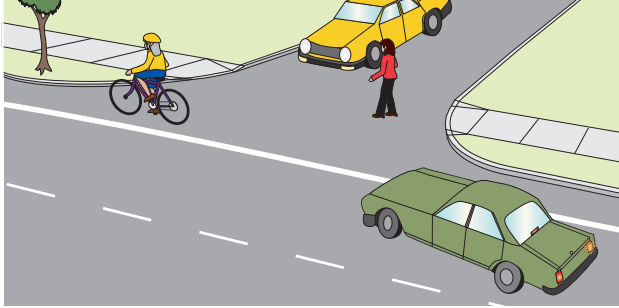

Figure 4-38: Intersection style driveway

Where an intersection-style driveway is used (such as to implement a “right-in, right-out” policy), the following techniques can be used to alleviate the above concerns:

- The street surface material should not carry across the driveway - rather, the sidewalk should carry across the driveway at sidewalk height, so motorists know they are entering a pedestrian area;
- The curb radius should be kept as tight as possible;
- Driveway widths should be the minimum needed to accommodate entering and exiting vehicles; and
- Where the volume of turning vehicles is high, right-turn channelization should be considered, to remove slower turning vehicles from the traffic flow, allowing them to stop for pedestrians. A traffic signal should be considered where the turning movements are very high.

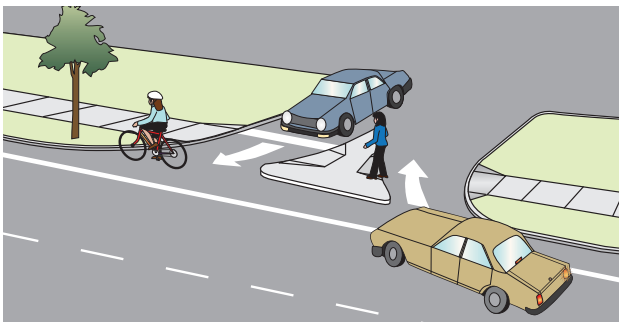

Figure 4-39: Right-in, right out driveway



Commercial right-in, right-out driveway. NOTE: truncated domes are used ONLY at commercial style driveways.



Commercial driveway with wrapped, level sidewalk and pork chop island

Alleys

Alleys are often surfaced with the same paving material as the roadway, so drivers may not realize they are crossing a sidewalk when they exit an alley. Alleys present problems for pedestrians if they are not noticed by exiting drivers. Several measures can improve pedestrian visibility:

- Designing alleys like driveways, by continuing the sidewalk grade and surface design (texture and color) across the alley, so motorists know they are entering a pedestrian zone; and

- Placing stop signs or a speed hump before the front of a vehicle protrudes onto the sidewalk.

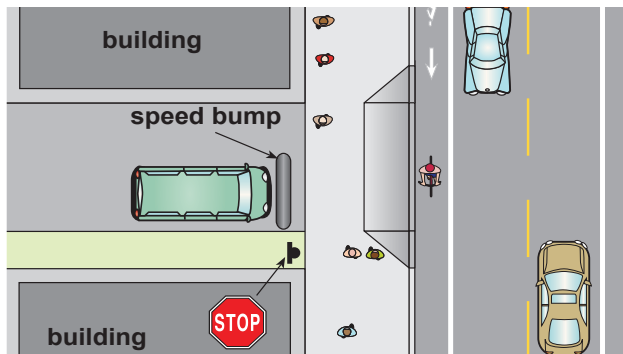

Figure 4-40: Alley clearly crosses a sidewalk



Sidewalk thru alley entrance is kept level

Signs

Walkways generally require little signing. Most regulatory and warning signs are directed at motor vehicle traffic. See chapters on street crossings and intersections for signs required in those situations.

Directional/Way finding Signs

Signs intended primarily for motorists often do not serve pedestrians well. For example directional signs are typically large, mounted fairly high, and indicate destinations relatively far away; on one-way streets, street name signs are often mounted only in the direction facing motor vehicle traffic, yet pedestrians approach from all directions.

Most walking trips are short, and the pedestrian's line of sight is lower, so developing pedestrian-scale wayfinding signs that lead to destinations within walking distance can improve the walkability of an area. Signs can assist pedestrians new to the area, or residents who may not realize that the best route on foot is shorter or different than what they are used to driving. Examples of key destinations to include are libraries, schools, museums, recreation centers, shopping districts, city services, etc.

No standards have been developed yet for pedestrian directional signs. Signs should be unobtrusive, easy to read and aesthetic. This example gives distances in blocks; other measures could be average walking time. Distances in miles are not very meaningful to pedestrians.



Figure 4-41:D1-3b

Street Signs

Most street signs adequately serve pedestrians. But street signs on one-way streets often face only motor vehicle traffic. Adding lower level streets signs facing both ways helps pedestrians walking against the direction of traffic, so they can see the names of cross-streets. On two-way streets, signs mounted

high on mast arms over the roadway should also be supplemented with conventional, smaller signs on the street corners.

Practices to be Avoided

Meandering Sidewalks

Meandering sidewalks are used in several scenarios:

1. Sidewalks can meander to wrap around large obstacles, such as a mature tree or power pole.
2. Sidewalks can meander in topographically constrained areas, and follow the natural contours of the land.

Both these approaches are acceptable, even desirable. But sidewalks often meander with the intention of softening the look of a curbed urban

street in a semi-rural or suburban environment. Though it adds some aesthetic value, and offers possibilities to add creative landscaping touches, the results are often quite different:

- Most pedestrians prefer to walk directly, in a straight line;
- Construction costs are higher, due to the need for special forms;
- Long-term maintenance costs are higher, as it's more difficult to maintain a curved edge than a straight edge; and
- Once the novelty has worn off, meandering sidewalks are often the object of ridicule and even resentment when the public realizes funds were spent on a sidewalk that doesn't serve users well.



Meandering a sidewalk for no purpose should be avoided.

CHAPTER 5: STREET CROSSINGS



A successful pedestrian network requires safe and convenient crossing opportunities

Introduction

Walkways along a road provide mobility, but a successful pedestrian network also requires safe and convenient street crossing opportunities. Wide roads carrying large traffic volumes can be obstacles to pedestrians who need access to destinations on the other side of the street. Pedestrians are less visible and less protected than motorists; well-designed roads take this into account.



Many crossings occur midblock out of convenience

Most pedestrian crashes occur when a pedestrian crosses a road, at intersections and other locations. Midblock crossings are a fact that planners and designers need to consider: people will take the shortest route to their destination. Prohibiting such movements is counter-productive if pedestrians continue to cross the road with no protection. It is better to design roadways that enable pedestrians to cross safely.

Safe street crossings also benefit transit users; in most cases access to or from a bus stop requires crossing a street. Many pedestrian crashes are associated with bus stops. See Chapter 4 “Transit Stop Crossings” for a discussion on transit planning and bus stop locations.

Safe street crossings also benefit motorists who park on one side of a street to access destinations across the street. Sidewalks and crossing opportunities allow drivers to park once and walk to several destinations.



Pedestrian crossings help shoppers access both sides of the street.

Crosswalks Defined

Oregon law defines a crosswalk as the prolongation of a curb, sidewalk or shoulder across an intersection, whether it is marked or not. Outside an intersection, a crosswalk is created with markings on the road. See ORS 801.220 for the complete legal definition of a crosswalk.

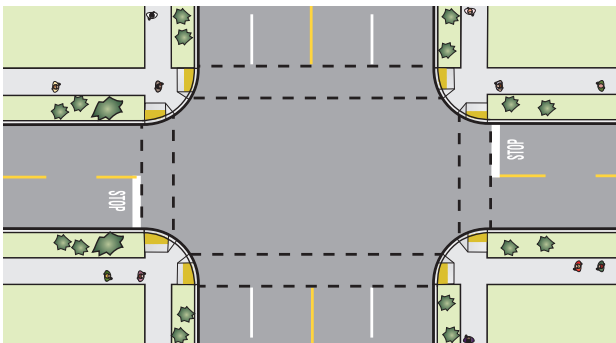

Figure 5-1: All legs of all street intersections are crosswalks, regardless of the presence of sidewalks, shoulder or other "pedestrian" facility

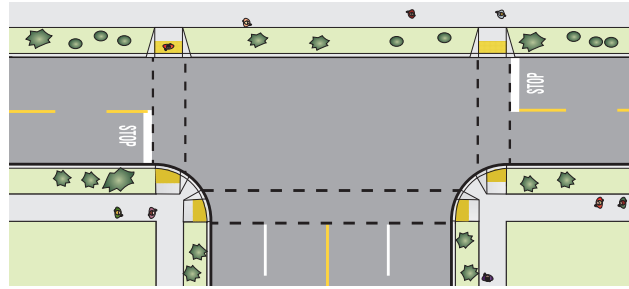

Figure 5-2: Crosswalks defined for T-Intersection

Legal Crossings

“Jaywalking” is not a legally defined term in Oregon law. It does not mean crossing a street midblock. The Oregon Vehicle Code states that it is illegal for pedestrians to:

- Cross a street against a traffic signal;
- Cross the street outside of a crosswalk without yielding to vehicular traffic;
- Cross the street outside of a crosswalk at an intersection; and
- Proceed in a crosswalk in a manner that causes an immediate hazard to an approaching motor vehicle.

The right of way laws are:

- At non-signalized crosswalks, marked or unmarked, drivers stop and remain stopped for pedestrians (ORS 811.015, 017 and 028).
- At signalized crosswalks, when the pedestrians are proceeding in accordance with the traffic signal, drivers stop and remain stopped for pedestrians (ORS 811.028). Pedestrians are required to obey traffic signal indications (ORS 814.010).
- At other locations, crossing is allowed, but pedestrians yield to vehicles (ORS 814.040). Some local jurisdictions have passed ordinances prohibiting crossings outside of



crosswalks between signalized intersections.

Crossing the street is not a crime

In many instances, a midblock crossing has fewer conflicts than a crossing at an intersection, as gaps in traffic are easier to judge; at intersections, there are additional conflicts with vehicles turning left and right into the pedestrian's path. On one-way streets the upstream side of the intersection has fewer conflicts; there is no turning traffic and the pedestrian need only find a gap in one direction of traffic.

Oregon's crosswalk laws provide a buffer of safety for pedestrians on the roadway. When turning at a traffic signal, drivers must stop and remain stopped for pedestrians until they have cleared the lane into which their vehicle is turning and at least 6 feet of the next lane. At any other crosswalk drivers must stop and remain stopped for pedestrians until they have cleared the lane in which they are traveling or turning and the next lane.

Planning and Design Issues that Affect Crossings

Safe and convenient pedestrian crossings must be considered when planning and designing urban and suburban roadways. The following issues should be addressed when seeking solutions to specific problems:

Level of Service (LOS), Speed & Appropriate Design Standards

Appropriate design standards take into account the needs of all users. Pedestrian access and mobility should be considered when determining the desirable LOS and speed for a roadway. In some areas, pedestrian needs should be elevated above the needs of motorized traffic (e.g. downtown or near schools).

There is often an inverse relationship between traffic volumes and/or speeds and the ease of pedestrian crossing, which can lead to conflicting goals when determining priorities for a roadway:

- Some design features, such as raised medians, benefit all users;
- Some designs intended to increase motor vehicle traffic flow may reduce pedestrian crossing safety and opportunities (e.g. it is difficult for pedestrians to cross a large number of travel lanes); and
- Some designs that facilitate pedestrian crossings may reduce motor vehicle capacity (e.g. pedestrian signals).

In many cases actual travel speeds are higher than is appropriate for the adjacent land use, and improvements to facilitate pedestrian crossings may help reduce traffic speeds to desirable and legal limits. These include refuge islands and curb extensions. Many residential streets carry faster-moving traffic than the street is designed to carry. The design of a road should not encourage excessive speeds; even a major street can be treated for pedestrian safety without degrading capacity.



A wide, multi-lane street built for motor vehicle capacity is difficult to cross

Land Use

As the number and density of pedestrian-accessible origin and destination points along a road increases, so does the demand for pedestrian crossings. On corridors with concentrated nodes of activity, special crossing treatments are easier to justify at locations where crossings will likely occur. Examples include apartment complexes, senior citizen centers, schools, parks, shopping areas, libraries, hospitals and other public or institutional uses. On corridors with scattered development and residences, it is difficult to predict where crossings may occur.

Planners and transportation officials must work together to ensure that land use is compatible with the roadway design, and vice versa.



It is difficult to determine where pedestrians will cross on auto oriented streets with diffuse destinations

Transit Stops

Most transit users will have to cross the road to access a transit stop on one leg of their trip. Coordination between public transit agencies and transportation designers is essential to ensure safe pedestrian crossings. By coordinating land use, roadway design and transit stops, passengers will be more secure when boarding or leaving a bus, and walking to or from their destination at either end of the transit trip. See Chapter 4 “Transit Stop Crossings” for a discussion on transit planning and bus stop locations.

Signal Spacing

Signalized intersections may be the preferred pedestrian crossing points at peak traffic hours; other crossing opportunities close to signalized intersections benefit from a “platooning” effect, as traffic signals create gaps in traffic. The effect decreases:

- As the distance from the signalized intersections increases;
- As traffic volumes increase; or
- If poor access management allows vehicles to continually enter the roadway between signals.

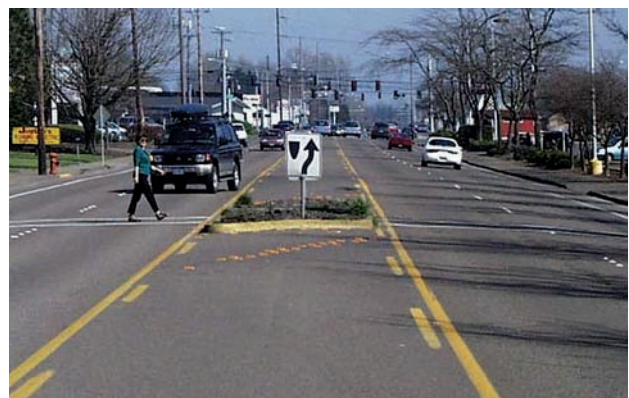

Traffic signal in distance creates adequate gaps for pedestrians to cross street

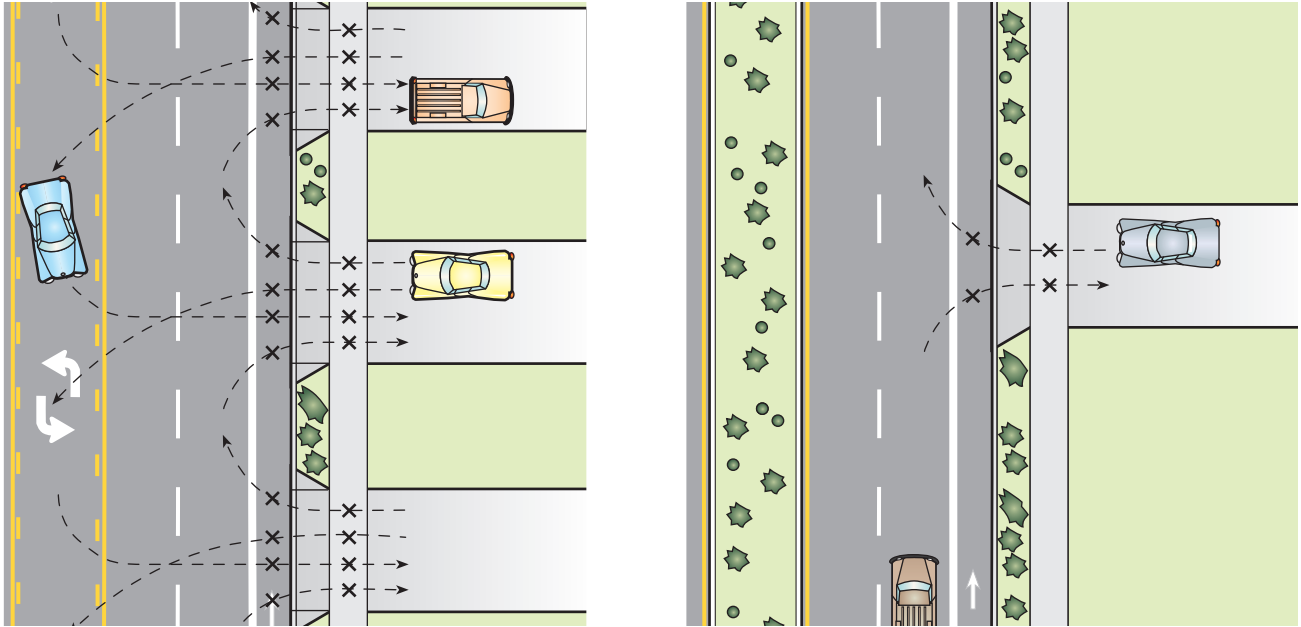

Figure 5-3: Access management techniques such as raised medians and consolidated driveways reduce conflict points

Access Management

Many uncontrolled accesses to a busy road decrease pedestrian crossing opportunities and increase risk: when a gap is created in the traffic stream, motorists entering the road from driveways fill the gap, making it hard for the pedestrian to cross.

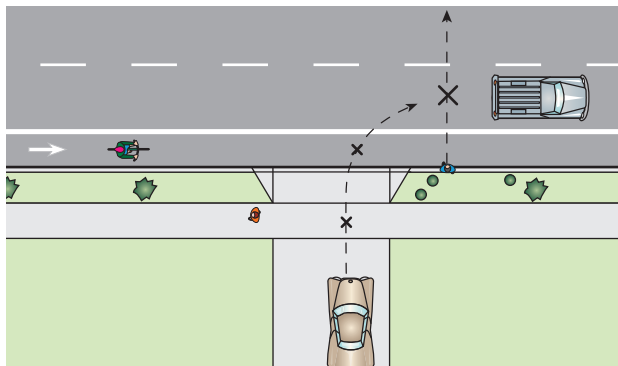

Figure 5-4: Driver and pedestrian waiting for same gap are in conflict when the gap opens up

A well designed raised median or island benefits pedestrians: it provides a refuge, and allows them to cross one direction of traffic at a time (pedestrians seeking refuge in a center turn lane are unprotected). However, arbitrarily

eliminating road connections and signals also eliminates potential pedestrian crossing opportunities and increases risk.

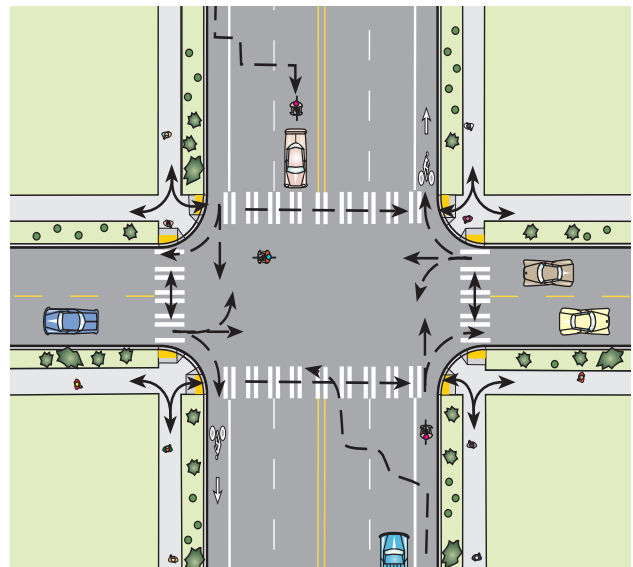

Figure 5-5: Intersection with all turn and crossing movements

Creating an urban expressway can increase traffic speeds and volumes. Concrete barriers placed down the middle of the road (rather than a raised median) effectively prohibit pedestrian crossings.

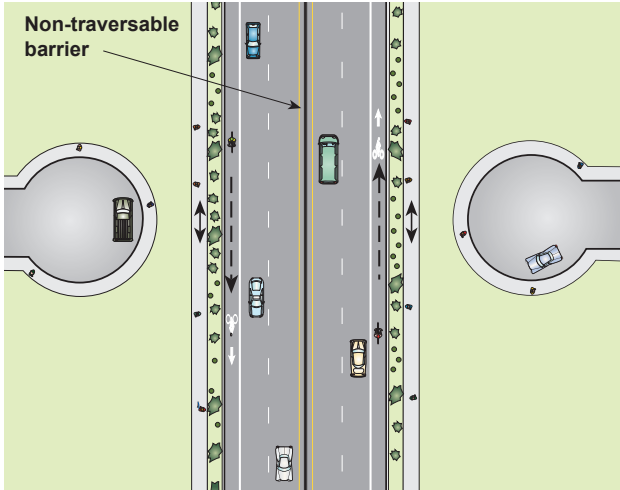

Figure 5-6: Severed streets and non-traversable barrier reduce pedestrian travel options

Out-of-Distance Travel

Though some crossing solutions appear to offer greater safety, such as traffic signals or overcrossings and undercrossings, excessive added travel distance will discourage pedestrians who want to take a more direct route; they may end up making unsafe crossings. A crossing such as a traffic signal or grade-separated structure must offer obvious advantages.

Midblock vs. Intersection Crossings

The Oregon Vehicle Code allows pedestrians to cross midblock outside of a crosswalk, but they must yield to motor vehicles (ORS 814.040).

Intersections are recognized by road users as areas where conflicts may occur, and prudent drivers proceed cautiously through intersections, expecting the unexpected. This is cited as a reason to encourage pedestrians to cross at intersections rather than midblock.

But the increased number of conflicts at intersections can also make pedestrians more vulnerable, as both pedestrians and drivers have to be on the lookout for conflicts coming from several directions at once: pedestrians have to watch for drivers making turns and right turning vehicles approach the pedestrian from behind, and drivers are also looking for multiple motor vehicle conflicts. This can cause a situation where both pedestrians and drivers are not aware of each other's intentions. Pedestrians are particularly vulnerable at signalized intersections where left and right turns are concurrent with the pedestrian walk phase.

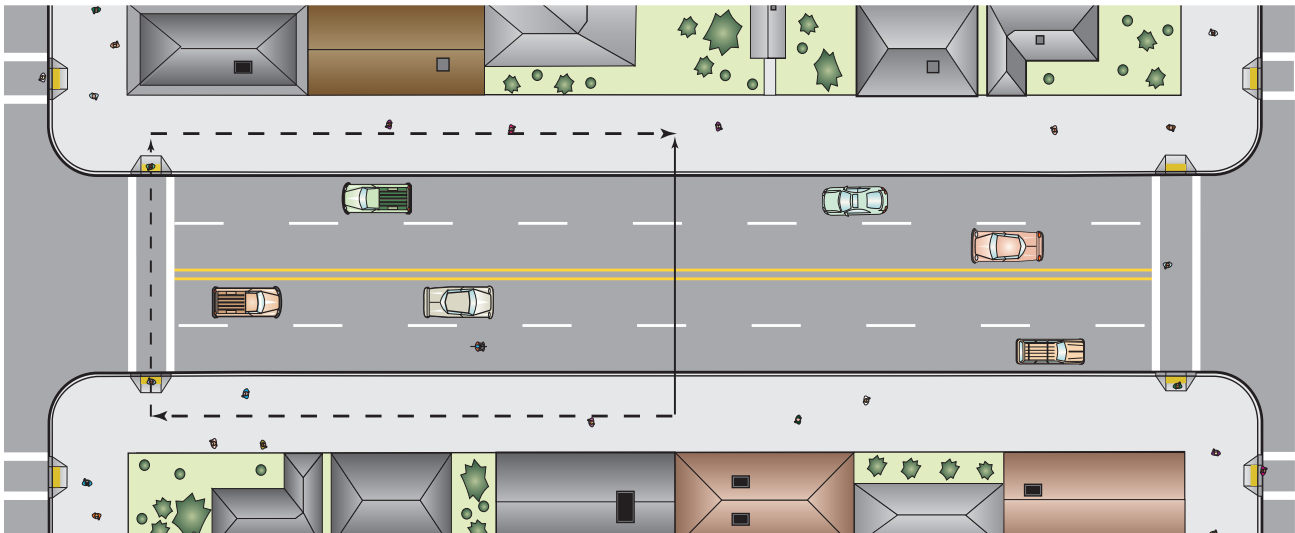

Figure 5-7: Most pedestrians will cross midblock rather than walk to a signalized intersection

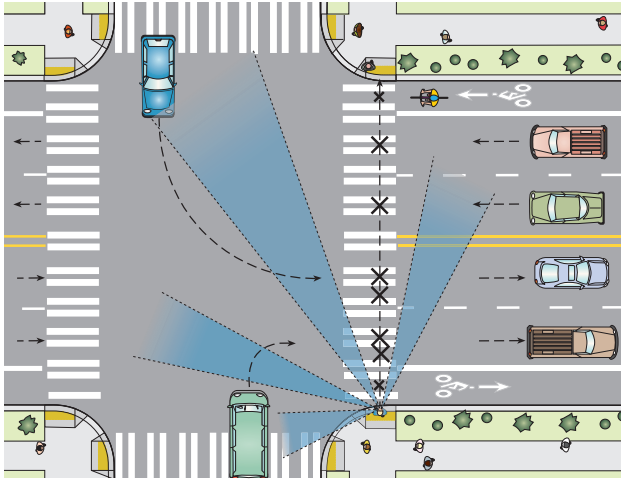

Figure 5-8: Conflicts at intersections are many

At midblock locations, the pedestrian has to look only for traffic on the roadway, and the driver is generally looking straight ahead, at the potential crossing point.

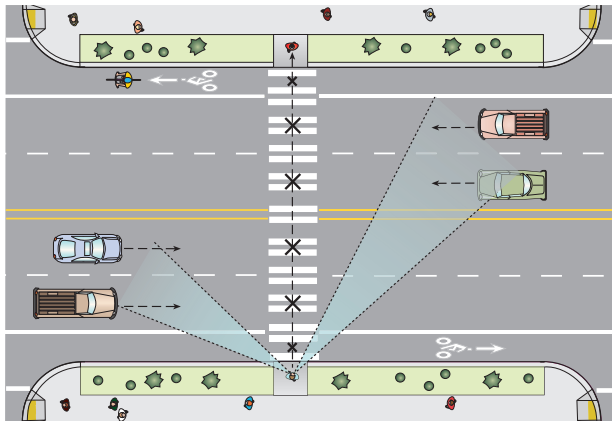

Figure 5-9: Conflicts at midblock crossings may be fewer

A raised median allows pedestrians to cross midblock more easily; they still must yield to motor vehicles. Marking a crosswalk at a midblock location reverses the right of way, as drivers must yield to pedestrians. Midblock crosswalks are established by the appropriate road authority, and must be approved by the State Traffic Engineer on State Highways.

Maintenance

The effectiveness of a design will be lost if maintenance is excessively difficult or expensive. Forethought must be given to the practicality of future maintenance. Facilities will be effective over time only if they are in good repair. Examples of design features to avoid include:

- Vegetation that can obscure pedestrians;
- Restricted areas that cannot accommodate sweepers or other power equipment; and
- Remote areas requiring hand sweeping.

Crossing Solutions

To increase pedestrian crossing opportunities and safety, two approaches can be considered:

1. Designing roads that are inherently easier and safer to cross by incorporating design features such as raised medians, or cross-section elements that slow traffic down or reduce the total roadway width; or
2. Constructing actual pedestrian crossings with features such as refuge islands, pedestrian-activated signals, curb extensions, marked crosswalks, etc.

These solutions are listed in order of complexity and cost; there is no implied preference. No one solution is applicable in all situations, as the issues will usually overlap on any given section of road. In most cases, a combination of measures will be needed to improve pedestrian crossing opportunities and safety. Guidance on crossing treatments on state highways can be found in the ODOT Traffic Manual. The Federal Highway Administration (FHWA) and the National Cooperative Highway Research Program (NCHRP) publish research on pedestrian traffic and are good resources for the latest information on pedestrian crossing treatments.

Crosswalks

The two primary purposes of crosswalks are to indicate to pedestrians a desirable place to cross, and to indicate to drivers where to expect pedestrians to cross. Any marked crosswalk must fulfill these two goals before discussing the relative safety of marked crosswalks.

There is considerable debate concerning the utility and safety of crosswalks. Recent studies have indicated that a marked crosswalk alone is not enough to improve safety of pedestrians crossing busy, multi-lane roads. The latest research on this subject is available in the report “Safety Effects of Marked vs. Unmarked Crosswalks at Uncontrolled Locations: Executive Summary and Recommended Guidelines FHWA-RD-01-075”: <http://www.tfhrc.gov/safety/pubs/04100/04100.pdf>

The basic conclusions are:

- On lower volume/lower speed roads (under 12,000 ADT/ 35 MPH), marking a crosswalk is not associated with increased risk to pedestrians. On multi-lane roads with ADT over 12,000 or speeds over 35 MPH, marking a crosswalk is not sufficient; additional measures such as median islands, curb extensions, illumination and advance stop bars are recommended. At very high traffic volumes and speeds, a signal or grade-separation should be considered.
- A traffic study will determine if a marked crosswalk is appropriate. This is usually in locations that are likely to receive high use, based on adjacent land use.



Painted crosswalk on two lane roadway is appropriate



Good pedestrian crossings on multilane roadways require more than just paint

Crosswalks should be marked at all legs of signalized intersections. The decision to close a crossing must take into consideration the safety and convenience of pedestrians. Closing crosswalks usually forces pedestrians to cross three legs of an intersection to reach the opposite corner, which is inconvenient and exposes them to more traffic conflicts (see Chapter 6 Intersections for more detail).

If motor vehicle stopping compliance at a crosswalk is low, some possible problems include:

- Enforcement: more rigorous enforcement of traffic laws is needed for motorists to understand that it is their duty to yield to pedestrians in a crosswalk, marked or unmarked;
- Location: marked crosswalks must be placed in locations where they are visible (avoid the crest of a vertical curve, for example) and where obstructions such as poles do not affect sight lines;
- Traffic movement: turning vehicles at a nearby intersection or driveway can compromise the crosswalk; and
- Users: some people need extra help crossing a street and crosswalks alone may not be sufficient; for example, young children and elderly pedestrians may need the positive control provided by signals or adult crossing guards.

Crosswalk Striping

Crosswalks should be 10 feet wide, or the width of the approaching sidewalk if it is greater.

The standard in many jurisdictions has been two parallel white lines. The staggered continental crosswalk is more effective because it is more visible to drivers and helps pedestrians with vision impairments locate the crosswalk. And since stripes are placed outside of the wheel tracks, it also reduces long-term maintenance costs due to less wear and tear – they don't need to be repainted as often. Staggered continental crosswalks are recommended at midblock crossings and at intersections not controlled by a stop sign or traffic signal. Signalized intersections may be marked with two parallel lines.

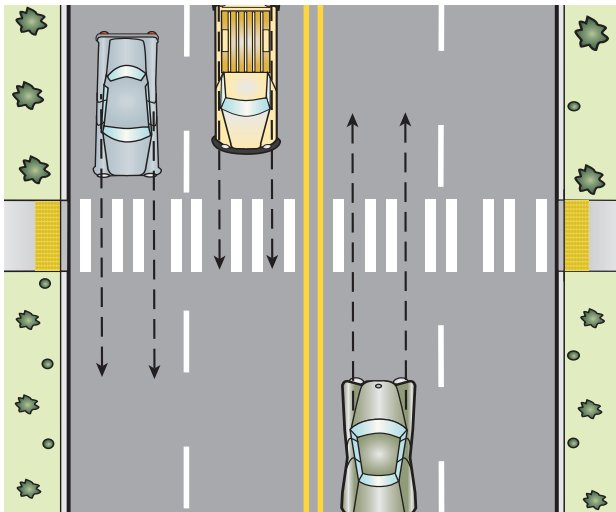

Figure 5-10: Staggered continental crosswalk markings



Staggering markings place stripes out of wheel paths

Advance Stop Lines

One of the main crash types at marked crosswalks on multi-lane roads is the multiple threat crash. This occurs when a driver in the curb lane stops to let a pedestrian cross, but too close to the crosswalk, masking visibility of the pedestrian and the adjacent travel lane. A motorist proceeding in the adjacent lane doesn't notice the first car has stopped to let a pedestrian cross. The pedestrian doesn't see the other car coming and continues to cross, which can result in a high-speed, fatal or severe injury crash.

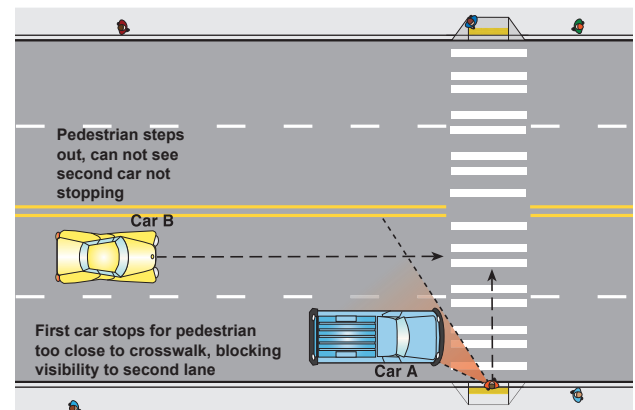

Figure 5-11: Multiple threat crash occurs when Car B does not yield to pedestrian

The likelihood of a multiple-threat crash is greatly reduced with an advance stop line placed 20 feet–50 feet ahead of the crosswalk. This encourages drivers to stop back far enough so a pedestrian can see if a second motor vehicle is not stopping, and take evasive action. Advance stop bars are recommended at midblock crosswalks and at uncontrolled intersections on multi-lane roads.

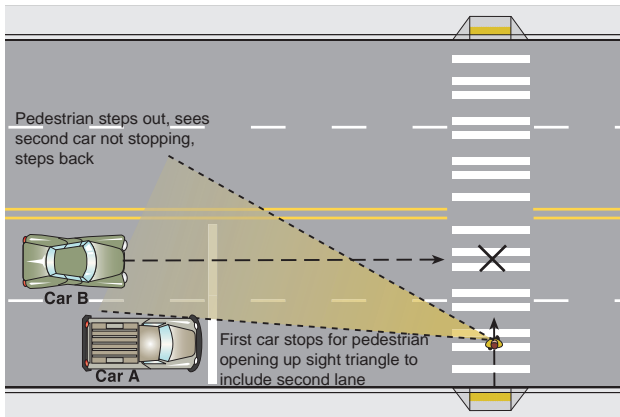

Figure 5-12: An advance stop bar allows a pedestrian to see that Car B has not stopped

The advance stop line should be supplemented with signs to alert drivers where to stop for pedestrians. At least one sign should be placed on the right; a second sign may be placed on a median island.



Figure 5-13: Sign R1-5c are placed adjacent to the stop bar

Signs

Pedestrian Crossing signs should be used at locations where a crossing is not normally encountered. This is usually at mid-block locations, isolated crosswalks and where the adjacent land use is likely to generate a fairly high number of crossings, such as at transit stops.

Sign W11-2 should be used in advance of crossings or areas of high pedestrian use; sign W11-2 may be supplemented with the plaque W16-7p at a crosswalk.



Figure 5-14: Signs W11-2 and W16-7p



Pedestrian crossing signs

Textured & Colored Crosswalks

Textured crossings, using bricks or pavers, are often assumed to be more visible to drivers; there is also speculation they raise drivers' awareness through increased noise and vibration. Experience has shown that textured/colored crosswalks fade quickly and are less visible to drivers than conventional white markings, especially in the dark or in adverse weather. The texture increases vibration for pedestrians using wheelchairs or walkers, slowing them down as they cross the road.



Textured crosswalk, pedestrian view point



Drivers view of same crosswalk

Where coloring and/or texturing is used, the area where pedestrians cross must be smooth, and white lines must be used to demark the crosswalk.

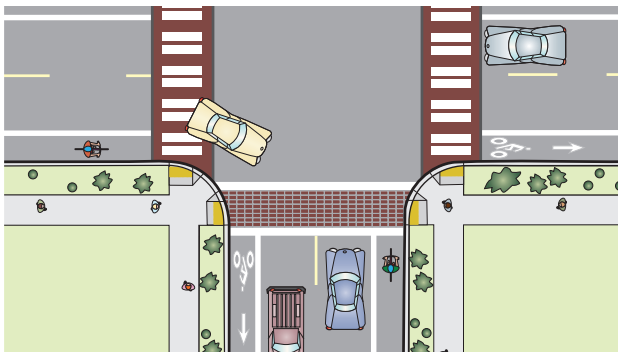

Figure 5-15: Textured crosswalk supplemented with white lines



Textured crosswalk with supplemental white markings

Coloring the pavement surrounding the crosswalk can increase visibility by increasing contrast. Conventional striped crosswalks are set in the colored area. Decorative crosswalk markings are not recommended. They are not visible to drivers and experience has shown that they do not last as long as standard white pavement marking materials.

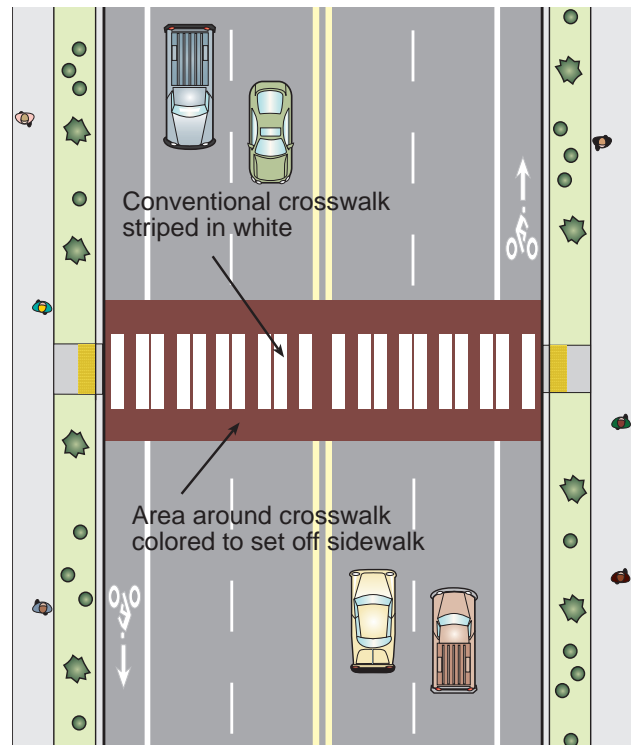
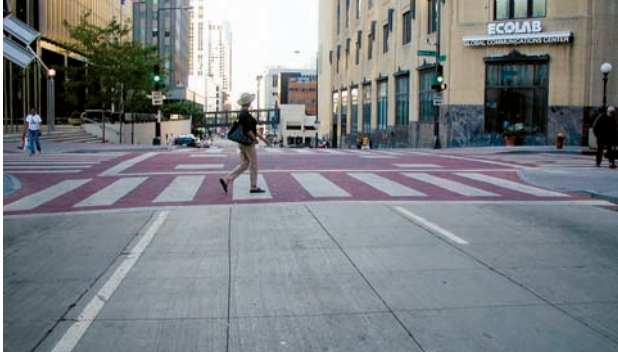

Figure 5-16: White crosswalk inset into colored pavement



White markings inset into colored pavement

Illumination

Pedestrians are disproportionately hit at night. Many crossing sites are not well lit. Providing illumination or improving existing lighting can increase nighttime safety at intersections and midblock crossings, increasing awareness by motorists.

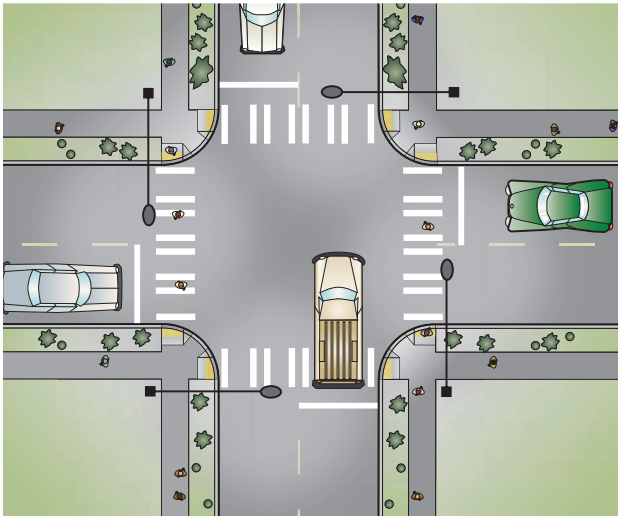

Figure 5-17: Proper illumination makes pedestrians crossing the street more visible

The vertical surface of the pedestrian should be lit. Lighting placed directly over a crosswalk illuminates the tops of the pedestrians' head, only. For guidance on crosswalk illumination see Informational Report on *Lighting Design for Midblock Crosswalks*, FHWA-HRT-08-053.

Raised Medians & Refuge Islands

These should be considered the first option on multi-lane, two way roads. On busy highways,

it can take a long time to find a gap that allows a person to cross four or more lanes of traffic in both directions. A median allows a pedestrian to cross only one direction of traffic at a time, making it much easier to find and correctly identify acceptable gaps. The crossing task is greatly simplified: the pedestrian simply looks left, waits for an acceptable gap, crosses to the median island, then looks right, and seeks a second gap. Pedestrians are less likely to take risks and try to dash all the way across if they know they only need to cross halfway.

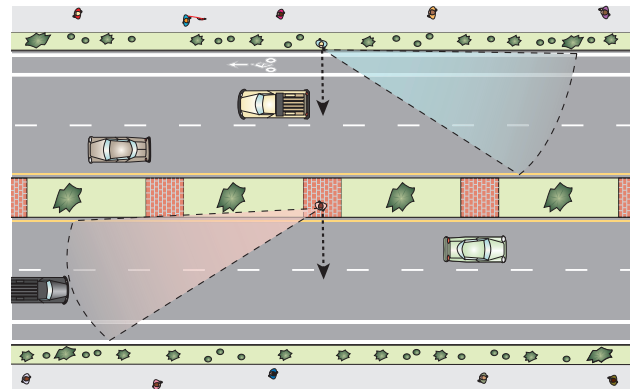

Figure 5-18: Median allows pedestrian to cross one half of the roadway at a time

To provide a usable pedestrian refuge, raised medians should be constructed with a curb no higher than used for sidewalks (6 inches-7 inches). The surface of the median should be level and smooth. If the median is landscaped, flat paved areas should be placed occasionally to provide a place to stand and wait.

When a raised median is designed for access control, with pedestrian crossings in mind, there is usually no need to mark crosswalks or provide curb cuts; it is a feature that simply allows pedestrians to cross more easily, as the law allows, as long as pedestrians yield to traffic. Marking crosswalks reverses the yield rules, and should only be considered at specific locations where a lot of concentrated crossings are expected; curb ramps and cut-throughs need to be provided where a crosswalk is marked. Midblock crosswalks are established by the appropriate road authority, and must

be approved by the State Traffic Engineer on State Highways. Curb ramps or cut throughs must also be provided at all marked crosswalks and intersections. Consult the ODOT Traffic Manual for information on marking crosswalks on State Highways.

Where it is not possible to provide a continuous raised median, refuge islands can be provided across from high pedestrian generators such as schools, park entrances, libraries, parking lots, transit stops, etc. If a raised island is placed midblock, with curb cuts and other obvious pedestrian features, a crosswalk should be marked, as the added treatments indicate to pedestrians “this is a place to cross.”

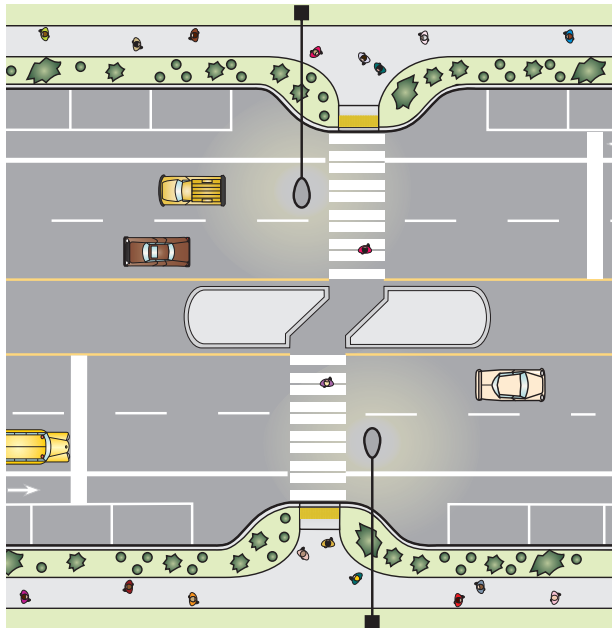

Figure 5-19: Midblock island with high visibility crosswalks, advanced stop lines, illumination and angles cut through

Refuge islands should be made as big as possible, so they are visible to drivers. Other ways to increase visibility include painting the curb yellow, providing landscaping (but not so high as to obscure pedestrians) and signing.

Cut-throughs should be at least 5 feet wide. Cut-throughs are preferred over ramps, as most islands are not large enough to comfortably fit two ramps and a 4-foot level landing between the ramps as required by ADA. One technique

to increase the likelihood a pedestrian will look at oncoming traffic in the second half of the crossing is to skew the cut-through to the right, forcing pedestrians to face oncoming traffic as they traverse the island. A 2-foot section of right-angled curb should be provided at each end to provide guidance for the blind.

In most instances, the width of a raised median or refuge island is the width of the center turn-lane, minus the minimum shy distance on each side. Minimum acceptable width for a median refuge island is 6 feet.



Median island provides mid-street refuge for pedestrians

The preferred location for a raised island, based on pedestrian demand, may conflict with vehicular turning movements if driveway accesses are present at that location. Careful negotiation with property owners may be required to ensure placement of island meets the intended goal of improved pedestrian crossings, while taking into account vehicular movements. Moving an island away from the desired crossing location may be a solution, but can be counter-productive if it's too far, as pedestrians will not use it and cross at the desired location with no island. Another option is to keep the island where needed for pedestrians, and move the driveways to allow turns to occur. On streets with diffuse crossing generators, judicious placement of high quality pedestrian crossings along the corridor can help to concentrate pedestrian crossings at the improved locations, improving roadway operations and safety. Pairing improved pedestrian crossings with transit stops is a natural choice.

Curb Extensions

Also known as bulbouts, bumpouts, neckdowns or chokers, curb extensions should be considered at all intersections where on-street parking is allowed. Curb extensions reduce the crossing distance on streets with on-street parking. Other advantages include:

- Better visibility: pedestrians can see approaching motorists and drivers can see pedestrians waiting to cross.
- Increased yielding by drivers: pedestrians standing on a curb extension are more visible, and their intent to cross the street is more obvious.
- Traffic-calming: the roadway appears narrower to drivers, even in the absence of cars parked on the street. This effect is increased when the curb extension includes features such as landscaping and street furniture, and the parking area is paved in concrete or pavers, making the road look narrower to drivers when no cars are parked.
- Slower-speed right-turns: a curb extension prevents right-turning motorists from “cutting the corner.”
- Street furniture (newspaper boxes, poles, bicycle parking, street trees, etc.) can be placed in the curb extension, outside of the pedestrian zone, as long as they don’t obscure pedestrians waiting to cross.
- Additional on-street parking: curb extensions improve visibility, allowing parking to be located closer to crosswalks.

Other techniques to increase the supply of on-street parking include:

- Carefully inventorying existing parking spots, and finding ways to increase supply by restriping.
- Moving fire hydrants from the sidewalk to the curb extension.

- Curb extensions can be elongated to serve as bus stops, reducing bus dwell time for on and off loading of passengers.



Pedestrians waiting where curb extension could be

Reducing the pedestrian crossing distance improves signal timing if the pedestrian phase controls the signal. The time saved is substantial when two corners can be treated with curb extensions. (The speed normally used for calculating pedestrian crossing time is 3.5 ft/sec). Non-signalized intersections also benefit from curb extensions: reducing the time pedestrians are in a crosswalk improves pedestrian safety and vehicle movement.

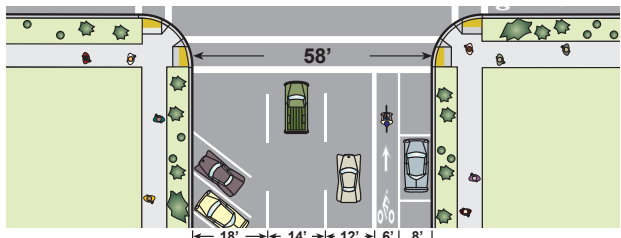

Figure 5-20: Crossing distance without curb extensions

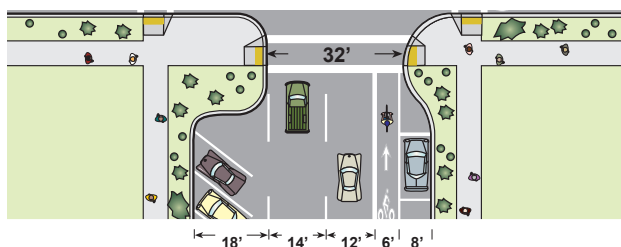

Figure 5-21: Crossing distance with curb extensions

At midblock crossings, curb extensions may be considered where there is on-street parking and there are pedestrian generators on both sides of the road. Combined with refuge islands, they greatly increase the ability of a pedestrian to safely cross a street.



Motorist yields to pedestrians at curb extension



Curb extension provides room for bike parking

In general, **curb extensions should extend the full width of the parking lane**, to increase visibility, but no more: on streets with existing or planned bike lanes, the curb extension should not extend into the bike lane.

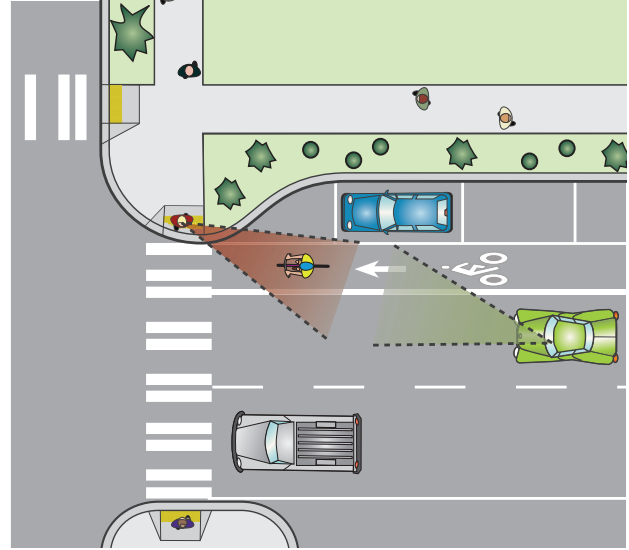

Figure 5-22: Curb extensions improve visibility of and by the pedestrian

Retrofitting curb extensions onto existing roadways often creates design challenges, as the existing sidewalk grade usually slopes at 2% toward the roadway, and the roadway slopes towards the sidewalk. A curb extension usually cannot carry the sidewalk grade out an additional 7 or 8 feet; this reduces curb exposure to below acceptable height. On retrofits, the slope of the curb extension is often reversed, following the grade of the roadway. This creates a slight valley in the curb extension. This is usually not a problem if a slight grade is created to drain standing water away.

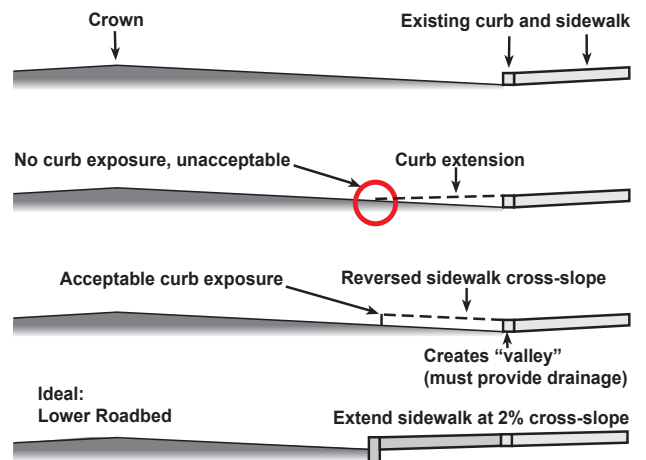

Figure 5-23: Curb extension retrofit issues

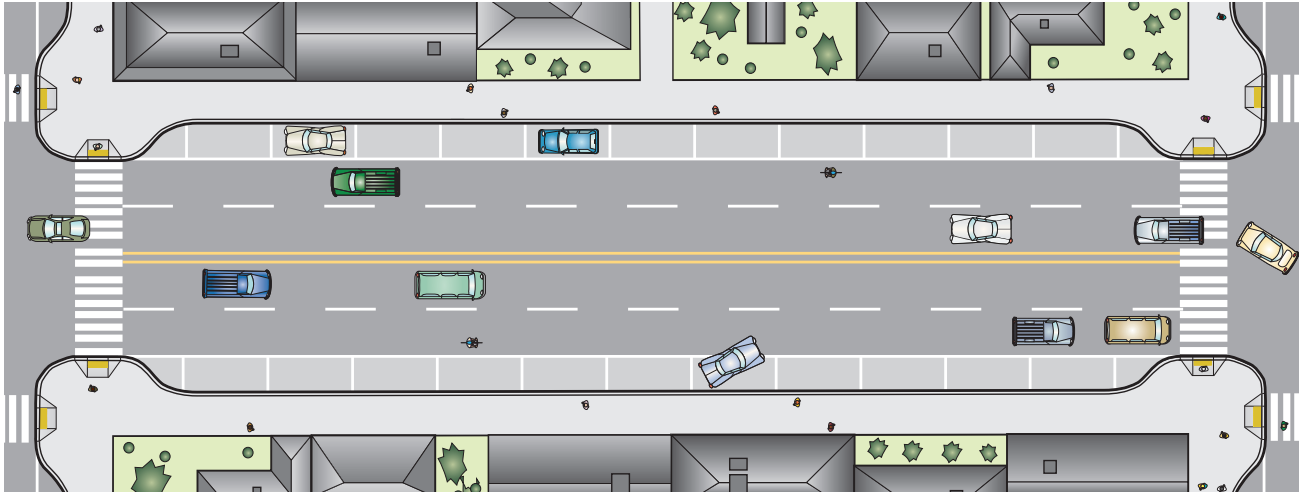

Figure 5-24: Roadway designed with curb extensions and integrated parking lanes

Solutions include slotted drains between the old curb and the extension, or placing new drains at each end of the extensions.

On new construction projects, or when the roadway and sidewalks are completely rebuilt, there is an opportunity to slope sidewalks and curb extensions correctly: a constant 2% across the sidewalk and curb extension towards the roadway. This creates parking bays that also slope at 2% towards the roadway, requiring a valley drain between the travel lanes and the parking area. Paving the parking area in concrete or pavers makes the road look narrower to drivers when no cars are parked, adding a traffic-calming element to this design.



Slotted drain at retrofit curb extension

Pedestrian Signals

A pedestrian-activated signal may be warranted where the expected number of people needing to cross a roadway at a particular location is significant and/or if it is difficult for pedestrians to find an adequate gap. Refer to the MUTCD for pedestrian signal warrants. Sight-distance must be adequate to ensure that motorists will see the light in time to stop. Advance warning signs should be installed on the approaching roadway. Signals provided for pedestrians should have the most up-to-date accessible features.

Wherever possible, the response for pedestrians should be “hot.” The signal should turn yellow then red for traffic as soon as a pedestrian pushes the button. This will encourage pedestrians to comply with the signal. If there is a substantially delayed response after a pedestrian pushes the button, the pedestrian will often seek a gap and cross against the light. Then when the light does turn red for motorists, the pedestrian is gone, increasing motorist frustration, as they don’t understand why they were required to stop.

Curb extensions and raised medians increase the effectiveness of pedestrian signals, reduce crossing times and decrease motor vehicle delay.

Rectangular Rapid Flashing Beacon (RRFB)

The Rectangular Rapid Flashing Beacon or RRFB is a pedestrian activated flashing warning beacon used to supplement pedestrian or school crossing signs at uncontrolled crosswalks. FHWA Interim Approval dated July 16, 2008 should be consulted for implementation details. The RRFB has proven to be very effective in improving stopping compliance at uncontrolled and mid-block crosswalks. In Oregon, the convention is to not provide any indication to the pedestrian about the flasher status, so that the pedestrian responds to changes in traffic, not the flasher. The RRFB should be paired with the advance stop bar on multi-lane roadways. Effectiveness improves with installation of a flasher on at the edge of the roadway and in a median.

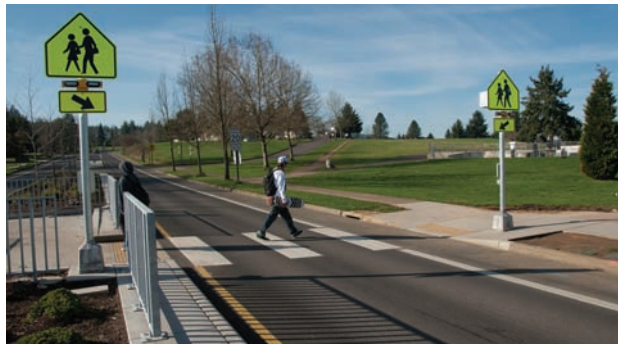

Rapid rectangular flashing beacon

Two-Step Pedestrian Signal

On busy roads, stopping all traffic long enough to let a pedestrian cross may cause undue delay if the pedestrian signal is activated frequently at peak periods. A two-step pedestrian signal minimizes delay to motor vehicle traffic while allowing pedestrians to cross conveniently. This requires a median refuge island to break the crossing into two distinct parts. Each signal is independently controlled – essentially creating two pedestrian signals across two one-way streets:

- Phase 1: pedestrian pushes button to stop traffic in one direction; traffic stops and

pedestrian crosses to median island; traffic in opposite direction is not stopped and continues to travel, uninterrupted.

- At the end of phase 1, traffic in the first direction resumes; pedestrian walks towards second crossing, which is offset to the right.
- Phase 2: pedestrian pushes button in island and stops traffic in other direction; when pedestrian has finished the second crossing, traffic resumes in the second direction.

Pedestrians must be made to walk against on-coming traffic, so they can see it hasn't stopped; pedestrians need to push the second button (a pedestrian push button on island is required). This offset also makes it possible to orient the pedestrian signals to just half the roadway, so pedestrians don't get a mixed message from a pedestrian head that is in their line of sight, but not intended for their half of the roadway.

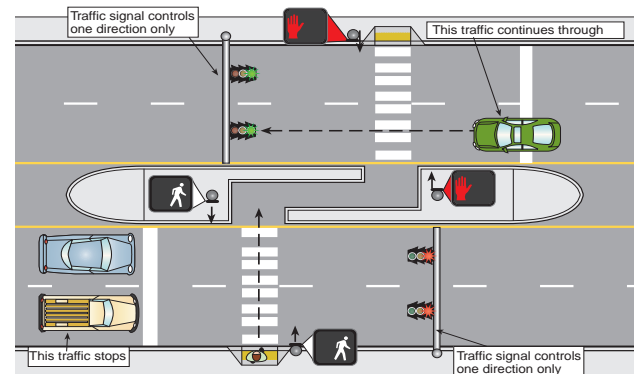

Figure 5-25: 2-step signal: pedestrian activates signal to stop near side traffic

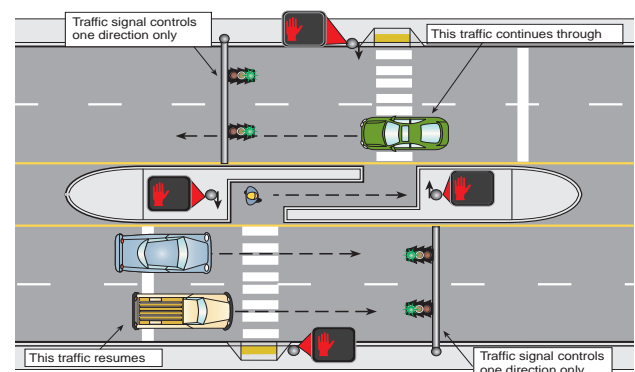

Figure 5-26: 2-step signal: pedestrian proceeds to far side crossing facing traffic

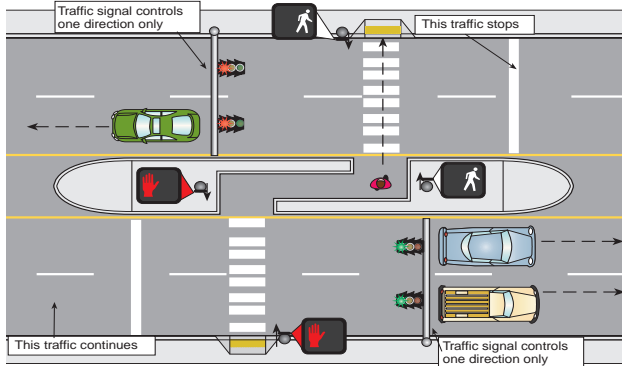

Figure 5-27: 2-step signal: pedestrian activates push button to stop far side traffic

Overcrossings and Undercrossings

Though grade-separation appears to offer greater safety, the excessive added travel distance often discourages pedestrians who want to take a more direct route. A grade-separated crossing must offer obvious advantages over an at-grade crossing. A structure that is unused because it is inconvenient or feels insecure creates a situation whereby pedestrians are at greater risk when they attempt to cross the road at-grade; drivers don't expect pedestrians to be crossing the street if they see an overcrossing.

The additional distance is substantial: 17.5 feet of clearance is required over some highways; the added depth of the structure results in a

20 feet high bridge. ADA requires ramps to not exceed a 5% grade. Twenty feet of rise at 5% requires a 400 feet ramp in level terrain, for a total additional distance of 800 feet for both sides. This can be mitigated with stairs, or a 1:12 rise with a level landing for every 2.5 feet in rise. Overcrossings are more successful where the roadway to be crossed is sunken.

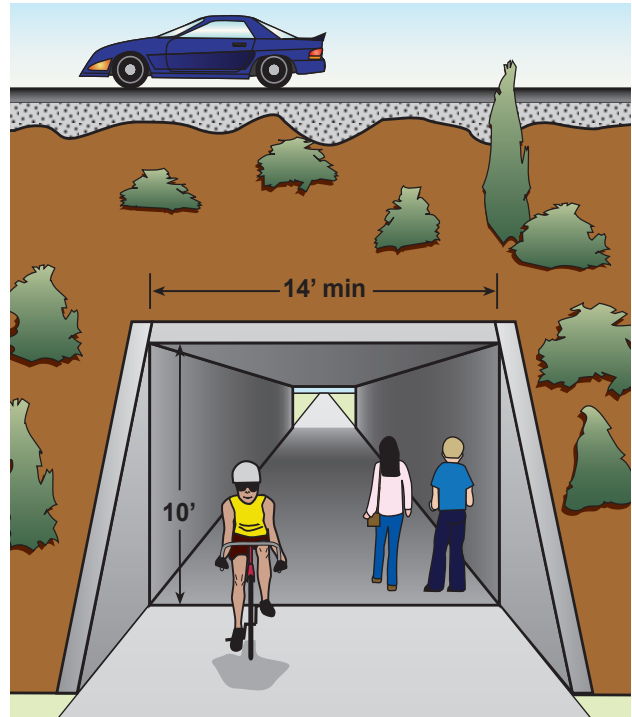
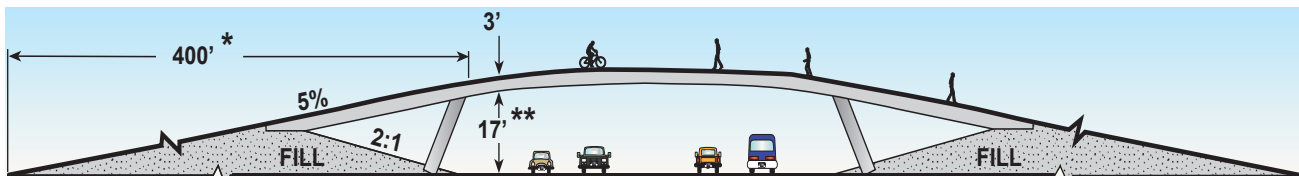
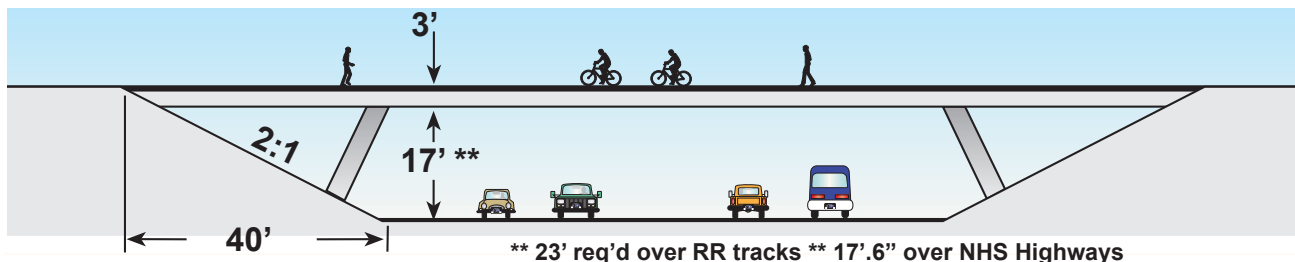

Figure 5-30: Undercrossing of elevated roadway



* not to scale ** 23' req'd over RR tracks 17.6" over NHS Highway

Figure 5-28: Pedestrian overcrossing adds a lot of travel distance when raised above a roadway



** 23' req'd over RR tracks ** 17.6" over NHS Highways

Figure 5-29: Pedestrian overcrossing reduces travel distance when roadway is lowered

Undercrossings introduce two other issues that must be addressed: security and drainage. Security can be addressed by ensuring generous dimensions, good visibility and lighting. Drainage often requires a sump pump to ensure year-round operation. Undercrossings are more successful where the roadway to be crossed is elevated. In both cases the pedestrian crossing is level. Undercrossing should be at least 10 feet high and 14 feet wide.



Pedestrian undercrossing is open and inviting

See Chapter 7 Shared-use paths for a more complete discussion on the design of bridges and undercrossings.

Other Innovative Designs

These concepts are presented as information, to help ODOT, cities and counties to come up with new solutions to street-crossing problems.

Raised Crosswalks

Raised crosswalks can render the crossing more visible, especially if the beveled edge is textured and colored. Texturing or coloring the crosswalk portion is not recommended, as this area is less visible and texture can slow pedestrians as they cross. Raised crosswalks also act as speed humps and may be used in areas where excessive speeds are a problem.

The physical design of a raised crosswalk is the same as that of a speed table. The height should

be the full height of the curb, so pedestrians can transition from the sidewalk to the crossing seamlessly; the incline of the beveled portion is a function of design speed and design vehicle.

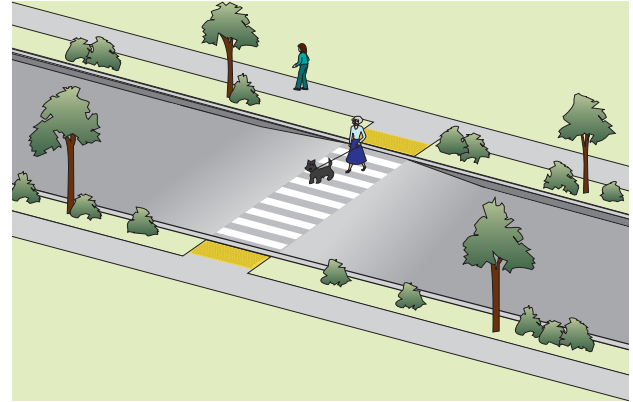

Figure 5-31: Raised crosswalk acts as speed hump



Raised crosswalk

Pedestrian Beacon

The Pedestrian Hybrid Beacon, also known as the “Hawk,” is a new form of traffic control in the 2009 MUTCD. Primarily intended for use on wide, mid- to high-speed multi-lane roadways with few crossing opportunities, at midblock locations, or minor intersections. On multi-lane roadways, an advance stop line should be provided to reduce the risk of a multiple-threat crash.



Pedestrian hybrid beacon or HAWK

Their primary purposes are to create gaps in motor vehicle traffic to let pedestrians cross without unduly adding delay. This is accomplished by using a beacon with yellow and red indicators, rather than a full green-yellow-red traffic signal. The main characteristics of a Pedestrian Beacon are:

- At rest, drivers see a dark (unlit) Beacon Head;
- At rest, pedestrians see a conventional pedestrian head indicator, set on the steady red hand (DON'T WALK), and a conventional pedestrian push button; and
- The beacon begins its sequence only after a pedestrian pushes the push button.

The sequence is as follows:

1. At rest, blank for drivers, DON'T WALK for pedestrians.
2. Pedestrian pushes button, starts the flashing yellow beacon; pedestrian indicator is still steady red hand.
3. Flashing yellow turns to steady yellow; pedestrian indicator is still steady red hand.
4. Beacon turns steady red; pedestrian indicator is steady white walking figure.
5. Beacon turns flashing/alternating red (wig-wag); pedestrian indicator turns to flashing red hand.

6. Beacon turns off and rests at blank; pedestrian indicator rests on steady red hand (Don't Walk).
7. Phase 5 is timed for a standard pedestrian crossing time of 3.5 ft/sec. The alternately flashing red wigwag indicates to drivers they may proceed after stopping and yielding to pedestrians; this shortens delay considerably.

The guidelines for pedestrian beacons identify when they can be installed at locations where full signal warrants may not be met. Consult the 2009 MUTCD for a full description of the pedestrian hybrid beacon.

CHAPTER 6: INTERSECTIONS



Large multi-lane intersections pose particular challenges for pedestrians and bicyclists, but solutions exist

Introduction

Most conflicts between roadway users occur at intersections, where travelers cross each other's path. Good intersection design indicates to those approaching the intersection what they must do and who yields to whom. Pedestrians' and bicyclists' movements are complicated by their lesser size and visibility.

This chapter is divided into intersection designs for bicyclists, intersection designs for pedestrians, and intersection and interchange designs for both pedestrians and bicyclists. These basic principles apply to all users:

- Unusual and unexpected conflicts should be avoided.
- Good intersection designs are compact.
- Simple right angle intersections are best for bicycle and pedestrian movement. The problems are more complex at skewed and multi-legged intersections.
- Free-flowing movements should be avoided.
- Access management practices should be used to remove additional conflict points near the intersection.
- Signal timing should not hinder bicycle or foot traffic with overly long waits or insufficient crossing times.

Bicyclists

These basic principles apply to bicyclists:

- Good design creates a path for bicyclists that is direct, logical and close to the path of motor vehicle traffic; only in rare cases should they proceed through intersections as pedestrians.
- Bicyclists should be visible and their movements should be predictable.
- Bike lanes should be striped to a marked crosswalk or a point where turning vehicles would normally cross them. The lanes should resume at the other side of the intersection. The bike lane stripe may be dashed prior to the crosswalk to indicate a potential conflict point to both bicyclists and drivers.

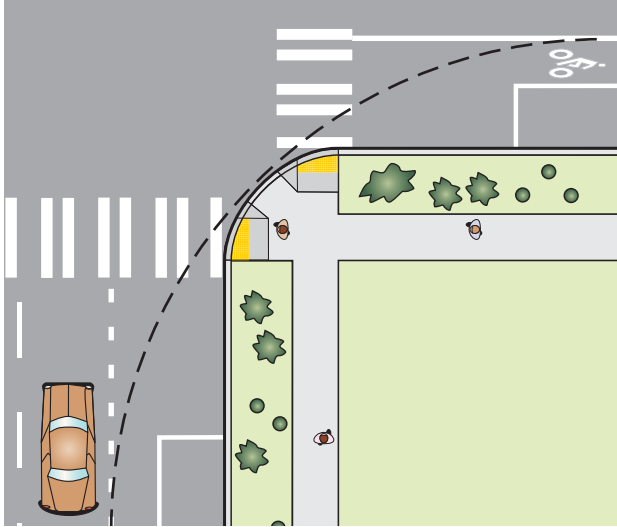

Figure 6-1: Dashing bike lane prior to intersection warns motorists and bicyclists of potential conflict

Right-Turn Lanes

Right-turn lanes should be used only where warranted by a traffic study, as they present these problems for cyclists:

- Right-turning cars and through bicyclists cross paths; and
- Right-turns are made easier, which may cause inattentive drivers to not notice bicyclists on their right.

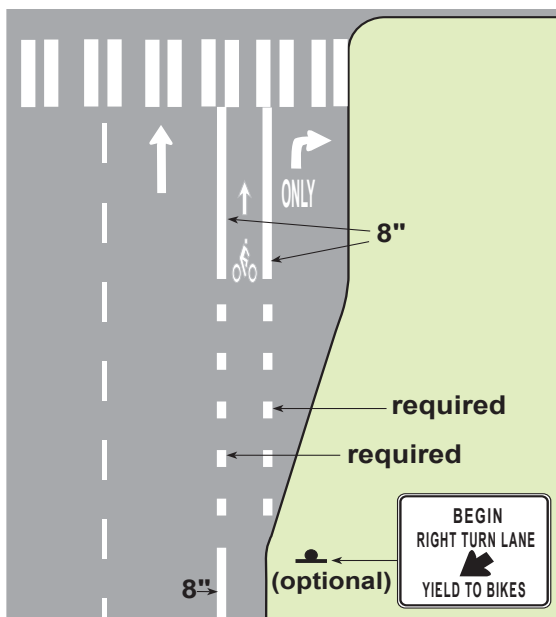

Figure 6-2: Standard right turn lane with through bike lane

The design shown above makes through bicyclists and right-turning motor vehicles cross prior to the intersection, with these advantages:

- This conflict occurs away from other conflicts at the intersection;
- The difference in speeds enables a motor vehicle driver to pass a bicyclist rather than ride side-by-side; and
- Bicyclists follow the rules of the road: through bicyclists proceed to the left of right-turning vehicles.

This design should also be used where there are currently no bike lanes approaching or beyond the intersection, for these reasons:

- This design enables bicyclists and drivers to position themselves correctly; and
- When the roadway is striped with bike lanes in the future, the intersections are already designed correctly.

Other Right-Turn Lane Designs

Not all intersections have an exclusive right-turn lane. A bike lane to the left of right turning cars should still be provided if right turn movements are heavy.

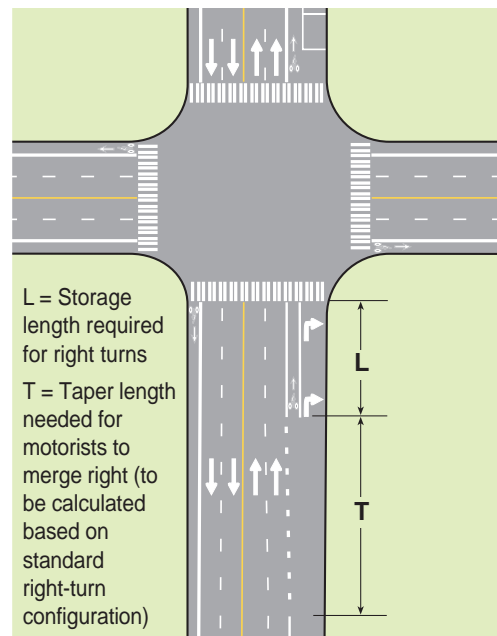

Figure 6-3: Right-turn lane developed by dropping parking lane

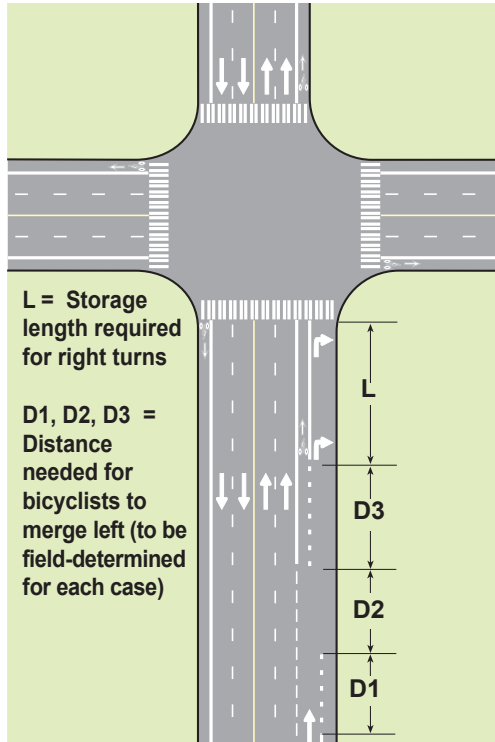

Figure 6-4: Right turn lane developed by dropping a lane

Note: This is a difficult movement for bicyclists as they must merge left and find a gap in the traffic stream.

On bike lane retrofit projects, where there is insufficient room to mark a minimum (4-foot) bike lane to the left of the right-turn lane, a right-turn lane may be marked and signed as a shared-use lane, to encourage through cyclists to occupy the left portion of the turn lane. This is most successful on slow-speed streets.

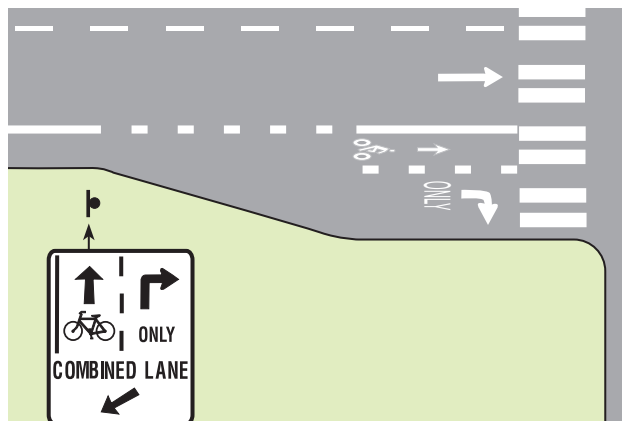

Figure 6-5: Combined right turn lane and thru bike lane



Combined right turn lane and thru bike lane

Exceptions

Heavy Right Turns

If the major traffic movement at an intersection is to the right, and the straight through move leads to a minor side street, the bike lane may be placed on the right if most cyclists are turning right. This often occurs where a highway winds through town and is routed over local streets.

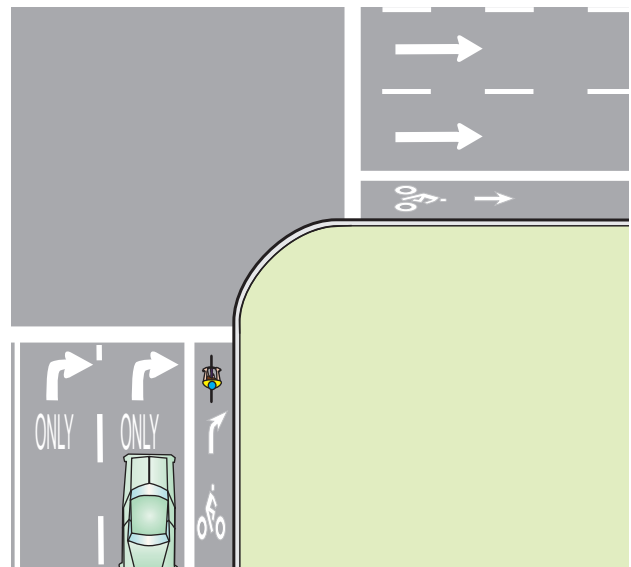

Figure 6-6: Right bike lane follows traffic flow

Tee Intersections

At a T-intersection, if the traffic split is approximately 50% turning right and 50% turning left, the bike lane should be dropped prior to the lane split so cyclists can position themselves in the correct lane; where traffic volumes are very high, a left- and right-turn bike lane should be considered.



Figure 6-7: Bike lane at T-intersection

Signals

Traffic signals are timed to accommodate smooth motor vehicle flows at a desired operational speed. In urban areas, this ranges from 15 to 45 MPH. These speeds are higher than typical bicycling speeds: 10 to 20 MPH.

Signal timing can create difficulties for bicyclists trying to maintain a constant speed. They may be able to get through two or three lights, then have to stop and wait, to start over again. This can tempt bicyclists to get a jump on a light or to run red lights out of frustration or to take advantage of their momentum.

Where bicycle use is high, signal timing should take into account the convenience of bicyclists. For example, the traffic signals in downtown Portland, Oregon are timed between 12 and 16 MPH, allowing bicyclists to ride with motor vehicle traffic.

In Copenhagen, Denmark, they have adopted the “Green Wave”. Green Wave signals are timed for bicycle travel speed, minimizing stopping.

On signals that function “on-call” (with loop detectors), these improvements can be made to;

- Placing loop detectors in bike lanes to prolong green phase when a bicyclist is passing through (the yellow phase may not allow enough time for a cyclist to cross a wide intersection);
- Increasing the sensitivity of existing loop detectors in bike lanes;
- Painting stencils to indicate to cyclists the most sensitive area of the loop;
- Placing push-buttons close to the roadway where a bicyclist can reach them without dismounting.



Stencil indicates where to position bicycle over loop detector to trip signal

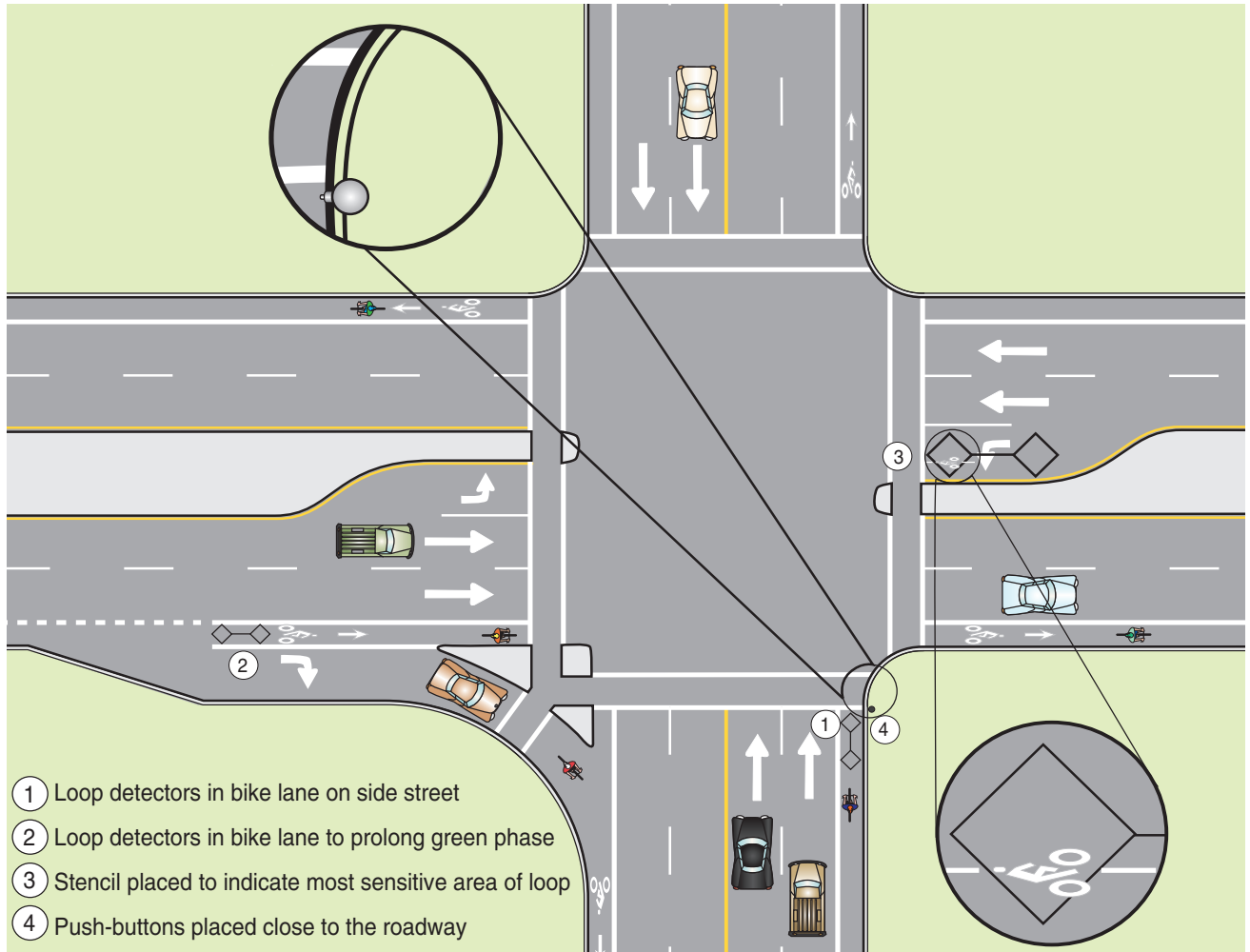

Figure 6-8: Intersection sensitive to bicycles

Pedestrians

Basic principles of intersection design for pedestrians:

- All legs of an intersection should be open to pedestrians;
 - If a crosswalk is closed for safety or capacity reasons, and there are pedestrian destinations at the closed crosswalk, every effort should be made to mitigate the closure justification and reopen the crosswalk. ORS 810.080 requires a physical barrier. Refer to the ODOT Traffic Manual for ODOT's policy on crosswalk closure.
- The pedestrian's path of travel should be direct, with minimal out-of-direction travel, and obvious to drivers;
- Pedestrians should not have to cross too many travel lanes without a refuge island available; and
- Pedestrian refuge islands should be used to decrease crossing distances and separate conflicts.

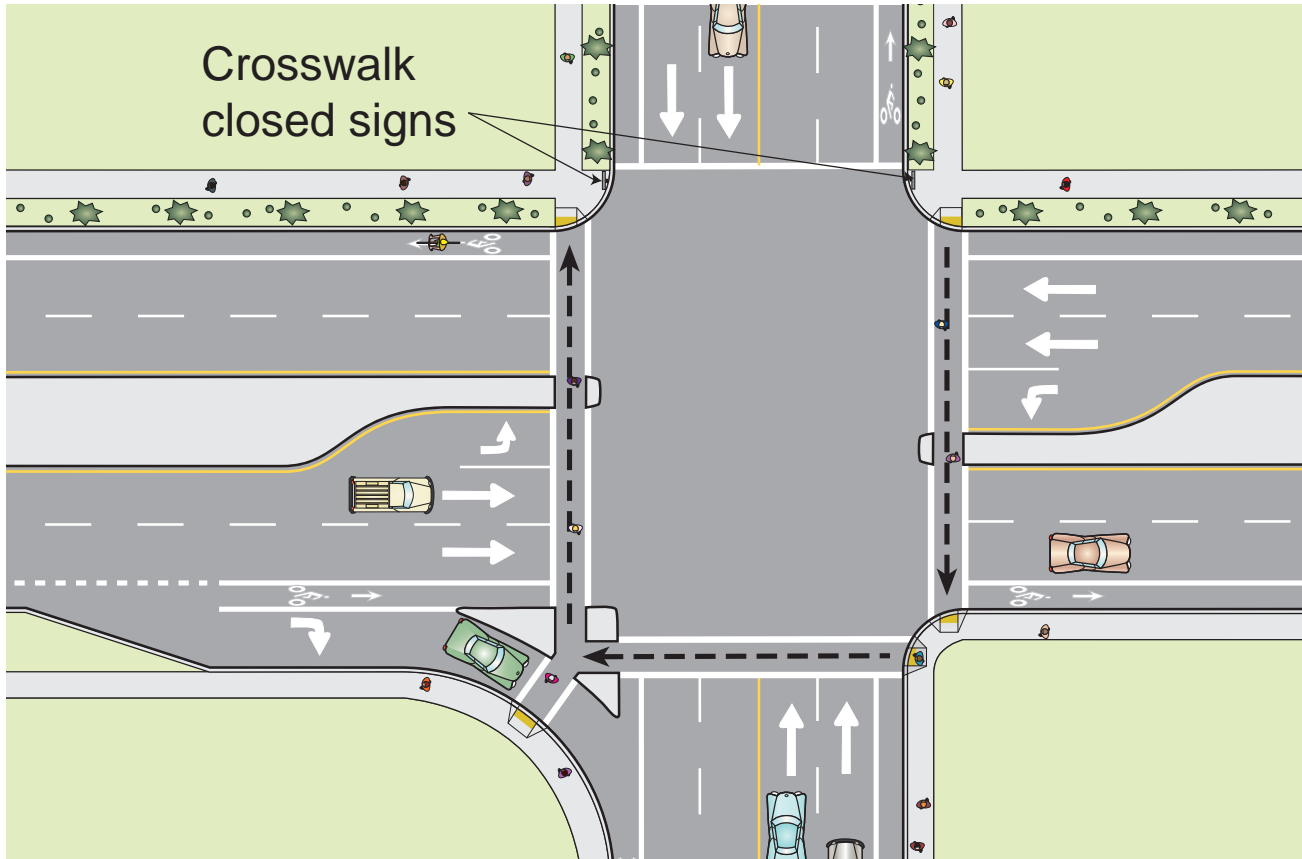

Figure 6-9: Closed crosswalk forces pedestrians to cross three streets instead of one

Minimizing crosswalk length

Crosswalks should be kept as short as possible. This can be achieved by:

- Making the radius of a corner as small as needed to accommodate design vehicles. The effective turning radius takes into account parking and bike lanes. The radius can be very tight on one-way streets where no turn movements are allowed at a corner;
- Using curb extensions on streets with on-street parking, as they make pedestrians more visible to motorists. At signalized intersections, they improve signal timing by reducing the time needed for the pedestrian phase;
- Using islands to interrupt long crosswalks; and
- Lining up curb cuts with the crosswalk.

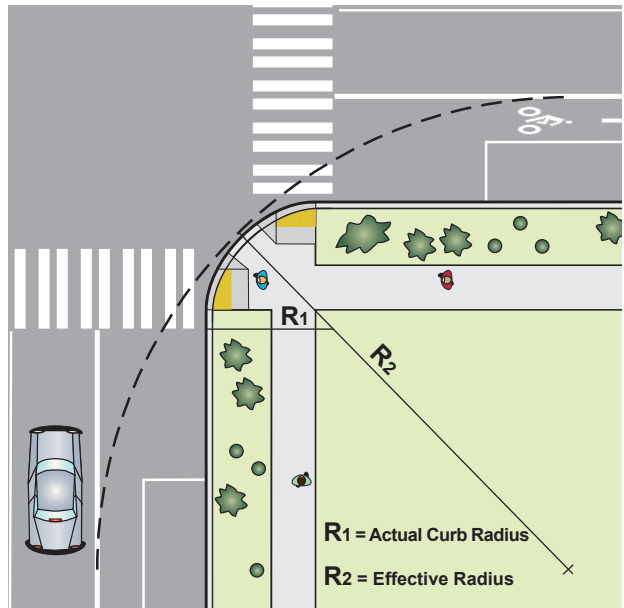

Figure 6-10: Effective vs. actual corner radius

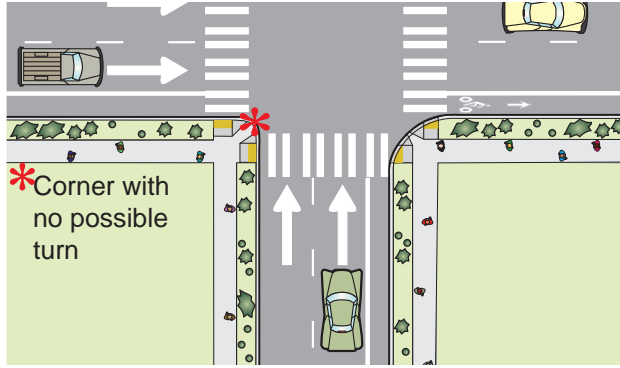

Figure 6-11: Corner with no turns can have tight radius

Truck Turning

Truck movements are an important consideration of roadway design. The needs of trucks must be balanced with the impact to pedestrians and bicyclists. In many instances prudent roadway design accommodates but does not design for trucks. Accommodation refers to the physical ability of a large vehicle to make the required turn movements: allowing large trucks to turn into the far travel lane or encroach on the bike lane, for example. This is often preferable to designing for the largest vehicle and negatively impacting curb radii, crosswalk alignment, curb ramp placement and other elements of the bicycling and walking networks.

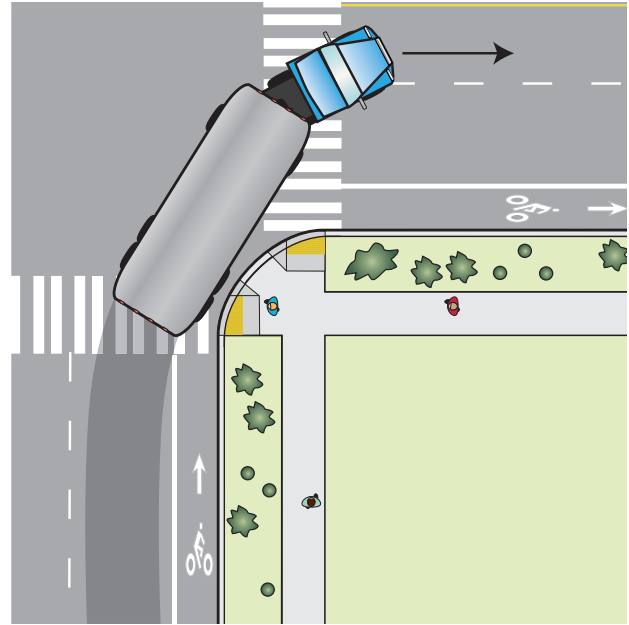

Figure 6-13: Large vehicles can be accommodated



Truck negotiating turn

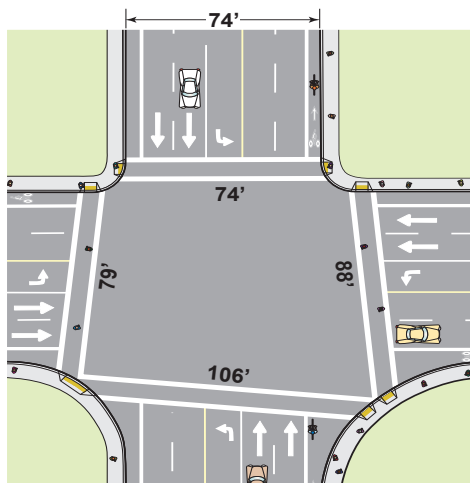

Figure 6-12: Large curb radius design impacts crossing distances, crosswalk alignment and facilitates high speed motor vehicle turns

Crosswalk Placement

There are many situations where it is difficult to determine the best location for a crosswalk, often because of skews, large radii or other complicating factors. There are three ways to approach the problem:

1. Place the crosswalk in a direct line with the pedestrians' line of travel as they approach the intersection;
2. Place the crosswalk where the distance across the roadway is shortest; or

- Place the crosswalk midway between the above two locations.

The first two approaches can yield undesirable results: the shortest distance is often in a location too far from the intersection to be obvious to drivers and pedestrians; the most direct route often creates a long crosswalk. Sometimes the best crosswalk placement is to split the difference between these two extremes, locating the crosswalk where it is visible to drivers and used by pedestrians.

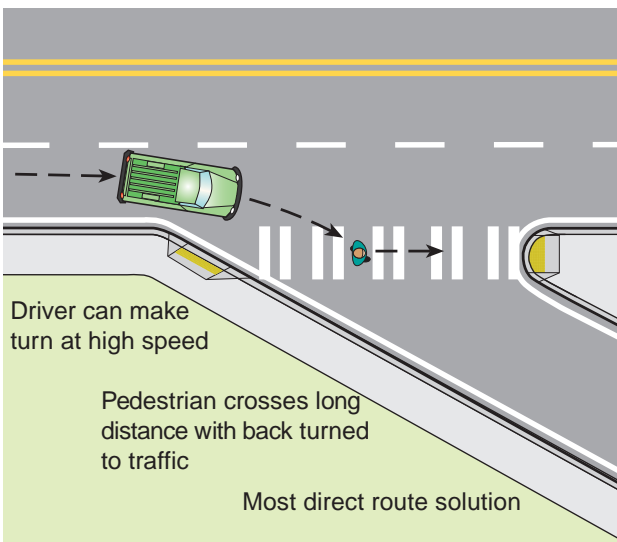

Figure 6-14: Crosswalk placed at most direct route

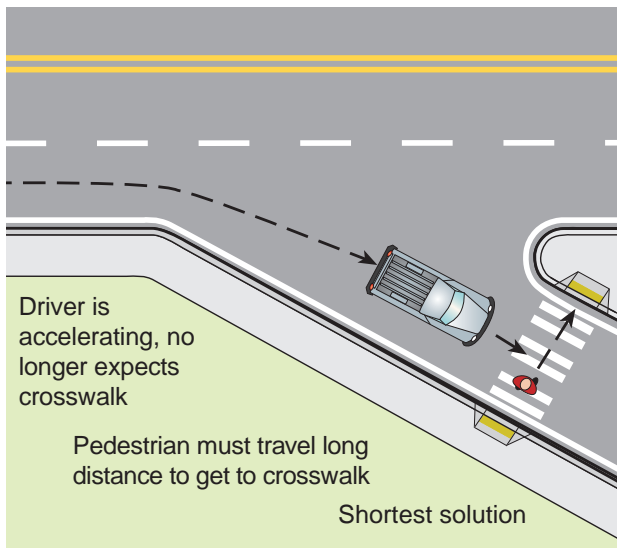

Figure 6-15: Crosswalk placed at shortest crossing point

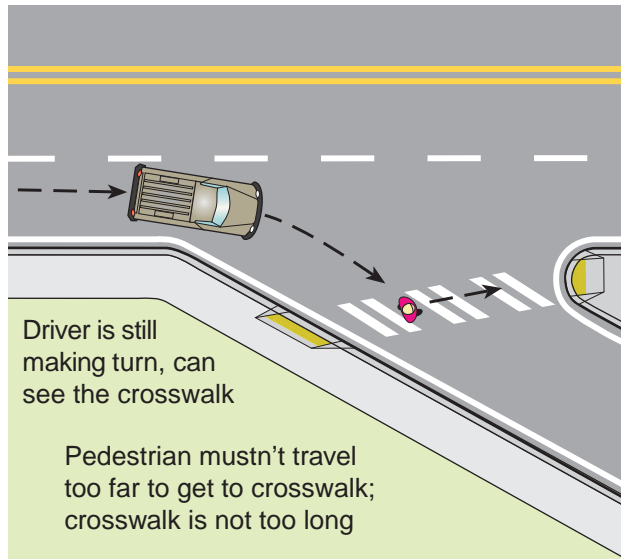

Figure 6-16: Crosswalk placed midway between direct and shortest routes

Crosswalk Markings/Materials

See Chapter 5 for information on crosswalk striping, colors and texture.

Pedestrian Signal Head Placement

All signalized intersections should have pedestrian signal heads; they should be clearly visible, placed within, or at least close to the crosswalk they control, at a height of 7 to 10 feet, so pedestrians can see them.



Pedestrian signal head in line with crosswalk

Push Button Placement

At signalized intersections, where pedestrian pushbuttons are necessary, they should be clearly visible and be placed close to the level landing at the top of curb ramps. The pushbuttons should be within 10 feet of the curb, 5 feet of the prolongation of the crosswalk, and mounted on a pole or pedestal adjacent to the crosswalk they control at a height of 42 inches. In most cases a separate pedestal is needed to fulfill these requirements; mounting two pushbuttons on one pole rarely satisfies these requirements.

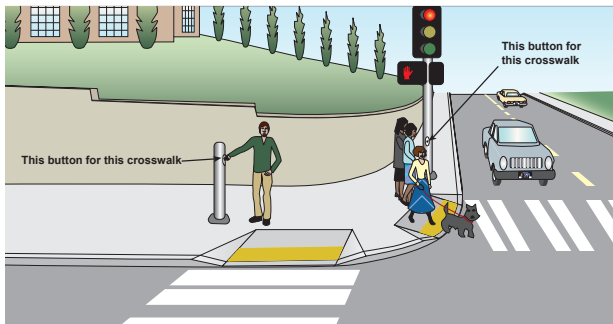

Figure 6-17: Proper pedestrian push button placement



Pushbutton placed and aligned for the visually impaired

Pushbuttons should be equipped with the most up-to-date accessibility features (vibro-tactile, audible).



Tactile pedestrian push button

Push buttons should not be used in high pedestrian use environments, such as a central business district, where the pedestrian phase should be recalled at every signal cycle.

Islands & Refuges

A median island at an intersection helps pedestrians who cannot cross all the way at one time. Islands must be at least 6 feet wide, preferably 8 feet or more, and large enough to provide refuge for several pedestrians waiting at once. For wheelchair accessibility, it is preferable to provide at-grade cuts rather than ramps.

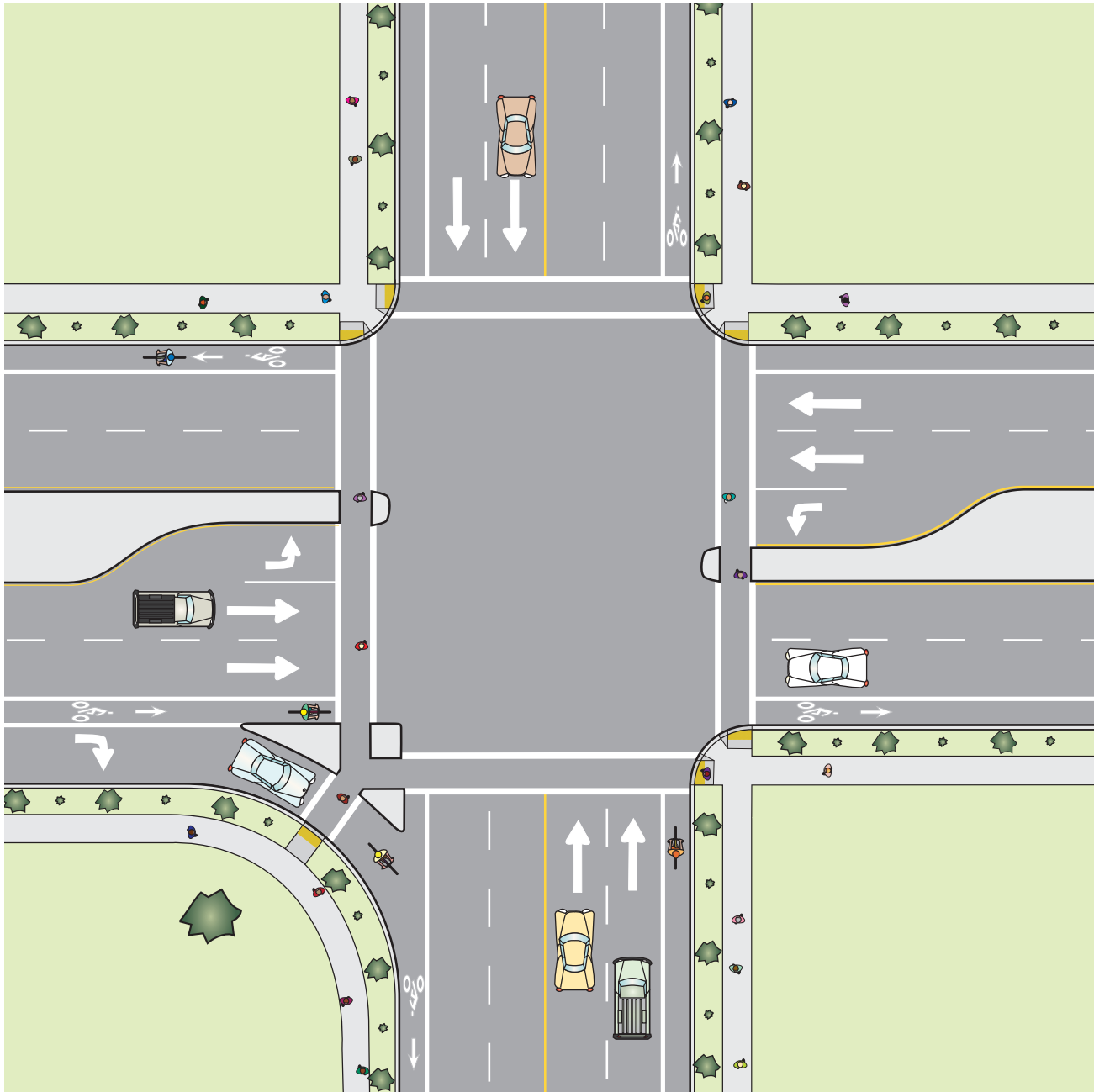

Figure 6-18: Pedestrian refuge island and medians helps separate conflicts and assists pedestrian crossings at large intersections



Cut thru pedestrian island

Right-turn lanes should be used only where warranted by a traffic study, as they present problems for pedestrians:

- The additional lane width adds to the pedestrian crossing distance;
- They can add confusion to pedestrians with vision impairments, as right-turning vehicles mask the sound of stop-and-go through traffic; and
- Right-turn moves are made easier for motorists, which may cause inattentive drivers to not notice crossing pedestrians.

Once the decision has been made to provide a right-turn lane, placing a raised island between the through lanes and the right turn lane benefits pedestrians as they:

- Allow pedestrians to cross fewer lanes at a time;
- Allow motorists and pedestrians to judge conflicts separately;
- Provide a refuge so that slower pedestrians can wait for a break in traffic;
- Reduce the total crossing distance (which provides signal timing benefits); and
- Provide an opportunity to place accessible pedestrian push-buttons.

The design of right-turn lane channelization islands is critical to pedestrian and driver safety:

- The angle of approach of right-turning cars must be such that the crossing pedestrian is clearly visible;
- The crosswalk across the right-turn-lane should be placed one car length back, allowing a driver to proceed to the intersection proper after having dealt with the potential pedestrian conflict at the crosswalk. This is accomplished by creating an island that is roughly twice as long as it is wide.
- The cut-throughs within the island must line up with the crosswalks.

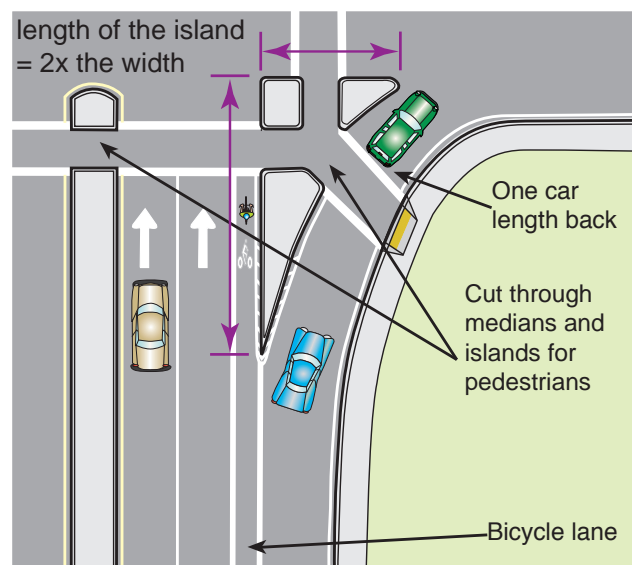

Figure 6-19: Pedestrian refuge island at right turn slip lane

Signals

Traffic signals are timed to accommodate smooth motor vehicle flows at a desired operational speed. In urban areas, this ranges from 15 to 45 MPH. These speeds are higher than typical walking speeds.

Signal timing can create difficulties for pedestrians trying to maintain a constant walking speed. They may be able to get through one or two signals, then have to stop, wait, and start over again. This tempts pedestrians to walk against the light out of frustration. Where pedestrian use is high, signal timing should take

into account the pedestrian convenience. Signal improvements for pedestrian mobility include:

- Incorporating a pedestrian phase in the signal sequence (on recall), rather than on-demand, in locations with high pedestrian use;
- Using short signal cycles to limit the time a pedestrian has to wait;
- Placing pedestrian push-buttons where they're easy to reach, next to the sidewalk, with a clear indication as to which signal the button activates (this will improve operations, as many pedestrians push all buttons to ensure that they hit the right one); and
- Motion detectors (video/infrared/microwave) that calls for a pedestrian phase when a pedestrian waits.

Signalized intersections also present many potential conflicts; pedestrians are particularly vulnerable when the walk phase is concurrent with the vehicular turn movements, especially left turns. The latter account for the greatest number of pedestrian crashes at signalized intersections. Signal improvements for pedestrian safety include:



Countdown pedestrian signal head

- Pedestrian countdown signals: let pedestrians know how much time is left to cross; this has proven effective at reducing conflicts between turning vehicles and pedestrians still in the crosswalk at the end of the crossing phase.

- A longer all-red phase: this can prevent conflicts with vehicles entering the intersection on the tail end of a yellow light and not making it to the far crosswalk before it turns to the steady walk phase for the pedestrian.
- The Leading Pedestrian Interval: (LPI) gives pedestrians a 2-5 second head start before the concurrent vehicle phase turns green; this helps reduce conflicts with pedestrians and turning vehicles, as pedestrians enter and occupy the crosswalk before turning vehicles get there. Accessible Pedestrian Signal features are essential, so pedestrians with vision impairments know when the walk indicator has come on for them.

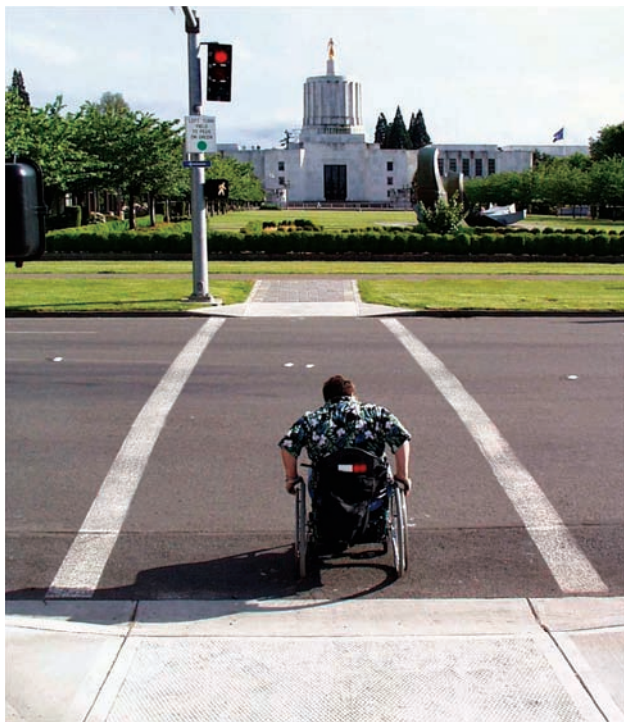

LPI: Pedestrian phase precedes motor vehicle green phase by a few seconds

- Protected left turns: This virtually eliminates left-turn conflicts, as the walk phase is not concurrent with left-turning vehicular movements.

Issues for Pedestrians and Bicyclists

Skewed Intersections

Skewed intersections are generally undesirable and introduce complications for bicyclists and pedestrians:

- Bicyclists and pedestrians approaching from an acute angle are not very visible to motorists;
- The crosswalks are longer, which lengthens the pedestrian phase at a signalized intersection; and
- The path a bicyclist must follow may not be evident.

To alleviate these concerns, several options are available:

- Every reasonable effort should be made to design the intersection closer to a right angle;
- Pedestrian islands should be provided if the crossing distance is excessive; and
- Bike lanes may be striped with dashes, or colored, to guide bicyclists through a long undefined area.

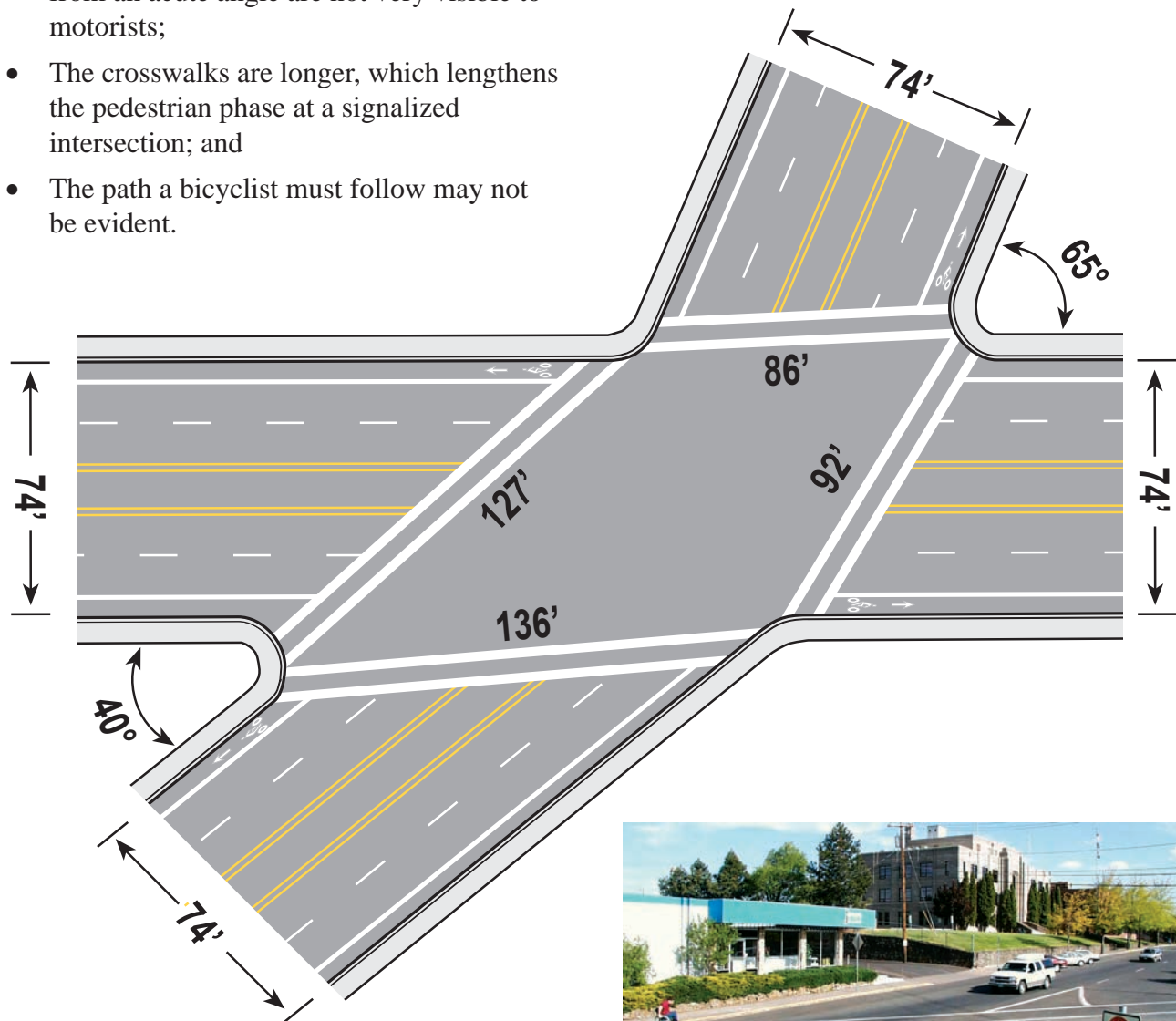

Figure 6-20: Skewed intersection increases crossing distances



Skewed intersection results in long crosswalk and increased pedestrian exposure

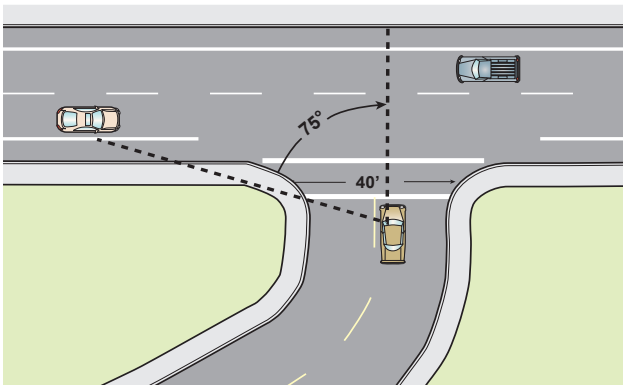
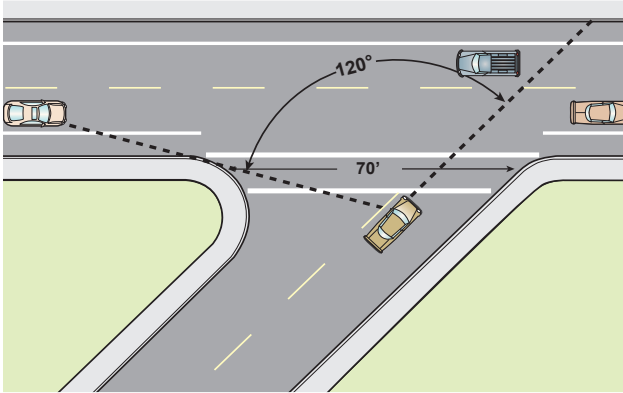

Figure 6-21: Squared intersection improves visibility



Formerly skewed intersection realigned to right-angle



Blue bike lane thru skewed intersection

Multi-Leg Intersections

Multi-leg intersections are generally undesirable and introduce complications for bicyclists and pedestrians:

- Multiple conflict points are created as motor vehicles arrive from several directions;
- The visibility of cyclists and pedestrians is poor as they are not seen by many approaching vehicles;
- The unpredictability of motorists, cyclists and pedestrians is increased;
- Pedestrians and bicyclists must cross more lanes of traffic and the total crossing distance is great; and
- At least one leg will be skewed.

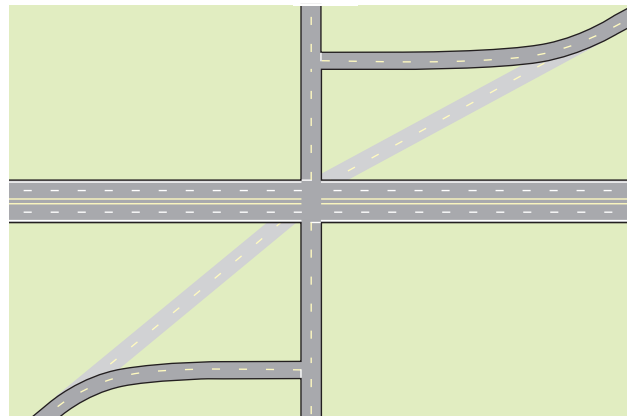

Figure 6-22: Multi-legged intersection reconfigured

To alleviate these concerns, several options are available:

- Every reasonable effort should be made to design the intersection so that only two roads cross at a given point. This is accomplished by removing one or more legs from the major intersection and creating a minor intersection further downstream;
- One or more of the approach roads can be closed to motor vehicle traffic;
- Innovative designs such as roundabouts should be considered at complex intersections;

- Pedestrian islands should be created if the crossing distance is excessive; and
- Bike lanes may be striped with dashes, or colored, to guide bicyclists through a long undefined area.

Dual Right-Turn Lanes

This situation is particularly difficult for bicyclists and pedestrians. Warrants for dual turn lanes should be used to ensure that they are provided only if absolutely necessary. The design for simple right-turn lanes allows bicyclists and motorists to cross paths in a predictable manner, but the addition of a lane from which cars may also turn adds complexity: some drivers make a last minute decision to turn right from the second turn lane without signaling, catching bicyclists and pedestrians unaware and higher speed turns are facilitated.

Users should be guided to areas where movements are more predictable, so bicyclists, pedestrians and motorists can tackle one conflict at a time, in a predictable manner.

Four possible ways to mitigate for the effect of dual right-turn lanes are:

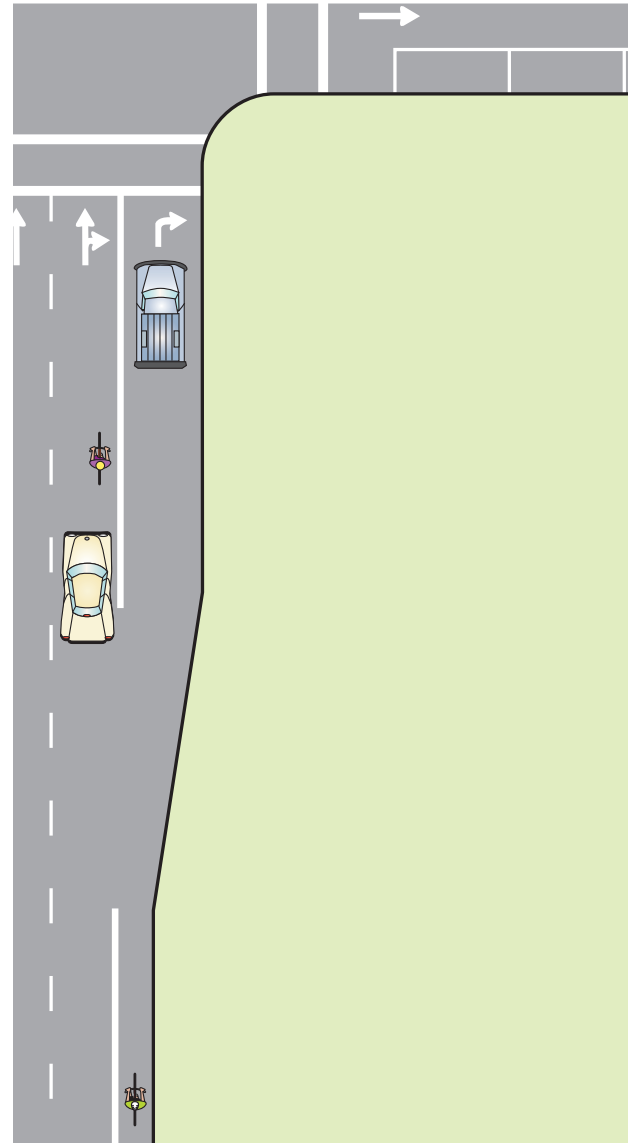

Figure 6-23: Option 1 - Drop bike lane prior to intersection

1. This design allows cyclists to choose a path themselves by dropping the bike lane prior to the intersection (this is the AASHTO recommendation).

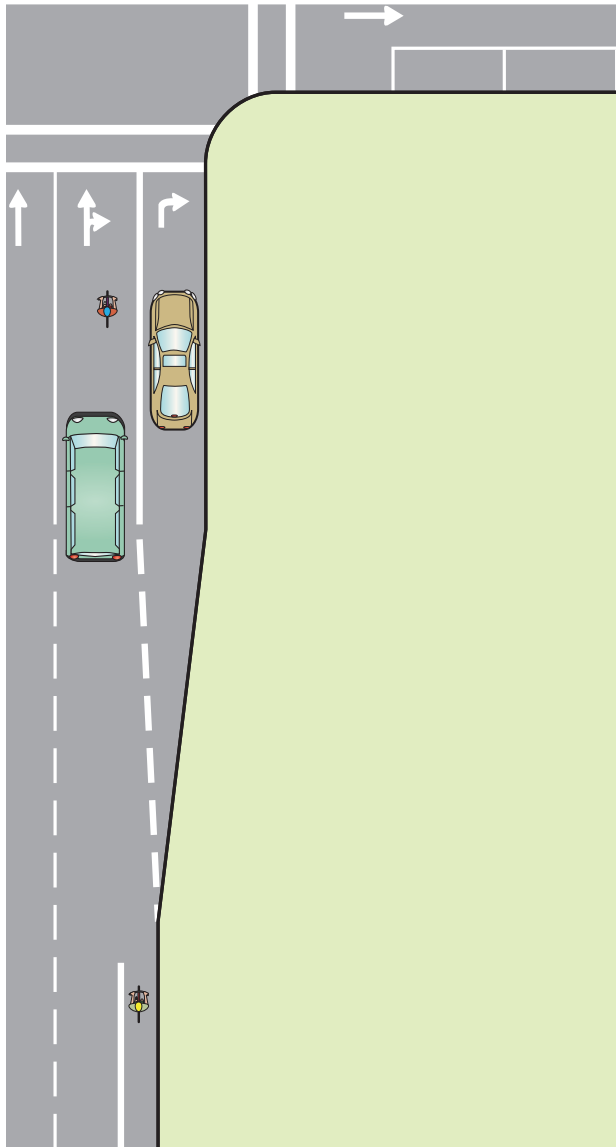

Figure 6-24: Option 2 – Encourages bicyclist to take thru-right lane

2. This design encourages cyclists to share the optional through/right-turn lane with motorists.

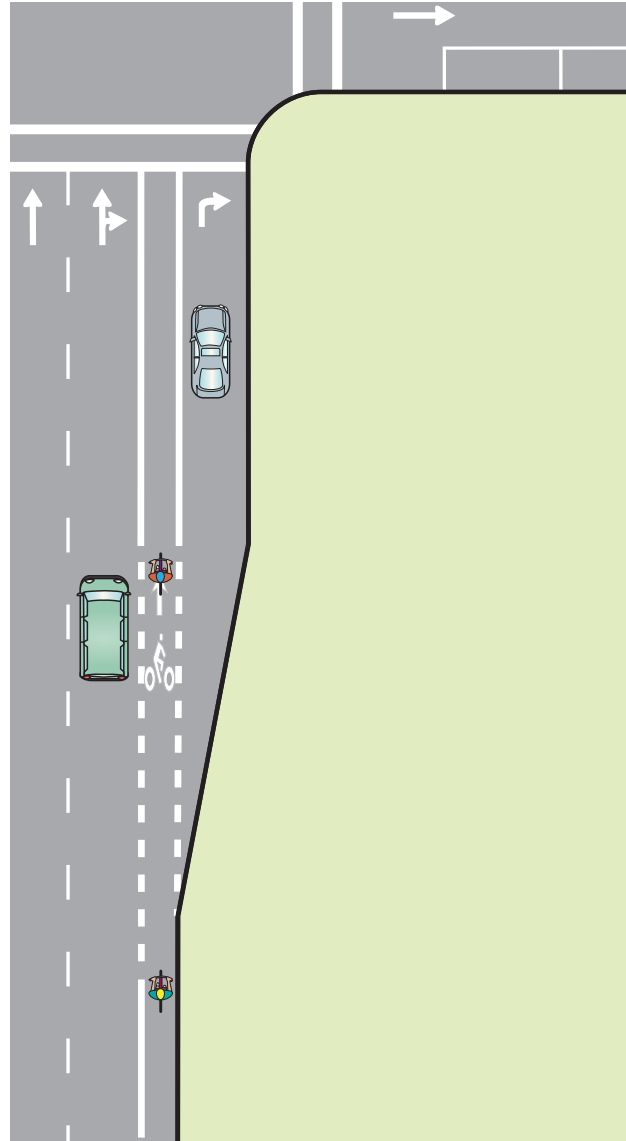

Figure 6-25: Option 3 - Preserves dedicated bike lane

3. This design guides cyclists up to the intersection in a dedicated bike lane.

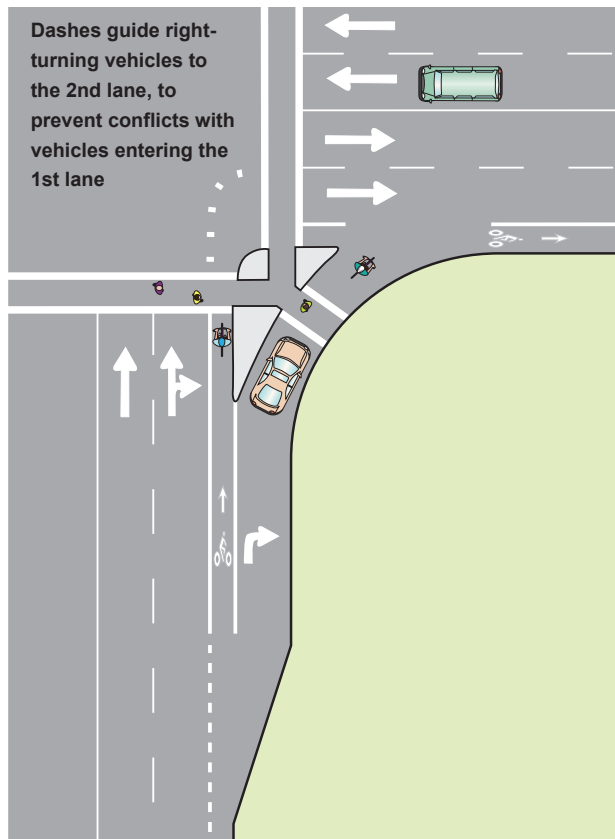

Figure 6-26: Option 4 – Addition of pedestrian island

4. This design places an island between the right-turn lane and the optional through/right turn lane. This creates a more conventional intersection, separating the conflicts. This design is also better for pedestrians, as the island provides a refuge.

Engineering judgment should be used to determine which design is most appropriate for the situation.

Modern Roundabouts

A roundabout is a type of intersection commonly used around the world; roundabouts are now gaining acceptance in this country. Modern roundabouts should not be confused with small traffic-calming circles or large rotaries, which are often signalized. Early roundabout designs were often unsuccessful for several reasons, mainly:

- They were too small (creating difficulties for trucks);
- They were too large (encouraging high speeds);
- The right of way was not clearly defined (causing confusion and collisions); or
- Pedestrians were allowed access to the middle of the roundabout.

Modern roundabouts have several distinctive features:

- Deflection which forces slow motor vehicle traffic speeds, but that allows movement by trucks;
- A landscaped visual obstruction that obscures the driver's view of the road ahead, to discourage users from entering the roundabout at high speeds;
- Clearly established right of way: drivers entering the roundabout yield to drivers already in the roundabout;
- Splitter islands, to force drivers to turn right, and to provide a refuge for pedestrians; and
- No pedestrian access to the center island, which should not contain attractions.

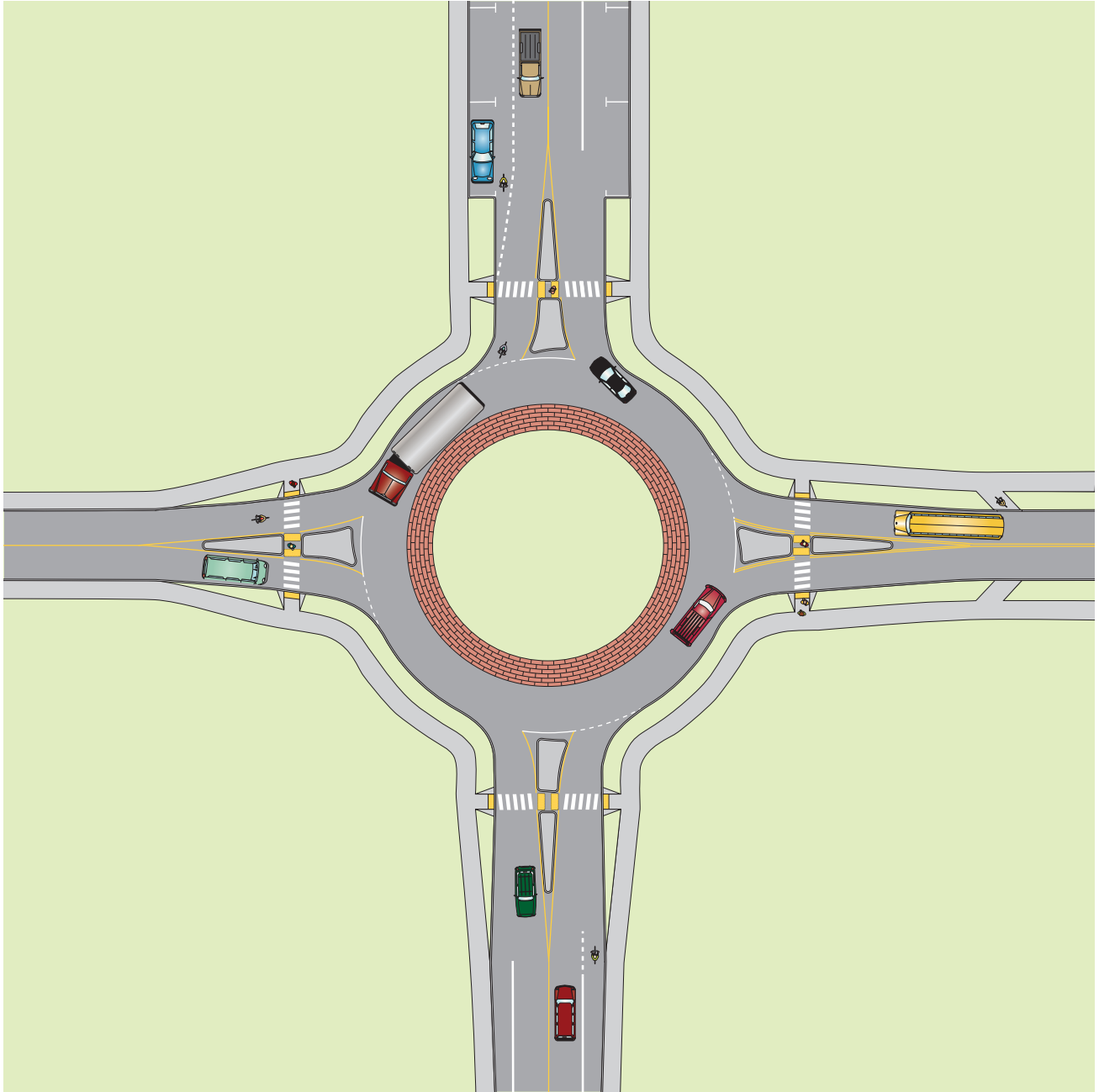

Figure 6-27: Modern roundabout



Modern roundabout in suburban context

One major advantage of roundabouts is the reduced need for additional travel lanes (signals create stop-and-go conditions, resulting in a need for extra travel lanes to handle capacity at intersections). Other advantages include:

- Reduced crash rates;
- Reduced severity of injuries (due to slower speeds);
- Reduced long-term costs (compared to traffic signals, which require electrical power); and
- Reduced liability by transportation agencies (there are no signals to fail).



Pedestrian crossing to splitter island at roundabout

Advantages of roundabouts for bicyclists and pedestrians:

- The reduced need for travel lanes enables the right-of-way to be used for bicycle and pedestrian facilities;
- Pedestrians have to cross only one or two lanes of traffic at a time, in clearly marked crosswalks;
- Motor vehicle operators negotiate the intersection at speeds closer to that of bicyclists; and
- Improved midblock crossing opportunities if the number of travel lanes can be reduced.



Bicyclist in circulating roadway at roundabout

Disadvantages for pedestrians and bicyclists:

Even though drivers must yield to pedestrians in crosswalks, this doesn't always happen; the absence of signals may have the following consequences:

- Traffic flowing more evenly may reduce pedestrian crossing opportunities as fewer gaps are created;
- Pedestrians with impaired vision may have difficulty finding traffic gaps, especially the blind who depend on traffic sounds to ensure traffic has stopped;
 - As mitigation, pedestrian signals can be added at special sites;
- Bicyclists must share the road and occupy a travel lane; by riding too far to the right,

they risk being cut off by vehicles leaving the roundabout in front of them; and

- Multi-lane roundabouts are more challenging, because it's harder to control speed through deflection; at low traffic volumes, a driver can enter from the outside lane, cut across the inside lane in the circulating roadway and exit at high speed from the outside lane.

Roundabout designs for pedestrians and bicyclists:

The following design principles help ensure roundabouts work well for pedestrians and bicyclists:

- Slow speeds provided by deflection, with constrained entries, narrow circulating roadway and truck apron;
- Simple, single lane, throughout;
- Well-defined pedestrian crossings, one car-length back from yield line;
- Splitter islands to allow pedestrians to cross one lane at a time; and
- Bike lane dropped on approaches to encourage cyclists to enter the roundabout with traffic and ride in the circulating roadway. The bike lane should be dropped about 30-50 feet prior to the entry lane crosswalk, and dashed for approximately 30 feet. A ramp should be provided where the dashes begin to allow cyclists to use the sidewalks and crosswalks to negotiate the roundabout, if they so prefer.

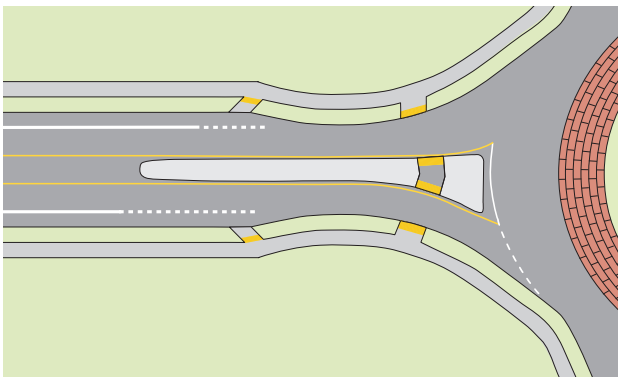

Figure 6-28: Bicyclist exit ramp detail



Bicyclist using exit ramp to access sidewalk

Interchanges

Introduction

Freeways in urban areas can present barriers to pedestrian and bicycle circulation. Interchanges can be obstacles to walking and bicycling if they are poorly designed. Pedestrians and bicyclists should be accommodated on the intersecting and parallel local roads and streets.

In rural areas, traffic volumes are usually low, little pedestrian use is expected, and recreational and touring bicyclists are usually experienced enough to make their way through an interchange. Shoulder widths through interchanges should be wide enough for bicycle and occasional pedestrian use. At interchanges with services such as restaurants, motels and stores, sidewalks, crosswalks and other pedestrian features are expected and should be provided.

In urban and suburban areas, pedestrians and bicyclists of all skill levels travel on the intersecting cross-streets. Well designed interchanges provide safe and convenient passage for non-motorized traffic.

To alleviate conflicts, more non-interchange crossings of freeways should be provided, with these advantages for bicyclists and pedestrians:

- Bicyclists and pedestrians can cross the freeway at locations where there are no conflicts with vehicles entering and exiting freeway ramps; and
- The additional crossings will relieve some motor vehicle traffic from the interchanges, making it easier for bicyclists and pedestrians who must cross at these locations.

Basic Principles

The critical areas for pedestrian and bicyclist safety, access and convenience are at the freeway ramps, where freeway traffic interacts with local traffic. The interface between the ramps and the local cross-streets must be designed so drivers understand there will be conflicts, and they should reduce their speeds to appropriate urban speeds, for example from 65 to 25 MPH.

Designs that encourage high speed and/or free-flowing motor vehicle traffic movements are the most difficult for pedestrians and bicyclists to negotiate safely and comfortably. Conversely, designs that provide safe and convenient pedestrian and bicycle passage may require some slowing or stopping of motor vehicle traffic.

It is important to consider both convenience and safety when accommodating pedestrian and bicycle travel near interchanges. The issue of safety becomes moot if facilities are not used because of perceived inconvenience. The expected path of pedestrians and bicyclists must be obvious and logical, with minimal out-of-direction travel and grade changes.

All potential pedestrian and bicycle movements should be accommodated. Closing a crosswalk should only be considered as a last resort.

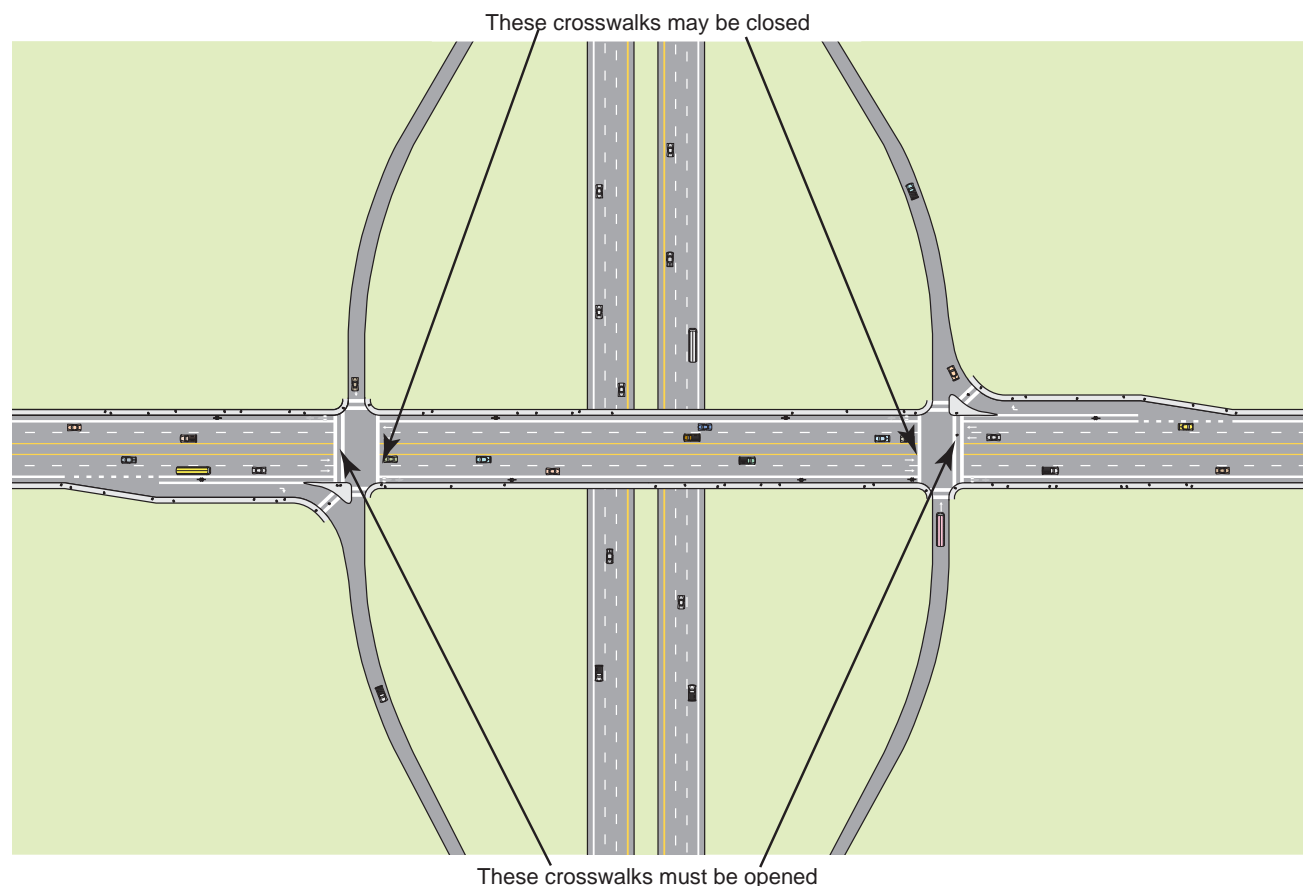

Figure 6-29: Pedestrian and bicyclist accessible urban freeway interchange with right angle approaches

However, the two crosswalks across the cross-street on the inside of the interchange may be closed, as there should be no pedestrian-accessible destinations within the interchange area; the two outer crosswalks must be open to facilitate crossings. Continuity of sidewalks and bike lanes must be provided to ensure linkage with existing facilities beyond the intersection.

In most urban and suburban settings, the appropriate pedestrian facilities are sidewalks, and the appropriate bicycle facilities are bike lanes. Sidewalks should be located on both sides of the intersecting local streets, and should be wide enough to facilitate two-way pedestrian travel. Pedestrians should have access to all 4 quadrants of the interchange, especially when destinations such as restaurants or mini-marts are present. Bike lanes must be placed on both sides of the roadway to allow bicyclists to ride with traffic. Higher design standards should be considered under these special circumstances:

- Sidewalks should be at least 8 feet wide when placed on only one side of the road, if sidewalks are not provided on the other side due to conflicts; this situation should be avoided if possible.
- Sidewalks should be at least 10 feet wide if they are intended for joint use by pedestrians and bicyclists; this situation should be avoided if possible.

Guidelines

At-Grade Crossings

Connecting access ramps to local streets at a right angle makes it easier for pedestrians, bicyclists and motorists; the intersection of the ramp and the street should follow the principles of good urban intersection design outlined earlier in this chapter. This interface should be designed as half a regular urban intersection, preferably signalized. The main advantages are:

- The distance that pedestrians and bicyclists must cross at the ramps is minimized;

- Signalized intersections stop traffic; and
- Visibility is enhanced.

Where large truck turning movements must be accommodated, compound curves reduce the distance for pedestrians at crosswalks.

The use of traffic islands can help create pedestrian refuges. Pedestrians won't have to cross too many lanes of traffic at once, which helps improve signal timing. Illumination ensures good nighttime visibility.

Interchanges that use a rural design create more difficult crossing movements for pedestrians and bicyclists, as motor vehicle speeds are higher and movements are less restricted. Configurations with free-flowing right turns and dual left- or right-turns are difficult for pedestrians and bicyclists to negotiate safely. They are particularly vulnerable where a high-speed ramp merges with a roadway.

If these configurations are unavoidable, mitigation measures should be sought. Special designs should be considered that allow pedestrians and bicyclists to cross ramps in locations with good visibility and where speeds are low.

Grade-Separated Crossings

Grade separation should be considered where it is not possible to accommodate pedestrians and bicyclists at grade. Grade-separated facilities are expensive; they add out-of-direction travel and will not be used if the added distance is too great. This can create a potentially hazardous situation if pedestrians and bicyclists ignore the facility and try to negotiate the interchange at grade with no sidewalks, bike lanes or crosswalks.

A separated path provided on only one side of the interchange can lead to awkward crossing movements:

- Pedestrians must cross prior to the interchange (signs should be used to direct them at the nearest signalized crossing); and

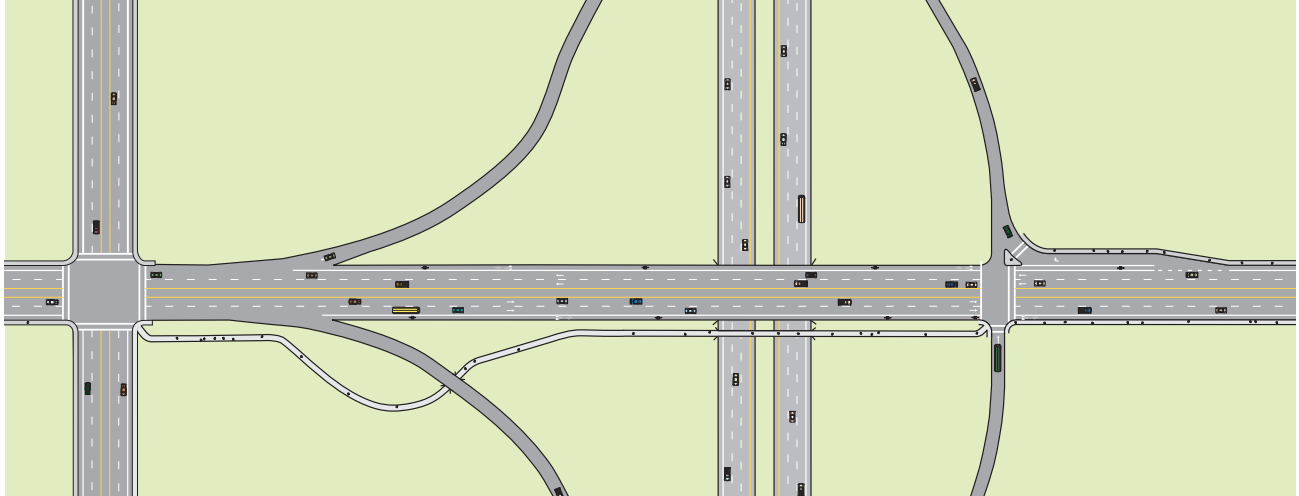

Figure 6-30: Freeway interchange with separated pedestrian and bicyclist path to avoid high speed conflicts

- Some bicyclists will be riding on a path facing traffic, creating difficulties when they must cross back to a bike lane or shoulder (clear directions must be given to guide bicyclists' movements when inconsistent with standard bicycle operation).
- Bicyclists should be able to proceed through the intersection in a straight line; and
- Motor vehicles merging to and from freeway on/off ramps should be required to yield to through cyclists.

To ensure proper use by pedestrians and bicyclists, structures must be open, with good visibility - especially undercrossings. Opportunities to provide direct links to destination points should be sought if they offer less travel distance than following the roadway alignment.

Single-Point Urban Interchange (SPUI)

The Single Point Urban Interchange is gaining favor for urban locations because of the reduced need for right-of-way. It can be made accessible to pedestrians and bicyclists by following these principles:

- Each vehicular movement should be clearly defined and controlled;
- Exit and entry ramps should be designed at close to right angles;
- Pedestrian crossings should be visible and easily identifiable;
- Pedestrians should not be required to cross more than one or two lanes at a time;

The SPUI works reasonably well for pedestrians and bicyclists if the intersection is that of a local thoroughfare and a freeway; pedestrian and bicyclists need to be accommodated only on the cross-street, not the freeway. If a SPUI is used for the grade-separated intersection of two surface streets, which accommodate pedestrians and cyclists, then the SPUI design is not effective, as pedestrians and cyclists on one of the streets will be in a freeway-like environment, with free-flowing exiting and merging ramps.

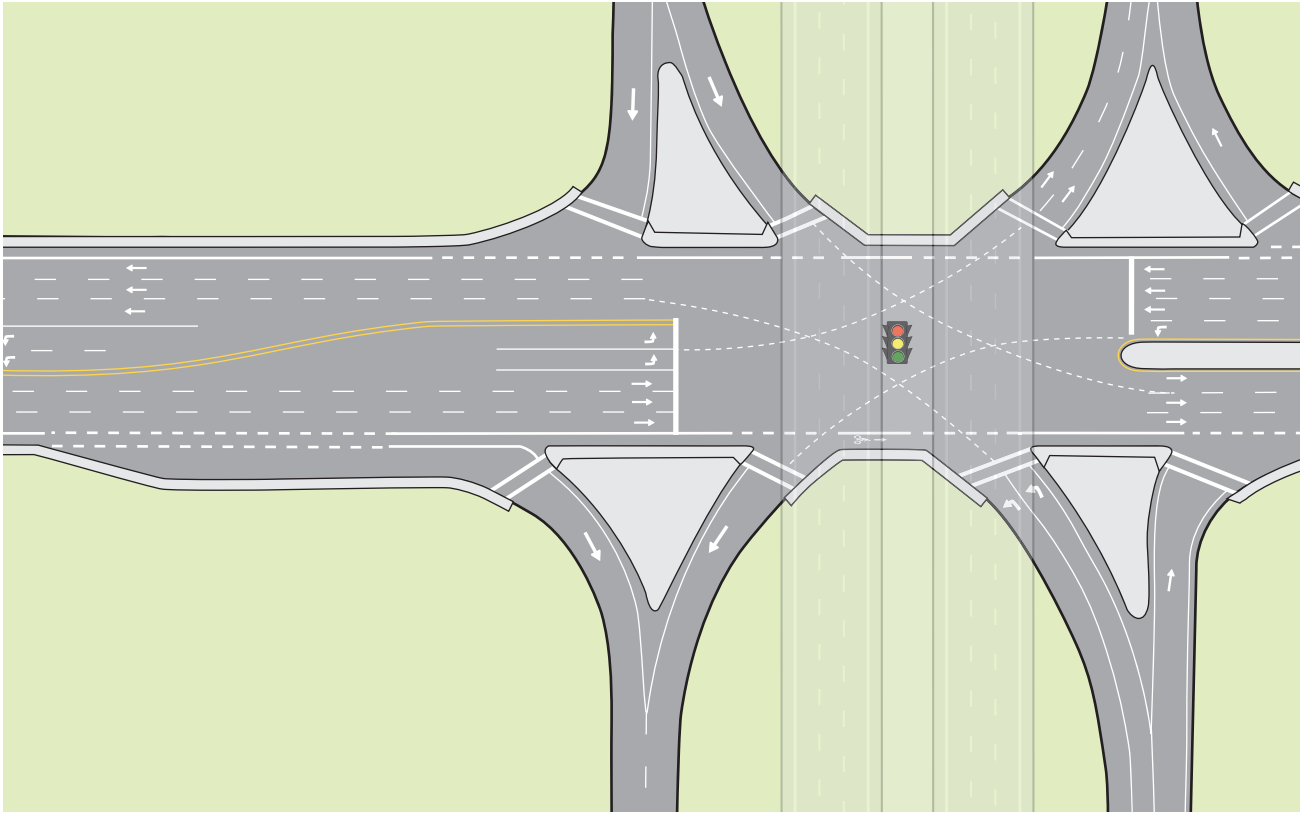

Figure 6-31: Single Point Urban Interchange (SPUI) with pedestrian and bicyclist access

Merging & Exit Lanes

While bike lanes and sidewalks are not appropriate on limited access freeways, they are common on urban parkways, which often have freeway-style designs such as merging lanes and exit ramps rather than simple intersections. Traffic entering or exiting a roadway at high speeds creates difficulties for bicyclists and pedestrians. The following designs help alleviate these difficulties.

Right-Lane Merge

It is difficult for cyclists and pedestrians to traverse the undefined area created by right-lane merge movements, because:

- The acute angle of approach reduces visibility;
- Motor vehicles are accelerating to merge into traffic; and
- The speed differential between cyclists and motorists is high.

The design should guide cyclists and pedestrians in a manner that provides:

- A short distance across the ramp at close to a right angle;
- Improved sight distance in an area where traffic speeds are slower than further downstream; and
- A crossing in an area where drivers' attention is not entirely focused on merging with traffic.

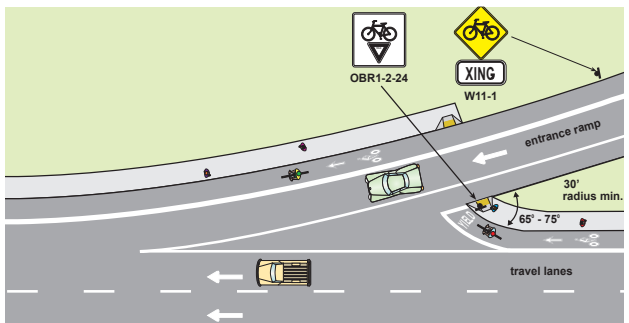

Figure 6-32: Bicyclist crossing at high speed entrance ramp

Exit Ramps

Exit ramps present difficulties for bicyclists and pedestrians because:

- Motor vehicles exit at fairly high speeds;
- The acute angle reduces visibility; and
- Exiting drivers who don't use their turn signal confuse pedestrians and cyclists seeking a gap in traffic.

The design should guide cyclists and pedestrians in a manner that provides:

- A short distance across the ramp, at close to a right angle;
- Improved sight distance in an area where traffic speeds are slower than further upstream; and
- A crossing in an area where the driver's attention is not distracted by other motor vehicles.

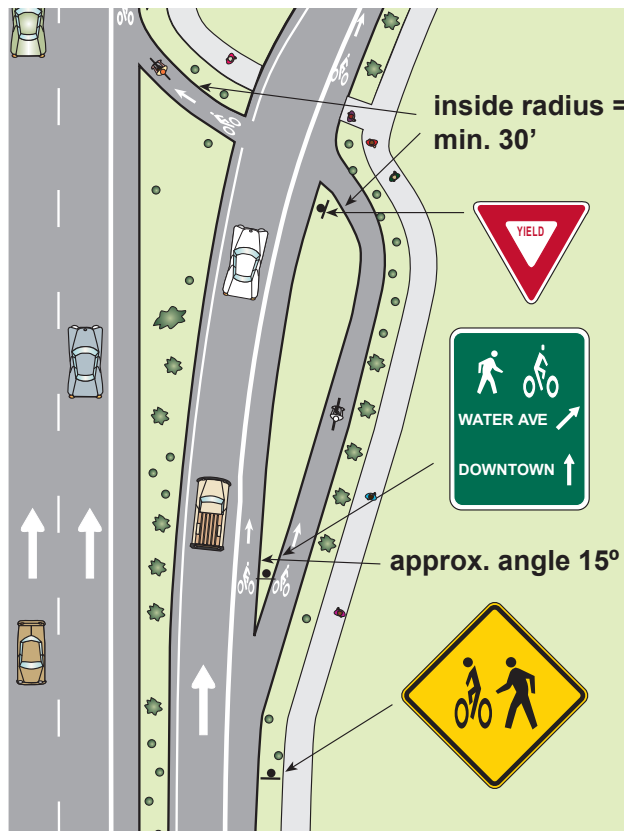

Figure 6-33: Pedestrian and bicyclist crossing at high speed exit ramp

Other Innovative Designs

These concepts are presented as information, to help ODOT, cities and counties to come up with new solutions to common intersection problems.

Bike Boxes

On streets with bike lanes and heavy bicycle use, there is often competition for space and time after a light has turned green at an intersection, as bicyclists, through and right-turning motorists try to proceed at the same time. The bike box reduces conflicts as cyclists can pull forward to the front of the queue when the light is red and motor vehicle traffic is stopped; they can then be the first to proceed when the light turns green. The bike box works best at intersections with no right turn on red and with high bicycle use, so drivers understand why they're being asked to hold back.

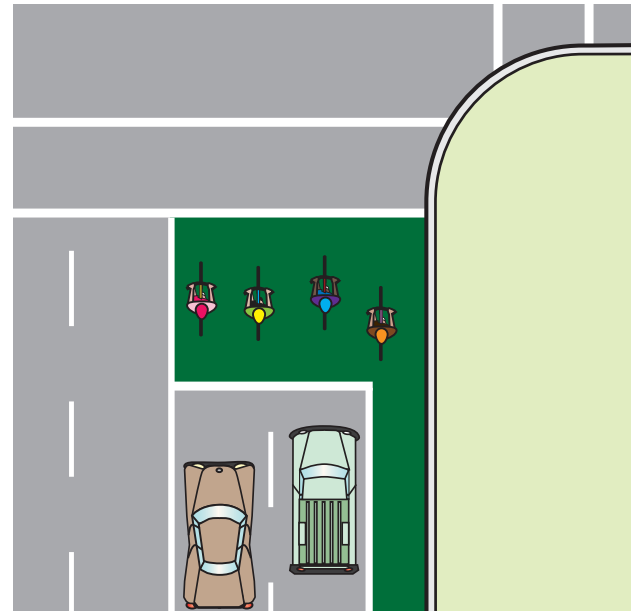

Figure 6-34: Bike box



Bike box (bicyclists may continue straight)

Raised Intersections

Raised intersections take the raised crosswalk concept one step further. Motorists see that the area is not designed for rapid through movement; it is an area where pedestrians are to be expected. The driver must be cautious in approaching the intersection and be ready to yield the right of way to pedestrians.

As with raised crosswalks, the incline of the beveled portion is a function of design speed and design vehicle.

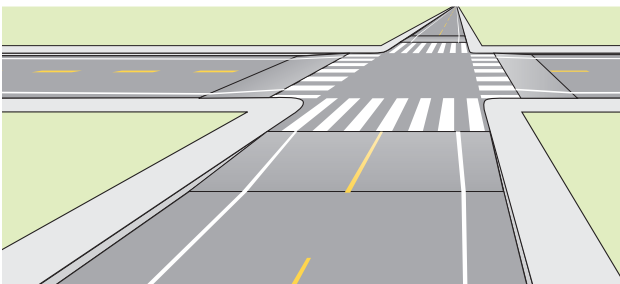

Figure 6-35: Raised intersection

Raised crosswalks and intersections have additional advantages:

- It is easier to meet certain ADA requirements, as the crosswalk is a natural extension of the sidewalk, with no change in grade, but they require detectable warnings to be detected by the visually-impaired; and
- Raised intersections can simplify drainage inlet placement, as all surface water will drain away from the intersection.

Note: *These treatments are more appropriate on low speed urban roads not high-speed thoroughfares, or on transit routes.*



Raised intersection keeps crossing level with sidewalk

CHAPTER 7: SHARED USE PATHS



Paths accommodate many users

Introduction

Originally called “bike paths,” then “multi-use paths,” shared-use paths are used by pedestrians, joggers, skaters, bicyclists and many others. Shared-use path planning and design must take into account the various skills and characteristics of these different users. Many inexperienced cyclists don’t want to ride in traffic and may not ride on streets until they gain experience and confidence. A separated path provides a learning ground for bicyclists and can attract cyclists who prefer a more aesthetic experience.

Well planned and designed paths can provide access and mobility to pedestrians and bicyclists in areas where the roads don’t serve their needs. They can have their own alignment along streams, canals, utility corridors, abandoned or active railroads, and greenways. Many serve as linear parks. Paths can serve both utilitarian and recreational cyclists.

The key components to successful paths include:

- Continuous separation from traffic, by locating paths along a river or a greenbelt such as a rail-to-trail conversion, with few street or driveway crossings; however, this must be balanced with:
- Frequent connections to land-uses, such as residential areas, shopping, schools and other destinations;
- Security: proximity to housing and businesses increases visibility (despite fears of some property owners, paths do not attract crime into adjacent neighborhoods); illumination helps provide a sense of security at night;
- Scenic qualities, offering an aesthetic experience that attracts cyclists and pedestrians;
- Well-designed street crossings, with measures such as signals or median refuge islands (paths directly adjacent to roadways are not recommended, as they tend to have many conflict points);

- Shorter trip lengths than the road network, with connections between dead-end streets or cul-de-sacs, or as short-cuts through open spaces;
- Good geometric design, by providing adequate width, grades, and curvature and avoiding problems such as poor drainage, blind corners and steep slopes;
- Good pavement design, including subgrade and base preparation, to ensure path longevity, good surface conditions and to reduce maintenance cost; and
- Proper maintenance: regular sweeping and repairs can prevent paths from falling into disrepair, with the subsequent increased liability and decreased use.



Paths are used by many non-motorized modes

Shared Use Paths vs. Cycle Tracks

Shared use paths share many commonalities with cycle tracks. However, shared use paths differ from cycle tracks in important ways.

Similarities:

- Separation from traffic;
- Used by bicyclists; and
- Driveway/alley/side street conflicts must be addressed.

Differences:

- Shared use paths are used by many modes: bikers, walkers, joggers, skaters, etc;

- Cycle tracks are for exclusive bicyclist use;
- Shared use paths are properly sited where driveways and side street conflicts are minimal;
- Shared use paths may or may not be adjacent to a roadway;
- Cycle tracks replace bike lanes;
- Shared use paths may compliment or supplement bike lanes;
- Shared use paths have two way, largely unregulated bicycle traffic; and
- Cycle tracks are most commonly one way, regulated bicycle traffic.

Important Considerations

To ensure success, the following concerns must be addressed at the planning, design, construction and maintenance phases of path projects:

Crossings

The number of at-grade crossings with streets or driveways should be limited; street crossings are one of the most important path design elements. At grade street crossings should be visible to drivers, with proper traffic control for path users and motorists. Where good quality street crossings cannot be obtained, crossings should be grade separated.

Access

Limiting crossings must be balanced with providing access. To serve users well, a path must have frequent and convenient access to the street network. Access points that are spaced too far apart will require users to travel out of direction to access or leave the path. The path should terminate where it is easily accessible to and from the street system, (e.g. at a controlled intersection or at the end of a dead-end street). Terminating a path midblock on a busy thoroughfare, or at a busy intersection, is generally not recommended; if there is no alternative, a well-designed connection and

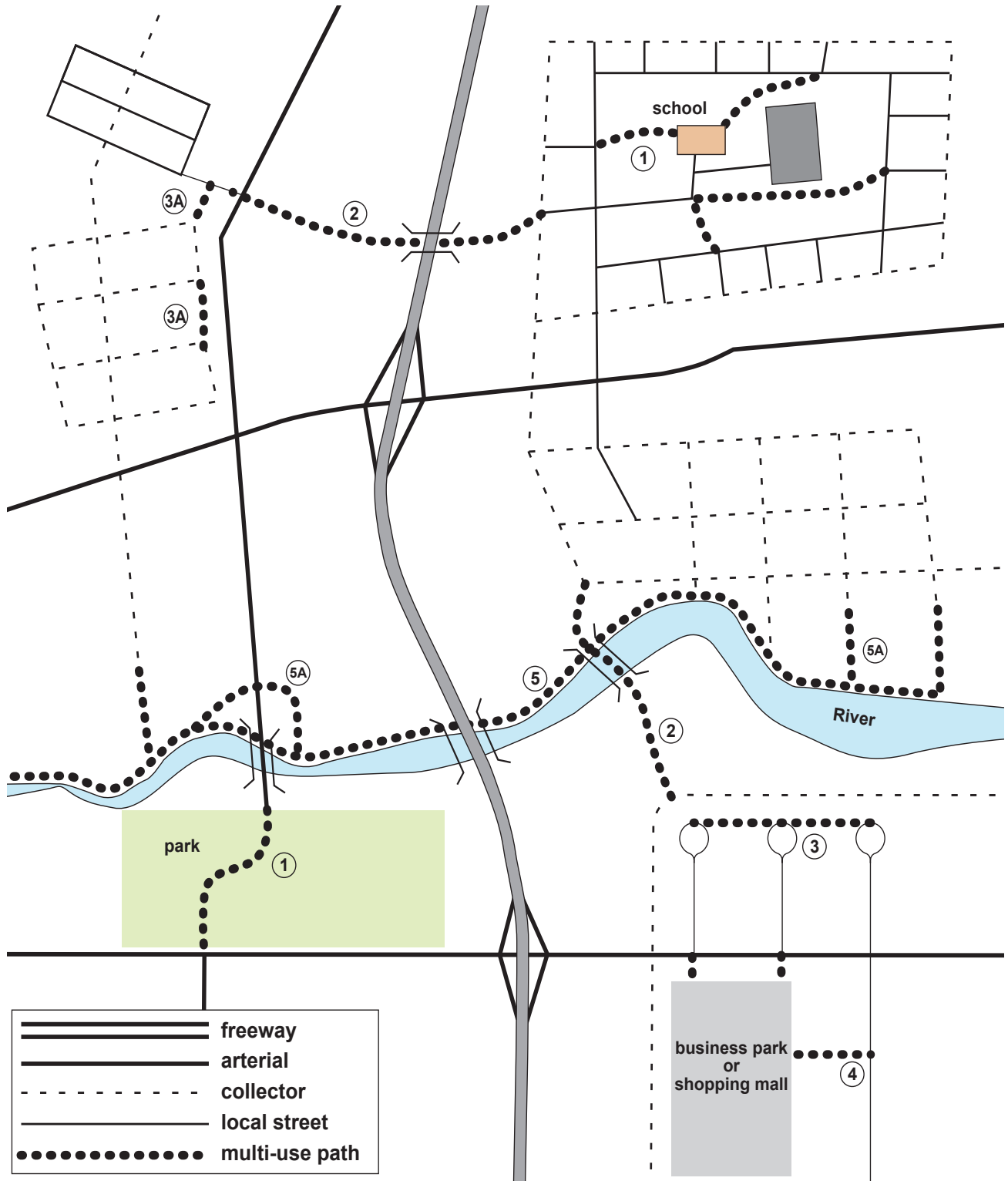

Figure 7-1: Shared-Use path siting considerations

crossing must be provided. Guide signs should be used to direct users to and from the path and to provide orientation and destination information on the path.

Security

Shared-use paths in secluded areas should ensure personal security. Illumination and clear sight distances improve visibility and comfort. Location markers, mileage posts and directional signing help users know where they are. Frequent accesses improve response time by emergency providers.

Maintenance

Shared-use paths require special trips for inspection, sweeping and repairs. They must be built to a standard high enough that allows heavy maintenance equipment to use the path without deterioration. Building to a high standard also decreases long-term maintenance needs and improves user comfort and safety.

On-street facilities

Many experienced bicyclists prefer to ride on the road rather than a path adjacent to roadways. This can be confusing to motorists, who may expect all cyclists to use the path. The presence of a path should not be used as a reason to not provide adequate shoulders or bike lanes on roads, where appropriate, or sidewalks for pedestrians in urban areas.

Standards

Paths should be built to a standard that accommodates all users, from commuters to recreationists, with minimal conflicts. Building a narrow path to save money can lead to problems if the path is popular. If usage is expected to be low, reconsider the need for a path. Pavement design is another important standard: even though paths do not get driven on by heavy motor vehicles, they do experience deterioration due to weather and aging. A path should last as many years as a residential street before needing maintenance or repaving.



Path connection to local street

Paths Next to Roadways

Concerns

Shared-use paths should not be placed next to roadways with many driveways and or street accesses. Half of the bicycle traffic will ride against the normal flow of motor vehicle traffic, with the following consequences for bicyclists:

- Research has shown that 95% of right turns are made without the driver ever looking right. Thus motorists crossing the path do not notice bicyclists coming from the direction opposite to prevailing traffic, especially if sight distance is poor.
- Bicyclists on the path are often required to stop or yield at cross-streets and driveways. Stopping often disrupts wheeled users' momentum; consequently, they end up not stopping, placing themselves in jeopardy when approaching a busy street crossing where yielding and/or stopping is required.
- Motor vehicles stopped on a cross-street or driveway may block the path.
- When the path ends, some bicyclists riding against traffic continue to travel on the wrong side of the street, as do bicyclists getting to a path. Wrong-way travel by bicyclists is a major cause of bicyclist-to-automobile crashes and should never be a design element, unless considerable care is taken to address the safety issues.

- Because of the proximity of motor vehicle traffic to opposing bicycle traffic, barriers may be necessary to separate the path from the roadway. Barrier design should take into consideration maintenance of the facility and use available right-of-way.

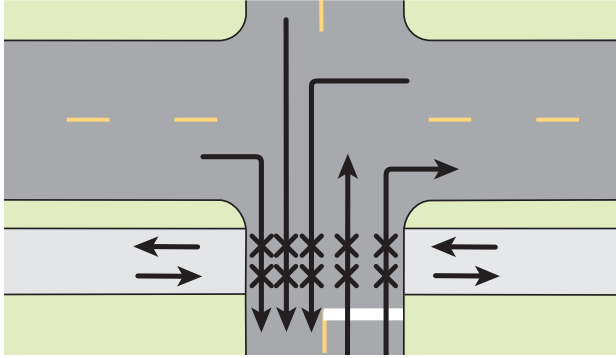

Figure 7-2: Intersection and driveway conflicts at path

Design Standards

ODOT has adopted the AASHTO Guide for the Development of Bicycle Facilities for path design standards. The AASHTO guide should be consulted for geometric design standards such as sight-distance, and horizontal and vertical curves. The following section is an explanation of these standards. Though shared-use paths are intended for many users, the bicycle is the appropriate design vehicle because of its higher travel speeds.

Most of the design standards discussed here are for paths intended for both transportation and recreation. For designing recreational trails in more rural settings, refer to “Designing Sidewalks and Trails for Access,” published by FHWA: Publication No. FHWA-HEP-99-006.

Standards should be met wherever possible, but there are circumstances where economics or physical constraints make it difficult to meet standards. A reasonable approach must be taken, so extraordinary sums are not spent on a short section of path; nor should the natural landscape be excessively disturbed.

Guidelines

Separated paths along roadways may be considered when:

Bicycle and pedestrian use is anticipated to be high;

The traffic conditions (high-speed, high-volumes) on the adjacent roadway are such that on-road bikeways and sidewalks may be undesirable;

The path can be kept separate from motor vehicle traffic, with few roadway or driveway crossings;

There are no reasonable alternatives for bikeways and sidewalks on nearby parallel streets;

There is a commitment to provide path continuity throughout the corridor;

The path can be terminated at each end onto streets with good bicycle and pedestrian accommodation, or onto another safe, well-designed path;

There is adequate access to local cross-streets and other facilities along the route;

Any needed grade-separation structures do not add substantial out-of-direction travel; and

The total cost of providing the path is proportionate to the need. This evaluation should consider the costs of:

Grading, paving, drainage, fences, retaining walls, sound walls, crossings, signs and other necessary design features;

Grade-separated structures needed to eliminate at-grade crossings; and

Additional maintenance, including the need for specialized maintenance equipment.

Note: In many cases, the best choice is to improve the roadway system to accommodate cyclists and pedestrians, which may require connecting up local streets or improving nearby, parallel streets.

Conversely, there are areas where high usage, or potentially high speeds dictate dimensions greater than standards for user safety and comfort.

Width & Clearances

Width

Ten feet is a common width for a two-way shared-use path and may be appropriate in a rural context; they should be 12 feet wide or more in areas with high mixed-use, in urban and suburban contexts. Faster-moving bicyclists require greater width than pedestrians; optimum width should be based on the relative use by these two modes. Twelve feet also allows for greater passing opportunities. High use by skaters may also require greater width.

The absolute minimum width for a two way path is 8 feet; to be used at pinch points only or where long-term usage is expected to be very low. Proper horizontal and vertical alignment is critical to ensure good sight distances.

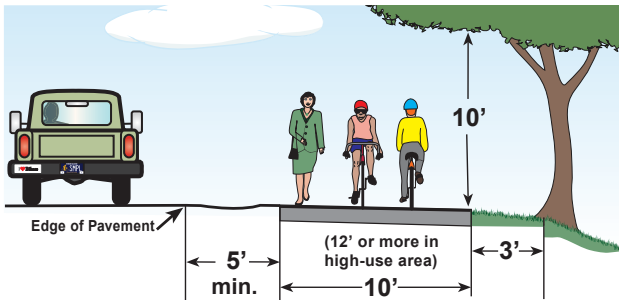

Figure 7-3: Suggested shared use path dimensions

Although one-way paths may be intended for one direction of bicycle travel, they will often be used as two-way facilities, especially by pedestrians. Caution must be used in selecting this type of facility. If needed, they should be 6 feet wide and designed and signed to ensure one-way operation by bicyclists. One-way paths are primarily used for short connections to a roadway.



Popular paths quickly become crowded

Paths with Heavy Use

A well-planned and designed path, connecting land uses conveniently, will attract many users and the path should be 12 feet or greater. A separate soft-surface jogger or equestrian path may be constructed with bark mulch adjacent to the paved path. A stable gravel shoulder is still required along the path edge to keep the surface from breaking up. Placing soft-surface jogger or equestrian path adjacent to the path also results in bark mulch encroaching onto the paved portion of the path.

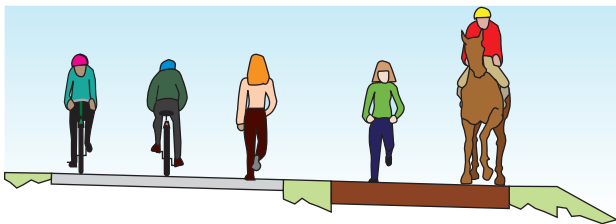

Figure 7-4: Paved path with separate soft surface trail



Gravel shoulders prevent raveling of path edges

With very high use by both pedestrians and bicyclists, the two modes can be separated with striping, to provide two one-way bike lanes next to a single walking area. For separation to work, adequate width for each mode must be provided. The minimum total width required is 16 feet: two 5-foot bike lanes and a 6-foot walking area. Eighteen or 20 feet are needed in areas of very high use or where users will want to stop to enjoy the view; the areas dedicated to walking and bicycling can vary based on their respective anticipated use. The pedestrian portion of the path should be closer to the vistas, such as next to a river, as pedestrians are more likely to linger, stop and admire views.

With exceptionally high use by both pedestrians and bicyclists, totally separate facilities should be considered: a path for cyclist and a path for pedestrians, with signing to indicate proper use.

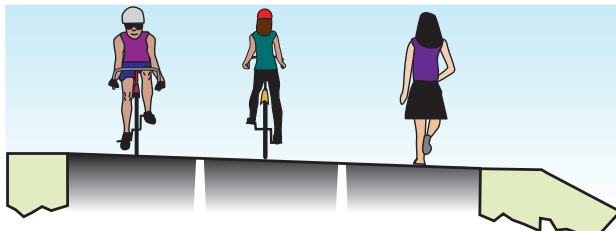

Figure 7-5: Wide path striped to separate modes



Path striped to separate users

Lateral Clearance

A 3 foot or greater (min. 2 feet) shy distance on both sides of a shared-use path is necessary for safe operation. This area should be graded level, flush to the path and free of obstructions to allow recovery by errant bicyclists. This applies to cut-sections, where falling debris can accumulate, stimulating weed growth, further restricting the available width.

Overhead Clearance

The standard clearance to overhead obstructions is 10 feet (min. 8 feet) where fixed objects or natural terrain prohibit the full 10 feet clearance.

Separation from roadway

Where a path is parallel and adjacent to a roadway, there should be a 5-foot or greater width separating the path from the edge of roadway, or a physical barrier of sufficient height should be installed.

Grades & Cross-Slope

AASHTO recommends a maximum grade of 5% for bicyclists, with steeper grades allowable for up to 500 feet, provided there is good horizontal alignment and sight distance; extra width is also recommended. Engineering judgment and analysis of controlling factors can help determine what distance is acceptable for steep grades.

On paths intended primarily for transportation, ADA requirements should be met: the grade of separated pathways should not exceed 5%, to accommodate wheelchair users. Based on AASHTO recommendations and ADA requirements, 5% should be considered the maximum grade allowable for shared-use paths.

For trails with primarily a recreational purpose in areas with steep terrain, these grades may be exceeded. Consult “Designing Sidewalks and Trails for Access” for guidance (Publication: FHWA-EP-01-027).

The standard cross-slope grade is 2%, to meet ADA requirements and to provide drainage. Sharp curves should be banked with the high side on the outside of the curve to help bicyclists maintain their balance.

Typical Pavement Sections

Shared-use paths should be designed with sufficient structural depth for the subgrade soil type and to support maintenance and emergency vehicles. A good rule of thumb is to use the typical pavement section recommended for local streets in a given environment. The pavement structures in Figure 7-6 are just examples; each path must be individually designed to meet the local geological and meteorological conditions.

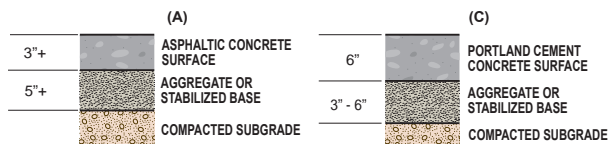

Figure 7-6: Sample pavement designs

The use of concrete surfacing for paths is best for long-term use. Concrete provides a smooth ride when placed with a slip-form paver. The surface must be cross-broomed. The crack-control joints should be saw-cut, not trowelled, to avoid a bumpy ride. Concrete paths cost more to build than asphalt paths, but long-term maintenance costs are lower, since concrete doesn't become brittle, cracked and rough with age, or deformed by roots and weeds, as does asphalt.

If the path is constructed over a very poor subgrade (wet and/or poor material), treatment of the subgrade with lime, cement or geotextile fabric (placed between the subgrade and the base rock) should be considered. Where paths are built in environmentally sensitive areas, the additional runoff must be accounted for. Pervious pavement materials should be considered in these circumstances, though care should be taken with pervious concrete – as

many pervious concrete mix designs result in a rice crispy like surface.

Drainage

Shared-use paths must be constructed with adequate drainage to avoid washouts and flooding, and to prevent silt from intruding onto the path due to standing water.

Vegetation

All vegetation, including roots, must be removed in the preparation of the subgrade. New growth should be controlled with a soil sterilant or lime treatment of the subgrade. Plants that can cause other problems should be controlled; for example, plants with thorns can puncture bicycle tires.

Paths built in wooded areas present special problems. The roots of shrubs and trees can pierce through the surface and cause it to heave and break apart. Preventive methods include removal of vegetation, realignment of the path away from trees, and placement of root barriers along the edge of the path. A 12 inches deep shield creates an effective barrier; greater depth is required for some trees such as cottonwoods.

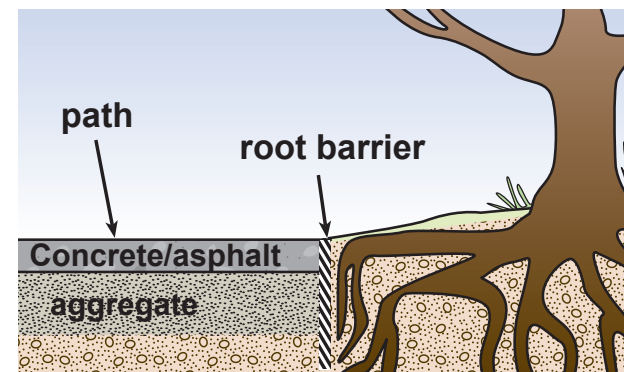

Figure 7-7: Barrier prevents roots from upheaving path

Railings, Fences & Barriers

Fences or railings along paths may be needed to prevent access to high-speed roadways, or to provide protection along steep side slopes and waterways. Fences should only be used where

they are needed for safety reasons. They should be placed as far away from the path as possible; minimum offset should be 2 feet. Many of these principles apply to cut-sections of paths where retaining walls are required: minimum 2 feet offset, with a rub-rail where feasible.

Forty-two inches height fence is recommended. Where concrete barriers are used, tubular railing may be added to achieve the required height. Openings in the railing must not exceed 6 inches in width. Where a cyclist's handlebar may come into contact with a fence or barrier, a smooth, 12 inches wide rub-rail should be installed at a height of 3 feet.

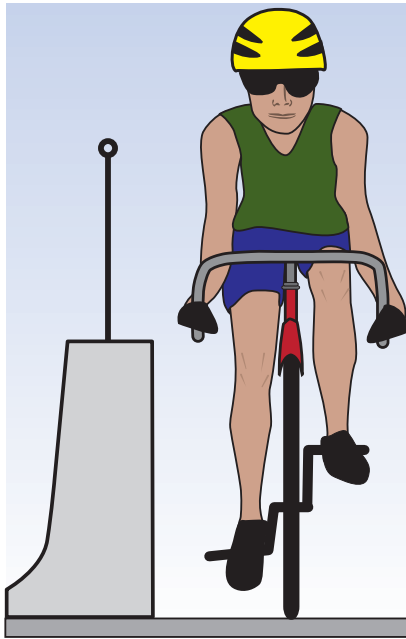

Figure 7-8: Railing added to concrete barrier

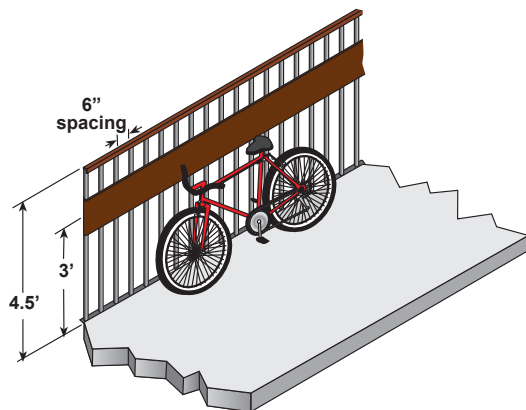

Figure 7-9: Rub rail added to railing

Double fencing should be avoided, (e.g. a fence at the right-of-way and a fence to keep pedestrians off freeways.) A high chain-link fence on each side of a path creates an undesirable cattle-chute effect, making users feel trapped.



Double fencing makes users feel trapped



Figure 7-10: High fencing at path edges creates cattle chute effect

The need to include a railing next to a path is dictated by a combination of factors, few of which can be isolated or quantified. When determining the need for a rail or barrier, the designer should look at the combined effects of:

- Clear zone (also called recovery zone): A 2-foot wide (1 foot min) level area should be provided at the outer edges of the paved area so users can recover their balance if they leave the pavement. Shrubbery planted at the edge of the slope (2 feet from the path edge) can help users shy away from the edge.

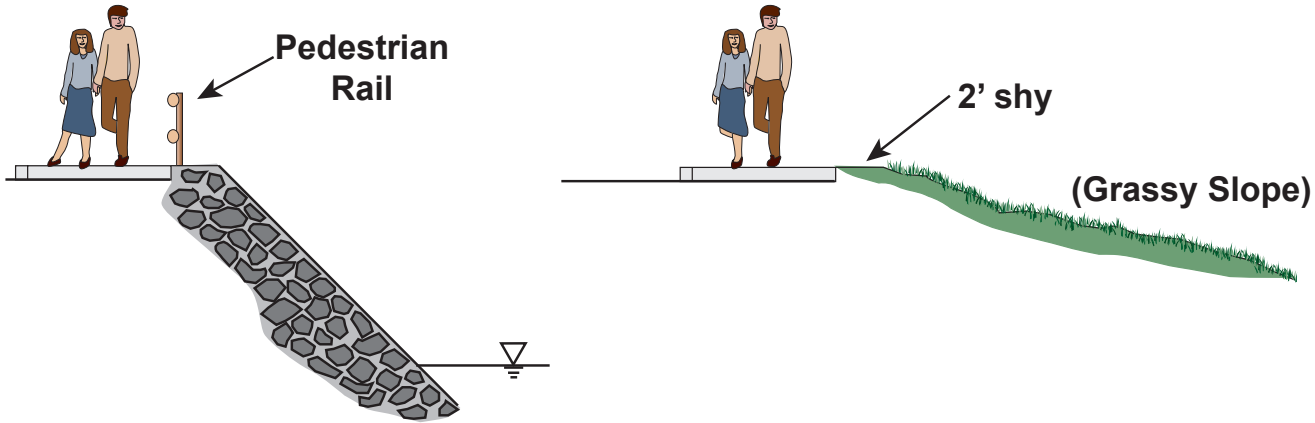

7-11: Railing needed on left, not needed on right

- Height: The need for railing increases with the height of the path above the adjacent roadway, waterway or other hazard, unless there are other mitigating factors. For most applications a rail height of 42 inches is adequate and preserves views. In locations where bicyclists should be protected from a severe hazard, a minimum railing height of 48 inches is recommended. The maximum rail height of 54 inches should be used only where bicyclists could vault over the railing – such as on a curved section at the bottom of a steep incline.
- Cut or fill cross-slope: 2:1 or flatter is generally considered adequate, unless side-slope material is potentially harmful. Cyclists are more comfortable with 3:1 or 4:1 slope. Maintenance staff prefer a flatter slope for mowing.
- Side-slope material: while a grassy berm or soft shrubbery would not harm a person falling, prickly vegetation, rip-rap, gabion baskets or other hard or jagged objects would not adequately protect a user from injury.
- Hazard below: a freeway, deep river or torrent is a greater potential hazard than a field of hay.
- Users: small children or seniors may need greater protection than other users.

These factors should be evaluated on a case-by-case basis, and a decision made based on engineering judgment. The best decision is to

flatten the slope to avoid the need for a barrier. Another option is to shift the path closer to the upslope, offering more shoulder at the down slope side.

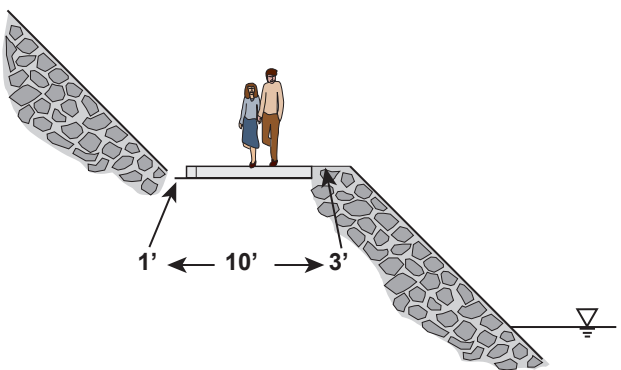

Figure 7-12: Offsetting path reduces need for railing



Gentle grassy slope eliminates the need for railing

Illumination

The need to illuminate paths depends on many factors:

- Location: is it isolated, or adjacent to a well-lit roadway?

- Purpose: is safety or security a concern?
- Security may require continuous illumination.
- Safety may require illumination only at street crossings and access points, especially where bollards and other objects are placed to prevent motor vehicle access.
- Light pollution concerns: many jurisdictions have adopted dark sky ordinances; low-level lighting aimed down at the path surface helps reduce light pollution, and illuminate the path surface.

Engineering judgment should be used to determine the need, quantity and type of path illumination. One solution to satisfy these often competing needs is to illuminate a path only in the evening, with a sign telling users when the lighting will be turned off.

Structures

The width of a shared-use path bridge is normally the same as the approach paved path. Where feasible, a 2-foot shy distance on both sides may be added for additional comfort. For example, a 14-foot wide structure for a 10-foot wide path.

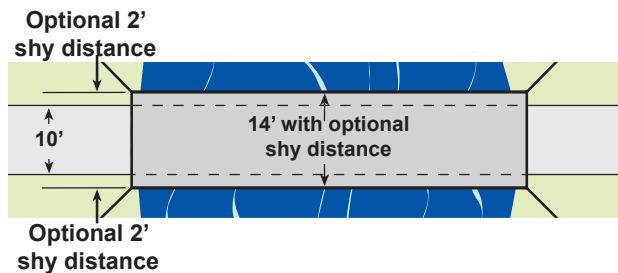

Figure 7-13: 14 feet wide bridge serves a 10 feet wide path

If the costs of a wider bridge are prohibitive, yet extra width is needed because it is anticipated that pedestrians will want to stop and linger to admire the view, viewpoints can be added by widening the bridge at scenic view points.

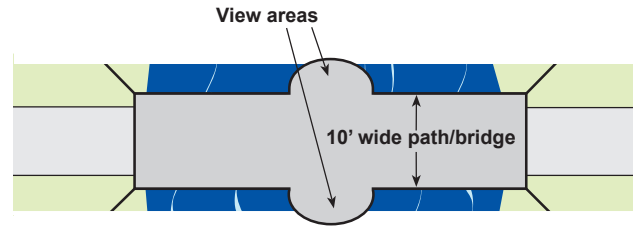

Figure 7-14: Bridge widened at view point



Pedestrians stop to admire the view in widened area without impeding thru traffic

Street crossings

Minor street crossings

In most cases, at-grade crossings of minor streets are acceptable. As traffic volumes on the cross-street increase, so does the need for special treatments, such as a median island or a signal.

The assignment of right of way must be consistent with accepted traffic engineering principles: if the number of anticipated path users is greater than the traffic on the cross-street, the latter should be required to yield or stop to path users. Only when the path crosses a street with higher traffic volumes should path users be required to yield to or stop for traffic on the cross-street. Path users should never be required to yield or stop to traffic at driveways.



Path crossing a minor street should have been given priority right of way

Requiring path users to stop or yield to traffic on minor streets and driveways creates a potential for conflicts and collisions, for the following reasons:

- Wheeled path users (cyclists, skaters etc.) who want to maintain their momentum, will quickly learn to ignore stop or yield signs at minor street or driveway intersections with little cross traffic. Then when a stop or yield sign is placed appropriately at a more important street crossing (with more traffic), cyclists, skaters, etc. often ignore it too, and proceed into traffic without stopping or yielding.
- This behavior carries over onto other streets, where cyclists have learned to ignore stop signs.
- Those who do stop at every driveway or minor street intersection cannot take advantage of the momentum naturally generated by cycling or skating.

Major street crossings

At-grade crossings of busy roads can introduce serious conflicts, and grade separation should be sought, as most path users expect continued separation from traffic.

When grade separation structures cannot be justified, signalization or other measures should be considered to reduce conflicts. Good sight distance must be provided so vehicle drivers can see approaching path users. Most of the

techniques described in Chapter 5 “Street Crossings” are applicable to path crossings (e.g. a traffic signal, a median island, advance stop lines on multi-lane roadways, etc.)

Where a path crosses a roadway at an intersection, improvements to the alignment should be made to increase the visibility of approaching path users. One method is to curve the path, so that it is not parallel to the adjacent roadway and the approach is a closer to a right angle. This improves visibility and forces cyclists to slow down.

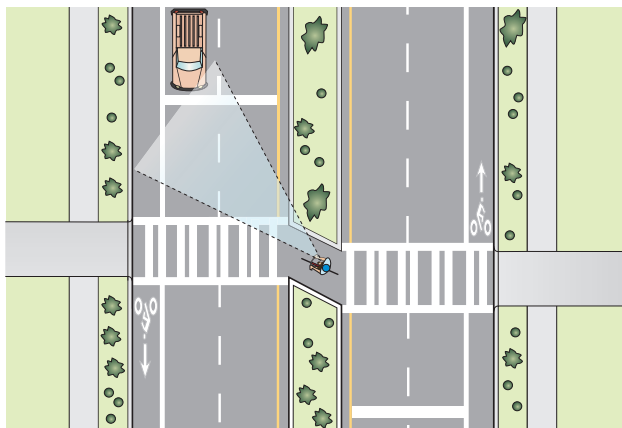

Figure 7-15: Midblock crossing with island and advance stop bar

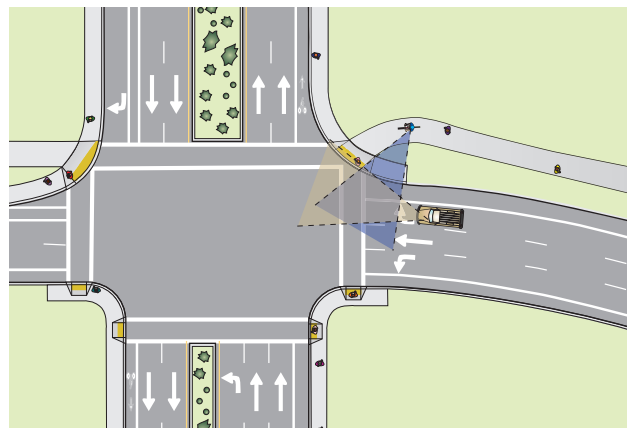

Figure 7-16: Path is curved to align with crosswalk

The greatest conflicts occur where paths cross freeway ramps. Motorists using these ramps are not expecting bicyclists and pedestrians at these locations.

At all path/roadway intersections, illumination should be provided so path users and vehicle drivers can see each other as they approach the conflict area. This is especially critical on paths that are otherwise unlit.

When traffic volumes are too high for path users to find acceptable gaps, even with a median island, signalization should be considered. The techniques in Chapter 5 can be used for path crossings.

Rails-to-trails crossings

Unlike trails built on a new alignment, rails-to-trail conversions follow the alignment of the old railbed. This can result in many midblock crossings, or crossings too close to intersections. Since the alignment cannot be changed, extra care and attention must be given to ensure drivers and path users are aware of the conflicts, and to provide the best-designed crossing possible.

Undercrossings vs. Overcrossings

When the decision has been made to separate a path from the roadway with a structure, the two choices are over and undercrossings. In some instances, natural terrain makes the choice obvious:

- If the roadway is lower than the path, an overcrossing is the obvious choice;
- If the roadway is higher than the path, the solution is an undercrossing.

When they are both at the same level, the decision is based on weighing a variety of factors. There are advantages and disadvantages to both overcrossings and undercrossings.

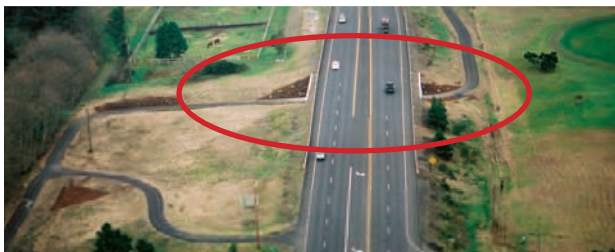

Path is fully separated with an undercrossing

Undercrossings

Advantages: They provide an opportunity to reduce approach grades, as the required 10 feet clearance is less than the clearance required for crossing over a roadway. They are often less expensive to build. Sometimes slightly elevating the roadway (3-4 feet) is enough to make an undercrossing attractive.

Disadvantages: They present security problems, due to reduced visibility. An open, well-lighted structure can cost as much as an overcrossing. They may require drainage if the sag point is lower than the water table.

Undercrossings should be 14 feet wide or more. The standard overhead clearance of under-crossings is 10 feet; an 8-foot minimum may be allowable with good horizontal and vertical clearance, so users approaching the structure can see through to the other end. Undercrossings should be visually open for users' personal security and comfort. Illumination is needed in areas of poor visibility, when the undercrossing is long and for nighttime comfort.

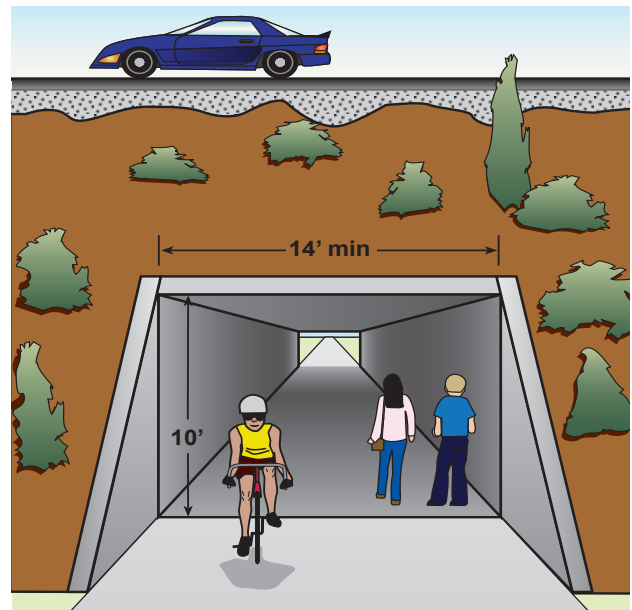

Figure 7-17: Undercrossing



Undercrossing with good sight lines

Overcrossings

Advantages: They are more open and present fewer security problems.

Disadvantages: They require longer approaches to achieve the required clearance

over roadways. The total rise can be 20 feet with an additional structural depth of 3 feet. At 5%, this requires a 400 foot approach ramp at each end, for a total of 800 feet. This can be lessened if the road is built in a cut section.

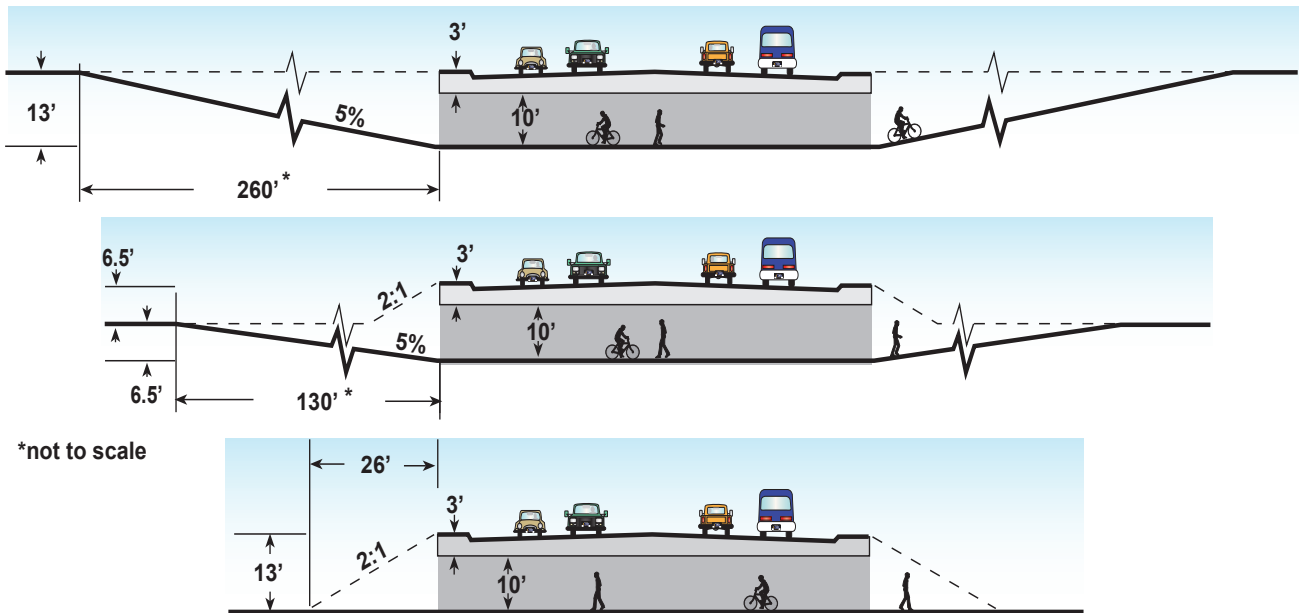

*not to scale

Figure 7-18: Path overcrossings, various configurations

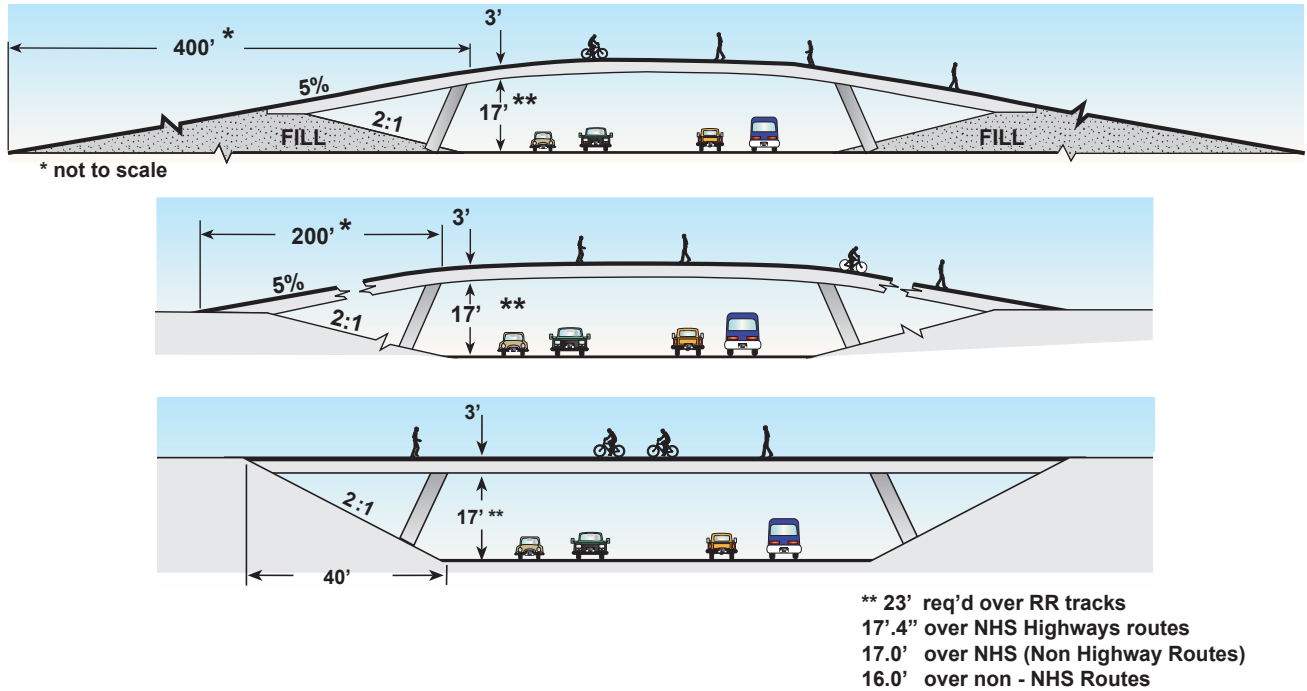

Figure 7-19: Path overcrossings, various configurations

Preventing Motor-Vehicle Access

Geometric Design

The most effective way to discourage motor vehicle access to paths is to make it physically difficult to do so. One method branches the path into two narrower one-way paths just before it reaches the roadway, making it difficult for a motor vehicle to gain access to the path.

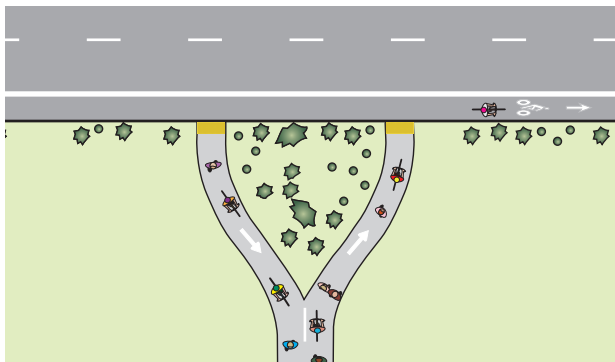

Figure 7-20: Path splits to prevent it appearing like a driveway

Another method is to create very tight curb returns to make it difficult for motorists to enter a path from the roadway.

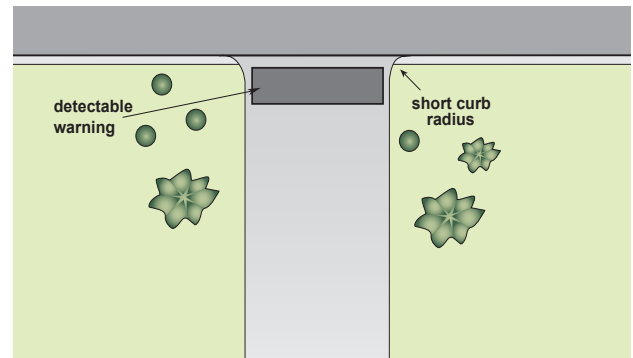

Figure 7-21: Tight curb radii prevent motor vehicle access

Bollards

Bollards may be used to limit vehicle traffic on paths. However, they are often hard to see, cyclists may not expect them and injuries result when cyclists hit them. Overuse of bollards is a serious hazard to bicyclists and may prevent path use by trailers, wheelchairs and other legitimate path users. In a group of riders, the riders in front block the visibility of those behind, setting up cyclists in the back of the pack for a crash.

Bollards should only be used when absolutely necessary. When used, they must be spaced wide enough (min. 5 feet) for easy passage by cyclists, bicycle trailers and adult tricycles as well as wheelchair users. A single bollard is preferred, as two may channelize bicyclists to the middle opening, with a potential for collisions. They should not be placed right at the intersection, but set back 20 feet or more, so users can concentrate on motor vehicle traffic conflicts rather than on avoiding the bollard. They should be painted with bright, light colors for visibility, illuminated and/or retro-reflectorized. A striped envelope around the bollard will direct path users away from the fixed object hazard. Flexible delineators, that collapse when struck by a bicyclist, should be considered.



Bollards are overused and can cause injury



Split path entry eliminates need for bollards

Offset Fencing

Placing railing or other barrier part way across a trail makes it possible for intended users to access the trail; maintenance vehicle operators are provided with keys to unlock the fences when they need access. The fences, like bollards, can be hazards to bicyclists and can restrict certain trail users from gaining access to the trail. They should be coated with retro-reflective material and well-lit.

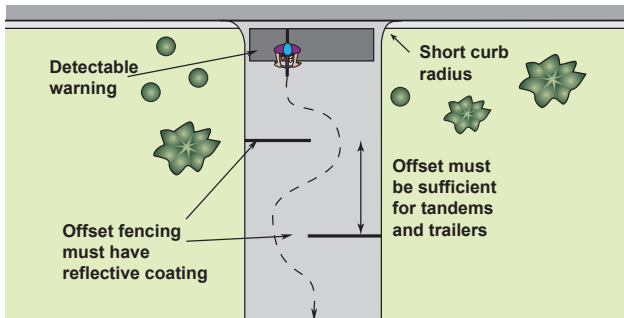

Figure 7-22: Offset gates prevent motor vehicle access



Offset fencing

Curb Ramps

Ramps for bicycle access to shared-use paths should be built so they match the road grade without a lip. The width of the ramp is the full width of the path when the approaching path is perpendicular to the curb and a minimum of 8 feet wide when the approaching path is parallel and adjacent to the curb. Greater widths may be needed on downhill grades.

Detectable warnings are required wherever a path intersects a public street; they should not be installed at driveways, nor where an on-road bike lane merges with an off-street path.

Stairways

Where a connection is needed to a destination or another path at a different elevation, a stairway can be used where the terrain is too steep for a path. A grooved trough should be provided so bicyclists can easily push their bicycles up or down.

Note: *Stairways are usually provided as a shortcut and do not meet all ADA requirements; destinations should also be accessible along a flatter route, even if it is longer and more circuitous. ADA should not be used as a reason to not provide stairs where beneficial and practicable.*



Metal channel (in yellow) provided for bicycle access

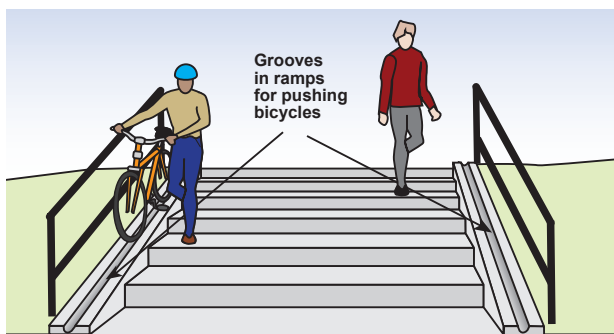

Figure 7-23: Stairway with channel for bicycle tires

Signs

Paths should be signed with appropriate regulatory, warning and destination signs.

Regulatory Signs

Regulatory signs inform users of traffic laws or regulations. They are placed at the point where the regulations apply. Common regulatory signs for bicyclists are signs R1-1 and R1-2 (Stop and Yield signs); they are reduced versions (18 inches x 18 inches) of standard motor vehicle signs, to be used where they are visible only to bicyclists (where a path crosses another path or where a path intersects a roadway at right angles).



Figure 7-24: Signs R1-1

Signs OBR1-1 and OBR1-2 should be used where the signs are visible to motor vehicle traffic (where a path is parallel and close to a roadway).

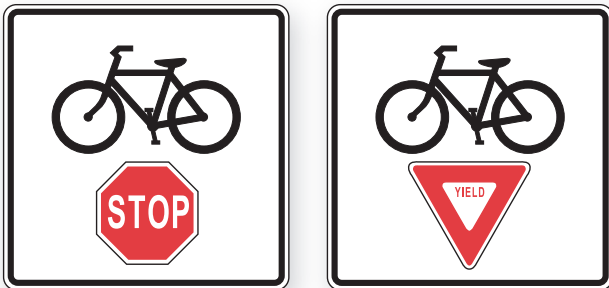

Figure 7-25: Signs OBR1-1 and OBR1-2

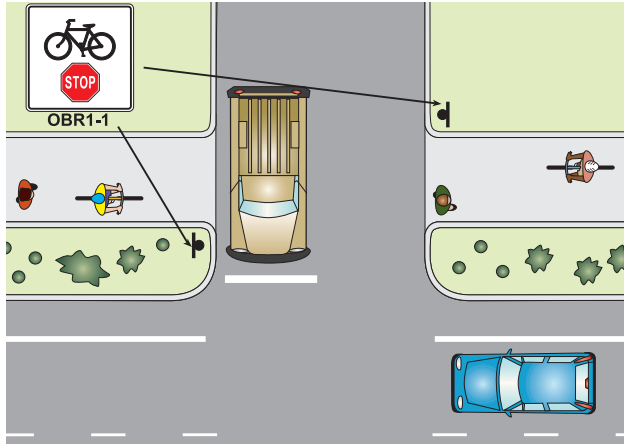

Figure 7-26: Appropriate use of sign OBR1-1 (or OBR1-2)

Sign R9-6 may be used at the beginning of shared-use paths and at important access points to warn cyclists of the presence of other users.

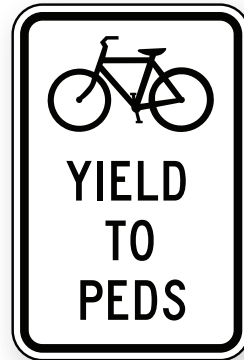

Figure 7-27: Sign R9-6

Signs R5-3 and OBR10-14 may be used at the beginning of a shared-use path if there are problems with motor vehicles using the path.



Figure 7-28: Signs R5-3 and OBR10-14

Where bicyclists using the path must cross a road at a signalized intersection (in a crosswalk) and proceed as pedestrians, sign R9-5 may be used.



Figure 7-29: Sign R9-5

Warning Signs

Warning signs are used to inform path users of potentially hazardous conditions. They should be used in advance of the condition. Most are reduced versions (18 inches X 18 inches) of standard highway warning signs.

Curves:

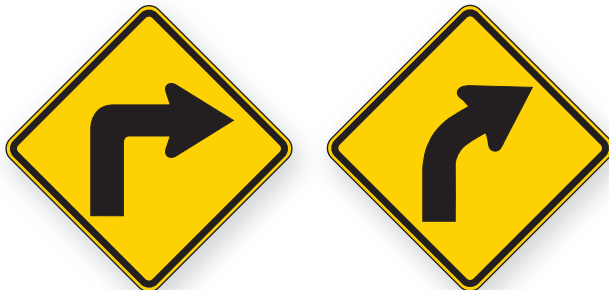

Figure 7-30: Signs W1-1 and W1-2 (18"x18")

Intersections:

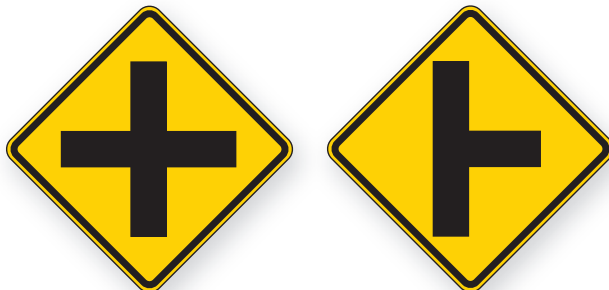

Figure 7-31: Signs W2-1 and W2-2 (18"x18")

Hill:



Figure 7-32: Sign W7-5

Height and Width Constraints:

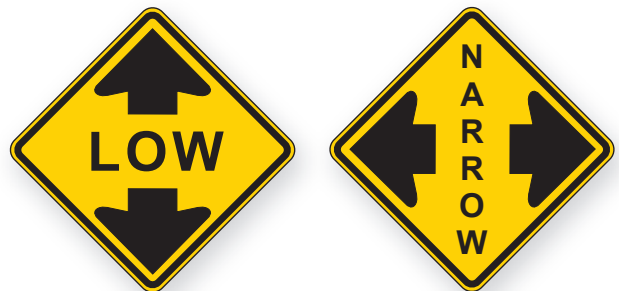

Figure 7-33: Signs OBW12-2 and OBW12-3 (18"x18")

Railroad, STOP Ahead, etc:



Figure 7-34: Signs W10-1 and W3-1 (18"x18")

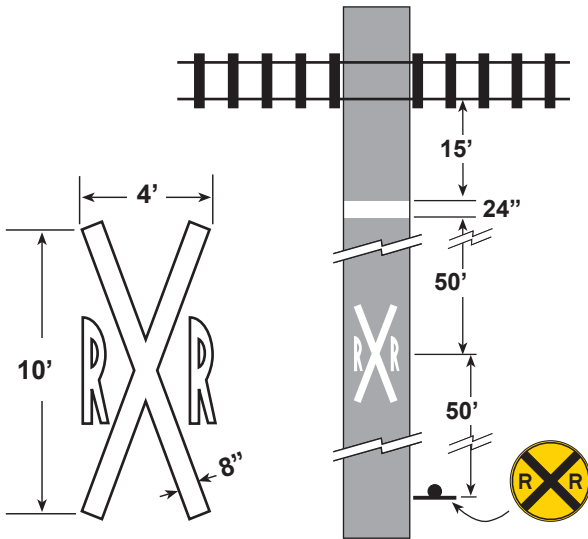

Figure 7-35: Railroad crossing ahead markings

Path Crossing Roadway

Sign W11-15 with “XING” rider should be used only where a shared-use path crosses a roadway at an uncontrolled location. This sign is not for use where bike lanes cross streets at controlled intersections.

Directional, Destination & Street Signs

Where a path crosses a roadway or branches off into another path, directional and destination signs should be provided. It is also helpful to have street name signs at street crossings and access points. Signs directing users to the path are also helpful.



Figure 7-37: Directional and street signs



Figure 7-36: Sign W11-15 with rider W11-15P

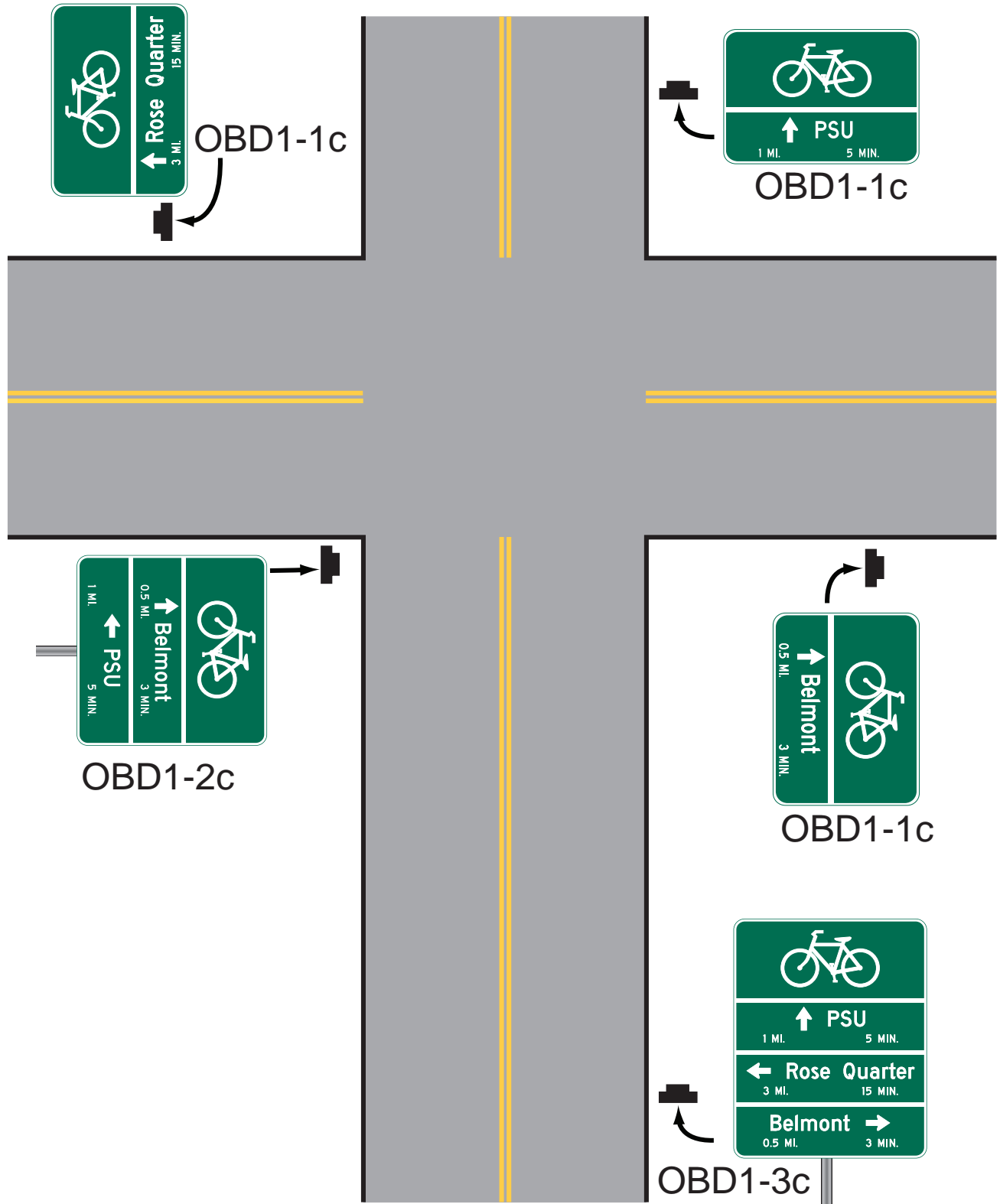

Figure 7-38: Bicycle Route Sign Examples

End of Path

Where bicyclists continue riding on the roadway at the end of a path, the following sign should be used to direct cyclists to the right side of the road to minimize wrong-way riding. Guide signs should be used to direct bicyclists to their destinations.

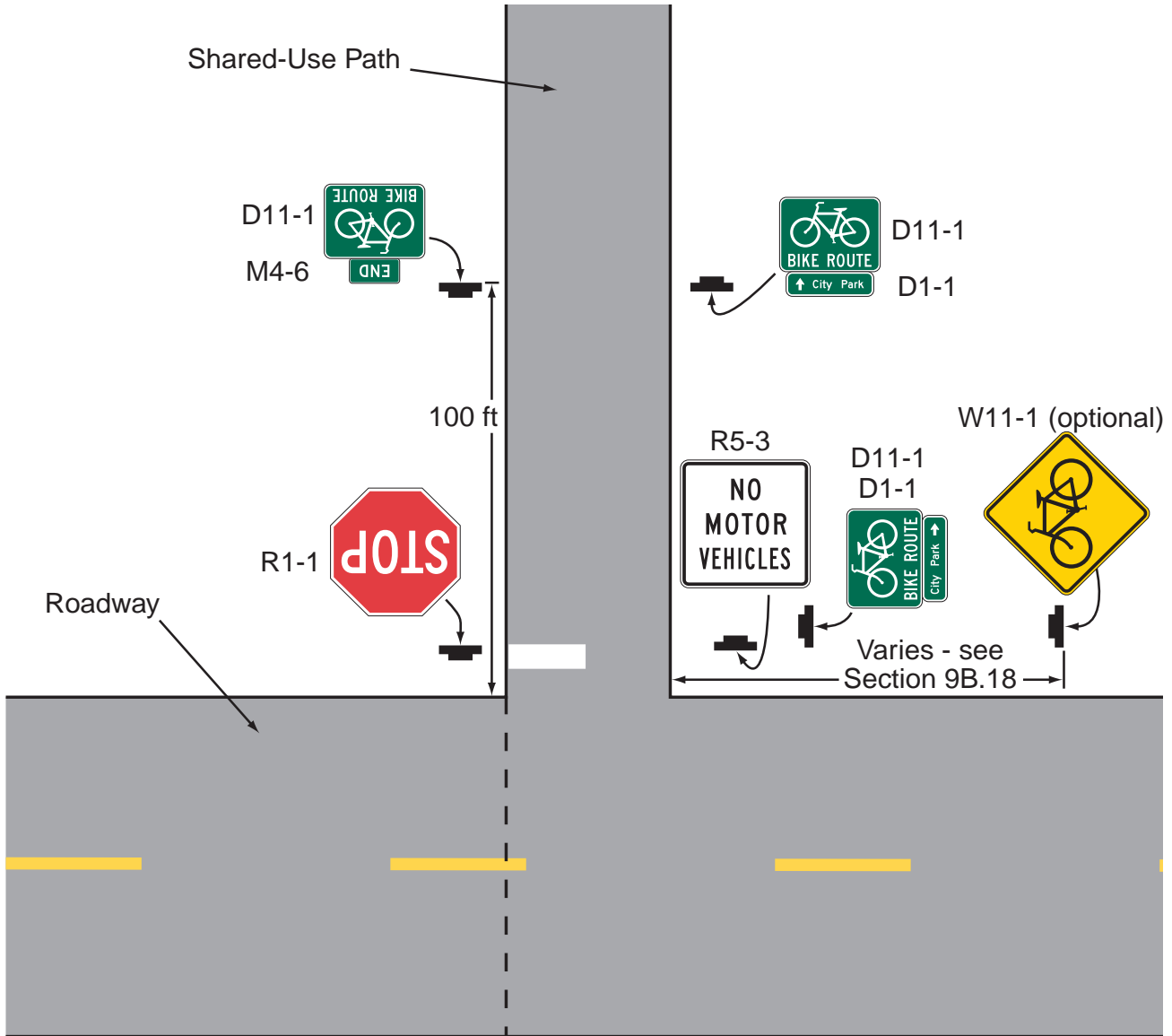

Figure 7-39: Beginning and end of path signing

Placement of Signs

Signs should have 3 feet of lateral clearance from the edge of the path (min 2 feet). Because of cyclists' and pedestrians' lower line of sight, the bottom of signs should be about 5 feet above the path. If a secondary sign is mounted below another sign, it should be a minimum of 4 feet above the path. Signs placed over a path should have a minimum vertical clearance of 8 feet.

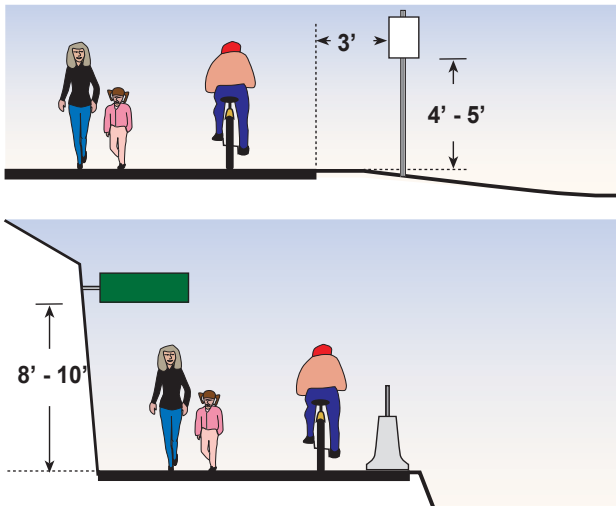

Figure 7-40: Sign mounting clearances

Striping

A centerline stripe is generally not recommended for shared-use paths. Users like to walk or ride side-by-side; a centerline stripe makes them feel confined to one side only, which is rarely possible on a standard 10-foot path. A solid centerline stripe may be used through curves and areas of poor sight distance; the approach to this area may be striped with dashes.

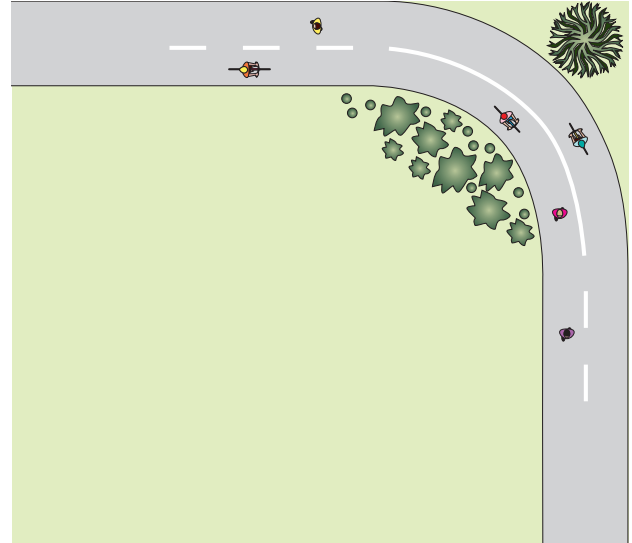

Figure 7-41: Skip stripe followed by solid stripe in a curve

