

GypWall QUIET

Twin frame high performance acoustic wall system

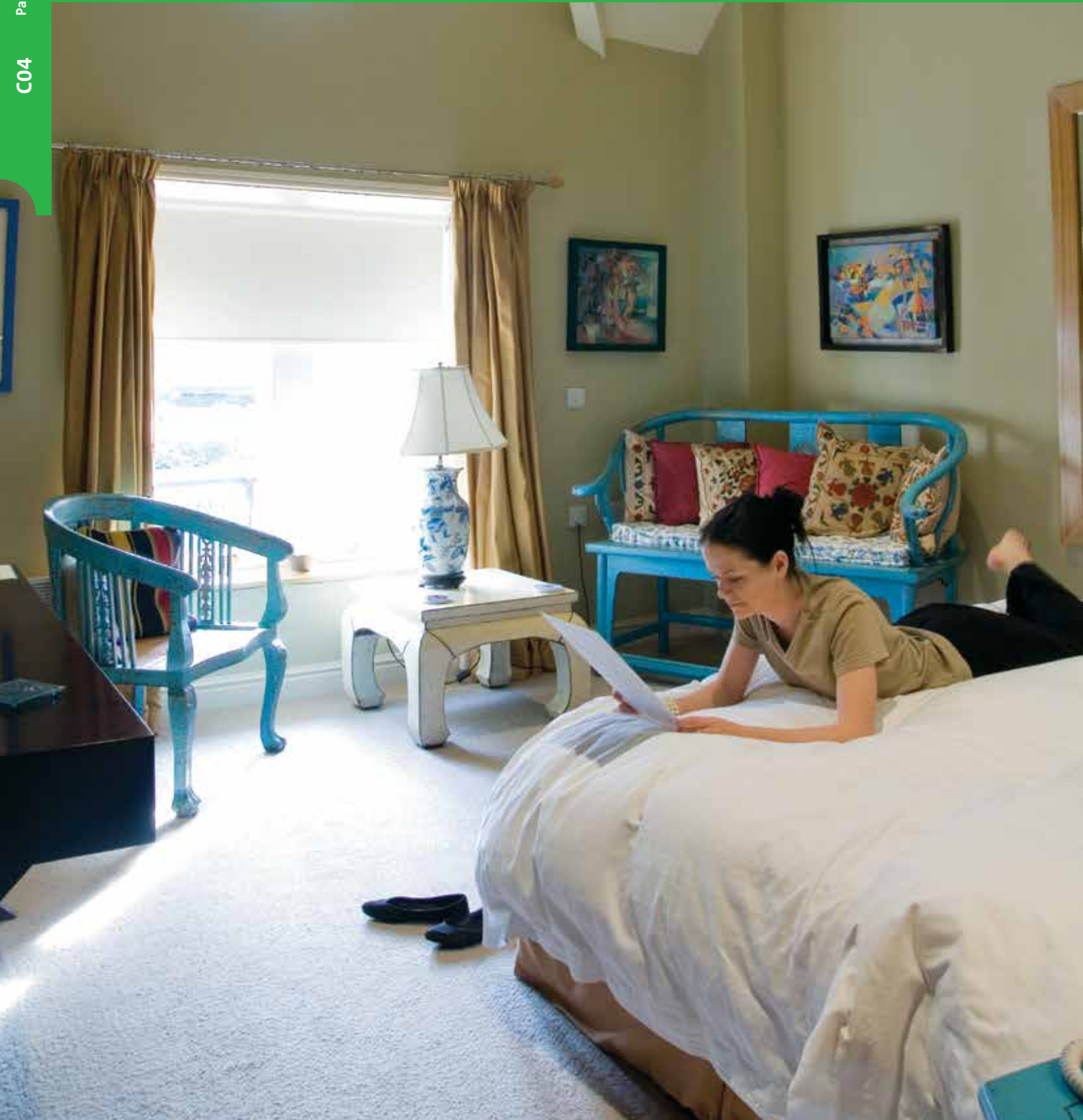

All our systems are covered by SpecSure® when using genuine Gyproc and Isover products



GypWall QUIET

GypWall QUIET is a lightweight, non-loadbearing, twin framed acoustic separating wall, often used in developments such as apartments, hotels, hospitals and schools where a high level of acoustic performance is required to either meet or exceed Building Regulations.

Key benefits

- GypWall QUIET can provide up to an estimated 90 minutes fire protection to structural steel enclosed within its cavity, whilst maintaining the room-to-room acoustic performance
- Twin-frame design allows services and structural steel to easily be accommodated within the partition
- Reduced sound transmission is achieved by a high degree of isolation between the two frameworks and the use of high performance Gyproc plasterboard linings
- Additional acoustic performance can be achieved with the application of Gyproc Finish Plasters

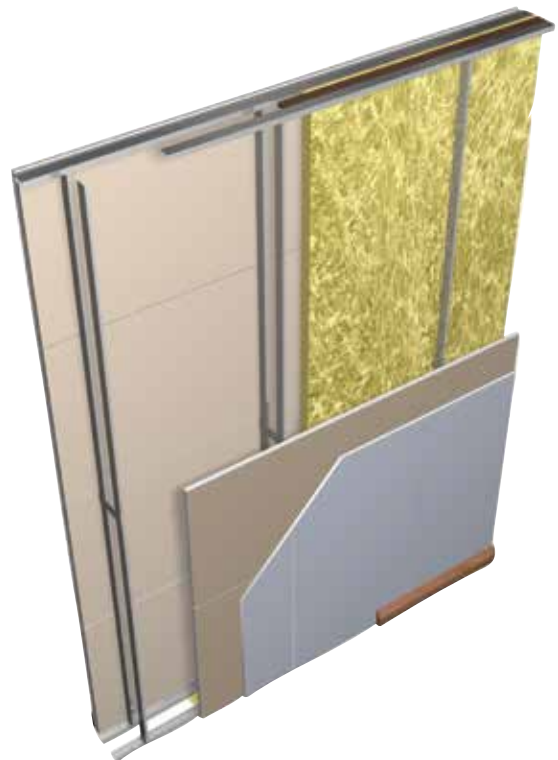
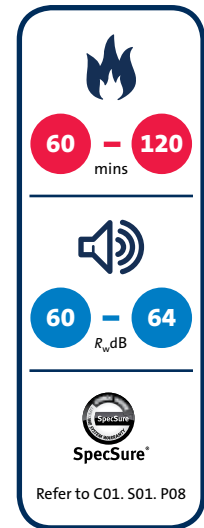

You may also be interested in...

GypWall QUIET IWL

Looking for an increase in acoustic performance? For example, if designing for a prestigious development or to achieve credits towards a BREEAM framework.

GypWall QUIET IWL provides greater levels of acoustic insulation, through the use of a totally isolated twin stud frameworks.

► Refer to C04. S08. P231 – **GypWall QUIET IWL**

GypWall QUIET performance

48mm Gypframe 'C' Studs with cross braces

For details of when to specify fire resistance using EN
 ► Refer to C02. S01. P18



Table 1a — Solutions to satisfy the requirements of BS EN 1364-1: 1999

①

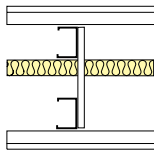

Two Gypframe 48 S 50 'C' Stud frameworks braced at max. 1200mm centres. Studs at 600mm centres. Isover Acoustic Roll in the cavity (cavity width 137mm). Linings and insulation as in table.

②

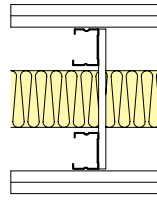

Two Gypframe 48 S 50 'C' Stud frameworks braced at max. 1200mm centres. Studs at 600mm centres. Isover Acoustic Slab in the cavity (cavity width 190mm). Linings and insulation as in table.

③

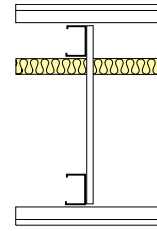

Two Gypframe 48 S 50 'C' Stud frameworks braced at max. 1200mm centres. Studs at 600mm centres. Isover Acoustic Roll in the cavity (cavity width 237mm). Linings and insulation as in table.

Detail	Partition thickness mm	Board type mm	Lining thickness mm	Max. partition height ¹ mm	Insulation thickness mm	Sound insulation $R_w + C_{tr}$ dB		Duty rating	Approx. weight kg/m ²	System reference	
						Any ² finish	Skim ³ only			Any ² finish	Skim ³ only
60 minutes fire resistance (EN)											
①	200	Gyproc Plank + Gyproc SoundBloc	1 x 19 + 1 x 12.5	6200	25	61 (47)	-	Severe	55	A216001	-
①	200	Gyproc SoundBloc	2 x 15	6200	50	62 (56) ⁴	63 (56) ⁴	Severe	55	A216009	A216009S
②	250	Gyproc SoundBloc	2 x 15	6200	75	63 (57) ⁴	64 (57) ⁴	Severe	55	A216011	A216011S
③	300	Gyproc Plank + Gyproc SoundBloc	1 x 19 + 1 x 12.5	6200	25	62 (52) ⁴	-	Severe	55	A216002	-
③	300	Gyproc SoundBloc	2 x 15	6200	25	63 (57) ⁴	64 (57) ⁴	Severe	55	A216008	A216008S
90 minutes fire resistance (EN)											
①	200	Gyproc Plank + Gyproc SoundBloc	1 x 19 + 1 x 12.5	5000	25	61 (47)	-	Severe	55	A216001	-
②	250	Gyproc SoundBloc	2 x 15	5000	75	63 (57) ⁴	64 (57) ⁴	Severe	55	A216011	A216011S
③	300	Gyproc Plank + Gyproc SoundBloc	1 x 19 + 1 x 12.5	5000	25	62 (52) ⁴	-	Severe	55	A216002	-
③	300	Gyproc SoundBloc	2 x 15	5000	100	64 (58) ⁴	-	Severe	55	A216012	-
120 minutes fire resistance (EN)											
①	200	Gyproc FireLine	2 x 15	7500	50	60 (53) ⁴	61 (53) ⁴	Severe	52	A216010	A216010S

► For further assistance in choosing the right solution for your project, try our System Selector; an online tool that enables quick and easy filtering by performance criteria. It provides system specific information downloads including BIM (Revit) objects. Go to gyproc.ie

¹ The maximum heights quoted are limited by the fire state field of application or by limiting deflection of L/240 at 200 Pa, whichever is the more onerous.

² Sound insulation performance for partitions finished using jointing or plaster skim.

³ Sound insulation performance for partitions finished with a 2mm skim finish of Gyproc Finish Plasters.

⁴ These Gyproc Approved Systems are designed to achieve minimum $D_{nT,w} + C_{tr}$ 45dB, subject to Pre-Completion Testing (Refer to Partitions introduction C04. S01. P109 – table 1).

NB For heights above 4200mm Gypframe Deep Flange Floor & Ceiling Channel should be used at base and at head (subject to deflection criteria).

NB The fire resistance and sound insulation performances are for imperforate partitions, walls and ceilings incorporating boards with all joints taped and filled, or skimmed according to Gyproc's recommendations. The quoted performances are achieved only if Gyproc and Isover components are used throughout, and the Company's fixing recommendations are strictly observed. Any variation in the specifications should be checked with Gyproc.

GypWall QUIET performance (continued)

48mm Gypframe 'C' Studs with cross braces

For details of when to specify fire resistance using BS
 ▶ Refer to C02. S01. P18



Table 1b — Solutions to satisfy requirements of BS 476: Part 22: 1987

①	②	③
Two Gypframe 48 S 50 'C' Stud frameworks braced at max. 1200mm centres. Studs at 600mm centres. Isover Acoustic Roll in the cavity (cavity width 137mm). Linings and insulation as in table.	Two Gypframe 48 S 50 'C' Stud frameworks braced at max. 1200mm centres. Studs at 600mm centres. Isover Acoustic Slab in the cavity (cavity width 190mm). Linings and insulation as in table.	Two Gypframe 48 S 50 'C' Stud frameworks braced at max. 1200mm centres. Studs at 600mm centres. Isover Acoustic Roll in the cavity (cavity width 237mm). Linings and insulation as in table.

Detail	Partition thickness mm	Board type mm	Lining thickness mm	Max. partition height ² mm	Insulation thickness mm	Sound insulation $R_w (R_w + C_{tr})$ dB		Duty rating	Approx. weight kg/m ²	System reference	
						Any ³ finish	Skim ⁴ only			Any ³ finish	Skim ⁴ only

90 minutes fire resistance BS											
①	200	Gyproc Plank + Gyproc SoundBloc	1 x 19 + 1 x 12.5	6200	25	61 (47)	-	Severe	55	A216001	-
①	200	Gyproc SoundBloc ¹	2 x 15	7500	50	62 (56) ⁵	63 (56) ⁵	Severe	55	A216009	A216009S
②	250	Gyproc SoundBloc ¹	2 x 15	7500	75	63 (57) ⁵	64 (57) ⁵	Severe	55	A216011	A216011S
③	300	Gyproc Plank + Gyproc SoundBloc	1 x 19 + 1 x 12.5	6200	25	62 (52) ⁵	-	Severe	55	A216002	-
③	300	Gyproc SoundBloc ¹	2 x 15	7500	25	63 (57) ⁵	64 (57) ⁵	Severe	55	A216008	A216008S
120 minutes fire resistance BS											
①	200	Gyproc FireLine	2 x 15	7500	50	60 (53) ⁵	61 (53) ⁵	Severe	52	A216010	A216010S

▶ For further assistance in choosing the right solution for your project, try our System Selector; an online tool that enables quick and easy filtering by performance criteria. It provides system specific information downloads including BIM (Revit) objects. Go to gyproc.ie

¹ To achieve an estimated 120 minutes fire resistance, substitute 2 x 15mm Gyproc SoundBloc for 2 x 15mm Gyproc DuraLine.

² Based on limiting deflection of L/240 at 200 Pa.

³ Sound insulation performance for partitions finished using jointing or plaster skim.

⁴ Sound insulation performance for partitions finished with a 2mm skim finish of Gyproc Finish Plasters.

⁵ These Gyproc Approved Systems are designed to achieve minimum $D_{n,TW} + C_{tr}$ 45dB, subject to Pre-Completion Testing (Refer to Partitions introduction C04. S01. P109 – table 1).

NB For heights above 4200mm Gypframe Deep Flange Floor & Ceiling Channel should be used at base and at head (subject to deflection criteria).

NB The fire resistance and sound insulation performances are for imperforate partitions, walls and ceilings incorporating boards with all joints taped and filled, or skimmed according to Gyproc's recommendations. The quoted performances are achieved only if Gyproc and Isover components are used throughout, and the Company's fixing recommendations are strictly observed. Any variation in the specifications should be checked with Gyproc.

For details of when to specify fire resistance using EN / BS
 ▶ Refer to C02. S01. P18



Table 2 — Solutions to satisfy requirements of ENV 13381-2: 2002 and BS 476: Part 21: 1987¹

Board type ²	Lining thickness mm	Fire resistance min	Section factor ³ A/V (Hp/A) m ⁻¹
Gyproc SoundBloc	2 x 12.5	30	Up to 300
Gyproc SoundBloc	2 x 15	60	Up to 300
Gyproc Plank + Gyproc SoundBloc	1 x 19 + 1 x 12.5	60	Up to 300
Gyproc FireLine or Gyproc DuraLine	2 x 15	90	Up to 300

¹ Estimated fire protection to structural steelwork within this partition cavity.

² For improved durability and impact resistance, the outer layer of Gyproc FireLine or Gyproc SoundBloc can be replaced with a layer of 15mm Gyproc DuraLine.

³ Based on four-sided exposure, with no vertical joints aligning with the column, and boards not fixed to the column to maintain air space (10mm for BS or 50mm for EN).

GypWall QUIET design

Building design

GypWall QUIET comprises twin row Gypframe 'C' Studs at 600mm centres within twin row Gypframe Floor & Ceiling Channels. For heights up to 2400mm each pair of studs must be cross braced at mid-height. Where multiple braces are required the braces must be located at 1200mm vertical centres staggered by 600mm.

Planning — key factors

The position of services and heavy fixtures should be pre-determined and their installation planned into the frame erection stage. All penetrations will need to be adequately stopped for fire and acoustics.

Fixing floor and ceiling channels

Gypframe Floor & Ceiling Channels must be securely fixed with a row of fixings at 600mm maximum centres. If the floor is uneven, a 38mm thick timber sole plate equal to the width of the channel should be used.

If the concrete or screeded floor is new, consideration should be given to the installation of a damp-proof membrane between the floor surface and the channel or sole plate.

Splicing

To extend studs, overlap by 600mm (minimum). Fix together using Gyproc Wafer Head Drywall Screws or steel pop rivets (two to each flange).

▶ Refer to Partitions introduction C04. S01. P110 – construction detail 1.

Partition to structural steelwork junctions

When designing the layout of rooms requiring separation by sound insulating walls abutting structural steelwork, consideration should be given to the potential loss of sound insulation performance through the steelwork.

▶ Refer to C02. S01. P21 – Building acoustics.

Door openings

The designer should consider the thickness tolerances of the partition types in relation to the proposed door frame detail. To satisfy BS 5234 requirements for Heavy and Severe Duty partitions, door framing should be specified as shown in C04. S01. P119 – construction detail 26. The door manufacturer should also be consulted in relation to the door detail.

If a plastered finish is specified, the thickness of the door or glazing frame must allow for the thickness of the plaster finish.

Cavity fire barriers

Where required to maintain fire performance, suitable fire stopping (by others) should be installed full filled within the partition cavity to form a suitable closure.

Deflection heads

Partition head deflection designs may be necessary to accommodate deflections in the supporting floor. Deflection heads may also be required to the underside of roof structures subjected to positive and negative pressures.

Special detailing to minimise the loss of acoustic performance:

▶ Refer to C02. S01. P21 – Building acoustics.

For deflection head design refer to construction detail 2 within this section.

Services

Penetrations

Penetrations of fire-resistant or sound-insulating constructions for services need careful consideration to ensure that the performance of the element is not downgraded. Consideration also needs to be given to the services themselves so they do not act as the mechanism of fire spread or sound transmission.

▶ Refer to C02. S01. P41 – Service installations.

Electrical

The installation of electrical services should be carried out in accordance with BS 7671. The cut-outs in the studs can be used for routing electrical and other small services (Partitions introduction C04. S01. P110 – construction detail 2). Switch boxes and socket outlets can be supported from Gypframe 99 FC 50 Fixing Channel fixed horizontally between studs, or a high performance socket box detail used where higher acoustic performance is required.

Independent support

When designing for the installation of services such as fire dampers and associated ductwork through a GypWall partition, consideration should be given to the size and weight of the damper - this will determine whether it can be supported directly from the partition or needs to be independently supported from the structure.

▶ Refer to Partitions introduction C04. S01. P122 – construction details 29-31.

Fixtures

Lightweight fixtures can be made directly to the partitions. Medium weight fixtures can be made to Gypframe 99 FC 50 Fixing Channel. Heavyweight fixtures (to BS 5234), such as wash basins and wall cupboards, can be fixed using plywood secured with Gypframe Service Support Plates.

▶ Refer to C02. S01. P41 – Service installations.

Board finishing

▶ Refer to C08. S01. P517 – Finishes.

Tiling

Tiles can be applied to the surface of lightweight partition systems.

▶ Refer to C08. S04. P531 – Tiling



SpecSure®

All our systems are covered by SpecSure® when using genuine Gyproc and Isover products.

GypWall QUIET construction details

1

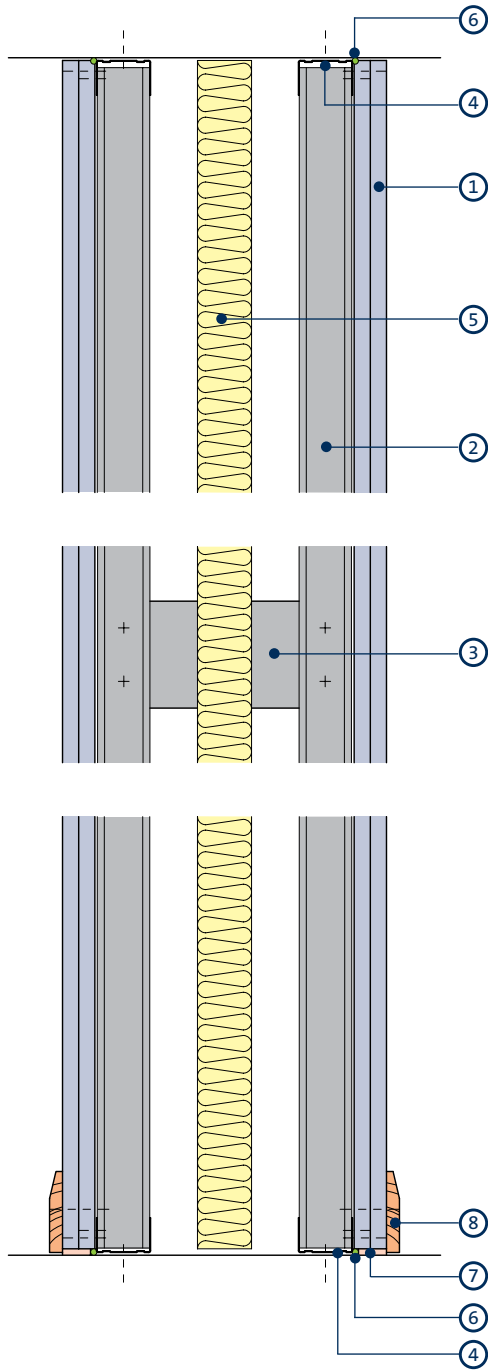

Head and base

- 1 Gyproc plasterboard
- 2 Gyproframe 'C' Stud
- 3 Gyproframe 99 FC 50 Fixing Channel (at 1200mm vertical centres)
- 4 Gyproframe Folded Edge Standard Floor & Ceiling Channel
- 5 Isover insulation suitably supported at head
- 6 Gyproc Sealant
- 7 Bulk fill with Gyproc jointing materials (where gap exceeds 5mm)

2

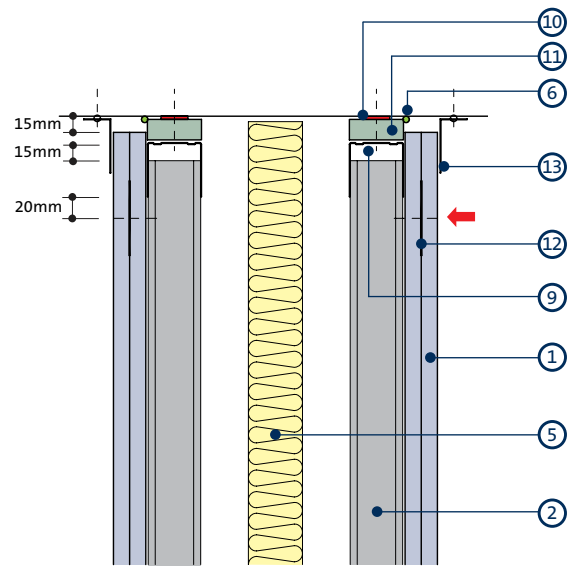

Deflection head for 15mm downward movement and 60 minutes fire resistance

- 8 Skirting
- 9 Gyproframe Deep Flange Floor & Ceiling Channel suitable fixed through fire-stop to structure
- 10 Gyproc FireStrip
- 11 Gyproc CoreBoard or Glasroc F FIRECASE
- 12 Gyproframe GFS1 Fixing Strap
- 13 Gyproframe Steel Angle

NB No fixings should be made through the boards into the flanges of the head channel. The arrow (←) denotes the position of the uppermost board fixing, which should be made into Gyproframe GFS1 Fixing Strap (or stud nogging in C04. S01. P116 – construction detail 16). Continuous Gyproc FireStrip must be installed as shown to maintain fire performance. Where there is a need for a deflection head in a 90 minute wall, the 120 minute solution can be used (refer to Partitions introduction C04. S01. P116 – construction detail 16) or alternatively, please contact the Gyproc Technical Department for further guidance.

3

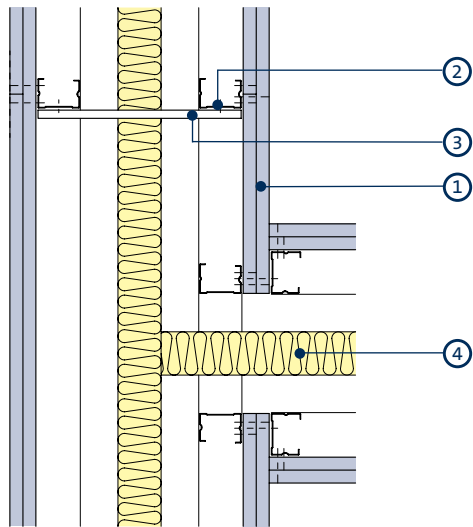

'T' Junction

4

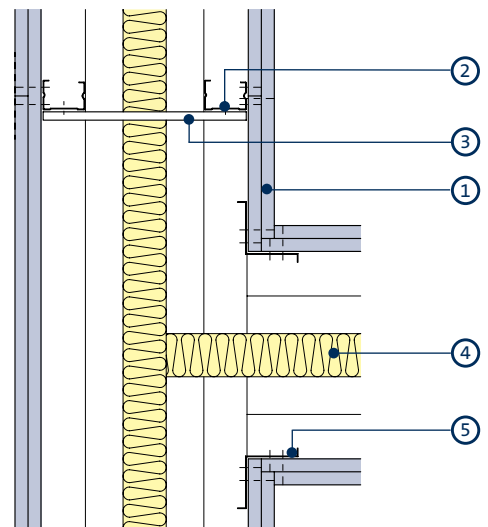

Alternative 'T' junction with Gypframe GA5 Internal Fixing Angle

5

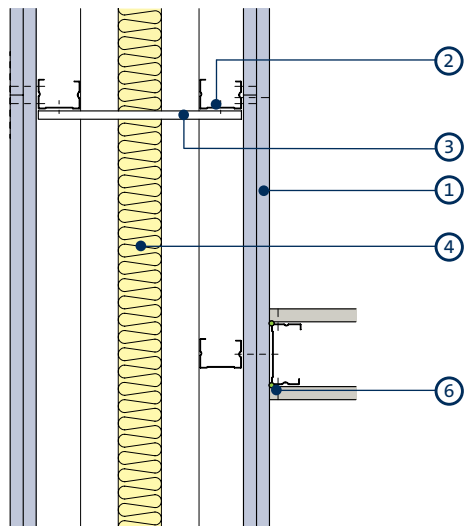

'T' junction with GypWall partition

6

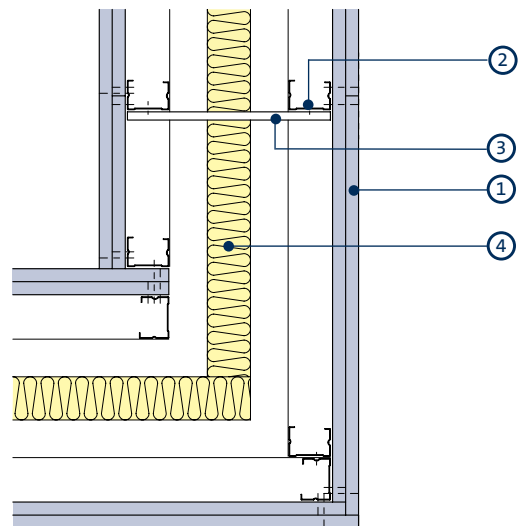

Internal / external corner

- 1 Gyproc plasterboard
- 2 Gypframe 'C' Stud
- 3 Gypframe 99 FC 50 Fixing Channel

- 4 Isover insulation
- 5 Gypframe GA5 Internal Fixing Angle
- 6 Gyproc Sealant

GypWall QUIET system components

Gypframe metal components

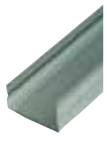

Gypframe 'C' Studs (48 S 50)

Vertical stud providing acoustic and structural performances designed to receive fixing of board to one side along with a suitable Gyproc brace fixed to the other side.

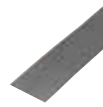

Gypframe GF51 Fixing Strap

Used to support horizontal board joints.

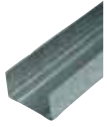

Gypframe Folded Edge Standard Floor & Ceiling Channels (50 FEC 50)

Standard floor and ceiling channels for retaining the Gypframe studs at floor and ceiling junctions and around openings to heights not exceeding 4200mm.



Gypframe GA5 Internal Fixing Angle

Steel angle providing framing stability and board support.

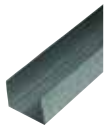

Gypframe Deep Flange Floor & Ceiling Channels (50 DC 60)

Floor and ceiling channels with deep flanges for retaining the Gypframe studs at floor and ceiling junctions for partitions 4200mm to 8000mm high. Also used around openings and in deflection heads (maximum 30mm deflection).



Gypframe GA6 Splayed Angle

Steel angle providing framing stability and board support.

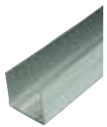

Gypframe Extra Deep Flange Floor & Ceiling Channels (50 EDC 70)

Floor and ceiling channels with extra deep flanges for retaining the Gypframe studs at floor and ceiling junctions for partitions over 8000mm high. Also used around openings and in deflection heads (maximum 50mm deflection).

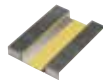

Gypframe Service Support Plate

For installation of 18mm plywood within a partition cavity to support medium to heavyweight fixtures.



Gypframe 99 FC 50 Fixing Channel

A versatile metal fixing channel used to support medium weight fixtures on walls. Also used to cross-brace the two rows of Gypframe stud.

Board products



Gyproc SoundBloc¹

Gypsum plasterboard with a high density core for enhanced sound insulation performance.



Gyproc Duraline¹

Gypsum plasterboard with fire resistant additives and a high density core for enhanced sound insulation and impact resistance performance.



Gyproc FireLine¹

Gypsum plasterboard with fire resistant additives.



Glasroc F FIRECASE

Non-combustible glass-reinforced gypsum board used to form deflection head.

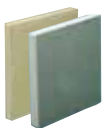

Gyproc Plank

Standard gypsum plasterboard located as an inner layer.



Gyproc CoreBoard

Gypsum plasterboard with fire and moisture resistant additives used to form deflection head.

¹ Also available in a Moisture Resistant (MR) version. MR boards are specified in intermittent wet use areas.

GypWall QUIET system components (continued)

Fixing products



Gyproc Drywall Screws

Corrosion resistant self-tapping steel screws for fixing board-to-timber and board-to-metal framing less than 0.8mm thick.



Gyproc Wafer Head Drywall Screws

Corrosion resistant self-tapping steel screws for fixing metal to metal framing less than 0.8mm thick.



Gyproc Collated Drywall Screws

Corrosion resistant self-tapping steel screws for fixing board-to-timber and board-to-metal framing less than 0.8mm thick.

Plasterboard accessories



Gyproc Jointing Materials

Jointing compounds, ready mixes and adhesives for reinforcement and finishing of board joints.



Gyproc FireStrip

A soft extruded linear intumescent gap sealer to maintain fire resistance located directly to the underside of the soffit when forming a deflection head.



Gyproc Control Joint

To accommodate structural movement of up to 7mm.



Gyproc Sealant

Used to seal air paths for optimum sound insulation.



Gyproc edge and angle beads

Protecting and enhancing board edges and corners



Gyproc Paper Joint Tape

A paper tape designed for reinforcement of flat joints or internal angles.



Gyproc Drywall Primer

Used to prepare for painting.
Tub contents 10 litre



Gyproc Drywall Sealer

Used to provide vapour control.
Tub contents 10 litre

Finishing products



Gyproc Skimcoat

To provide a plaster skim finish on most common backgrounds including undercoat plasters and plasterboard. Can provide enhanced acoustic performance.



Gyproc Carlite Finish

To provide a plaster skim finish on most common backgrounds including undercoat plasters and plasterboard. Can provide enhanced acoustic performance.



Gyproc Carlite Ultra Finish

Offers all the benefits of Gyproc Skimcoat and Gyproc Carlite Finish with a reduced set time of 90-120mins, making it ideal for smaller jobs.



Gyproc Magnetic Plaster

To provide a plaster skim finish that provides an attraction to magnets used to finish a wide range of backgrounds, including undercoat plasters and plasterboard.



Plaster accessories

Designed for the reinforcement and finishing of board joints before plaster skimming.

GypWall QUIET system components (continued)

Insulation products



Isover Acoustic Roll

Glass mineral wool for enhanced acoustic and thermal performance.



Isover Acoustic Slab

Glass mineral wool to achieve acoustic performance.

GypWall QUIET installation overview

This is intended to be a basic description of how the system is built.
For detailed installation guidance refer to the [Gyproc Installation Guide](#).



Gyproframe Floor & Ceiling Channels are suitably fixed to the floor and soffit in two rows.



Gyproframe 'C' Studs are suitably fixed to abutments in two rows.



The perimeter of each frame is then sealed with Gyproc Sealant.



Gyproframe 'C' Studs are then friction fitted into the Gyproframe Floor & Ceiling Channels at the required centres. Door openings are constructed to the Heavy and Severe Duty Rating door detail.



The two frameworks are braced with Gyproframe 99 FC 50 Fixing Channel attached to the Gyproframe 'C' Studs with Gyproc Wafer Head Drywall Screws, two screws per junction.



Mechanical and electrical services can be located within the partition cavity.



Isover insulation is added to the partition cavity for increased acoustic performance.



Gyproc plasterboards are then fixed to the Gyproframe framework with Gyproc Drywall Screws.



Additional information

For full installation details, refer to the [Gyproc Installation Guide](#), available to download from gyproc.ie